

2

# TOOLKITS



**PERSONALICE EL COLOR**  
*CUSTOMIZE THE COLOUR*  
**PERSONNALISEZ LA COULEUR**



**Personalice el color de sus cajas, carros y mobiliario de taller seleccionando entre 4 colores disponibles, para:**

- Potenciar la imagen corporativa de su empresa.
- Diferenciar visualmente los equipamientos por aplicaciones o divisiones.

Todos ellos disponibles en rojo (RAL 2002\*), verde (RAL 6032\*), azul (RAL 5017\*) y amarillo (RAL 1003\*).

\* Colores aproximados

**Customize the colour of your tool boxes, trolleys and workshop equipment by selecting from the 4 available colours:**

- Strengthen the corporate image of your company.
- Visually distinguish your equipment by application or division.

All available in red (RAL 2002\*), green (RAL 6032\*), blue (RAL 5017\*) and yellow (RAL 1003\*).

\* Approximate colors

**Vous pouvez personnaliser la couleur de vos caisses, servantes et mobilier d'atelier en sélectionnant entre les 4 couleurs disponibles, afin de:**

- Distinguer visuellement les équipements par applications ou divisions.
- Améliorer l'image corporative de votre société.

Sont toutes disponibles en rouge (RAL 2002\*), vert (RAL 6032\*), bleu (RAL 5017\*) et jaune (RAL 1003\*).

\* Couleurs approximatives

**SISTEMAS ANTIVUELCO**  
*ANTI-OVERTURN SYSTEMS*  
**SYSTÈME ANTI-RENVERSEMENT**



**EGA Master ha ampliado su gama de sistemas ANTIVUELCO dentro de su extensa variedad de armarios-carros de herramientas y cofres.**

- 1 El Sistema OODO ("Only One Drawer Open") le permite al usuario abrir un solo cajón cada vez. Las referencias que poseen este sistema son la 51025 y 51039.
- 2 Por otro lado, el resto de referencias llevan incorporado el sistema de seguridad de apertura lateral e individual de cajones ANTIVUELCO.

**EGA Master has widened its range of ANTI-OVERTURN systems within its vast variety of roller cabinets and tool chests.**

- 1 The OODO System ("Only One Drawer Open") allows the user to open only one drawer each time. The references which have this system are 51025 and 51039.
- 2 All other references are equipped with the ANTI-OVERTURN security system with individual and lateral open button in each tray.

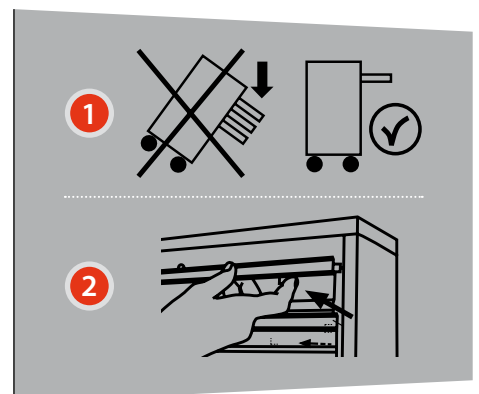

**Dans sa grande variété de servantes à roues et coffres, EGA Master a élargi sa gamme de système ANTI-RENVERSEMENT.**

- 1 Le système OODO ("Only One Drawer Open") permet à l'utilisateur d'ouvrir un seul tiroir chaque fois. Les références qui possèdent ce système sont : 51025 et 51039.
- 2 D'autre part, le reste des références intègrent le système de sécurité d'ouverture latérale et individuelle des tiroirs ANTI-RENVERSEMENT.





PCS.	Composición / Composition / Composition	Descripción / Description / Description	
4	67202, 67203, 67204, 67205	Palanca cabeza curva / Pry bar	-
29	55266, 55267, 55268, 55269, 55270, 55271, 55272, 55273, 55274, 55275, 55276, 55277, 55278, 55279, 55280, 55281, 55282, 55283, 55284, 55285, 55286, 55287, 55288, 55289, 55290, 55291, 55292, 55293, 55294	Blister de puntas de impacto / Blister of impact bits	5/16", 5 pcs
31	66944	Set de puntas Phillips®-Pozidriv® / Kit of bits Phillips®-Pozidriv®	30 pcs
2	66261, 66262	Adaptador portapuntas / Magnetic bit holder	
3	69570, 69572, 69574	Sargentos G / G Clamps	-
7	62847, 62848, 62849, 62850, 62851, 62853, 62856	Cinceles mecánicos / Flat cold chisel	
103	61322, 61311, 63974, 61312, 63975, 61313, 61314, 61315, 61316, 61317, 61318, 61319, 61320, 61321, 63977, 63978, 63979, 63980, 63981, 63982, 63983, 63984, 63985, 63986, 63987, 60420, 60421, 60422, 60423, 60424, 60425, 60426, 60427, 60428, 60429, 60430, 63989, 63990, 63991, 63992, 63993, 63994, 63995, 63996, 63997, 63998, 67640, 67641, 67642, 67643, 67644, 67645, 67646, 67647, 67648, 67649, 67650, 67651, 67652, 67660, 67661, 67662, 67663, 67664, 67665, 67666, 67667, 67668, 67669, 67670, 67674, 67675, 67676, 67677, 67678, 67679, 67680, 67681, 67682, 67683, 67684, 67689, 67690, 67691, 67692, 67693, 67694, 67695, 67696, 56015, 56017, 56018, 56019, 56020, 56021, 56023, 56024, 56025, 56026, 56027	Llave vaso / Socket wrench	
38	66733, 66734, 66735, 66736, 66737, 66738, 66739, 66740, 66741, 66742, 66744, 66745, 66746, 66747, 66748, 66749, 66750, 66751, 66752, 66753, 66754, 66755, 66756, 55697, 55698, 55699, 55700, 55670, 55671, 55672, 55673, 55674, 55675, 55676, 55677, 55678, 55679, 66743	Punta atornilladora con vaso / Socket bit	1/4"
	65880	Adaptador para llaves de vaso / Adapter for socket wrenches	
	66732	Destornillador portavasos / Socket holder	
1	62603	Llave de carraca reversible / Reversible ratchet handle	
	61438	Mango corredizo / Sliding -T- handle	
	61435	Articulación universal / Universal joint	
4	61442, 61454, 61443, 61444	Alargadera / Extension	
1	61445	Alargadera flexible / Flexible handle	1/4"
	65874	Mango flexible / Flexible handle	
56	67541, 67542, 67543, 67544, 67545, 67546, 67547, 67548, 67549, 67550, 67551, 67552, 67553, 67554, 67555, 67556, 67557, 67558, 67559, 67620, 67621, 67622, 67623, 67624, 67625, 67626, 67627, 67628, 67629, 67630, 67631, 67632, 67633, 67634, 67635, 67636, 67637, 67638, 67639, 67640, 67641, 67642, 67643, 67644, 67645, 67646, 67647, 67648, 67649, 67650, 67651, 67652, 67653, 67654, 67655, 67656, 67657, 67658, 67659, 67660, 67661, 67662, 67663, 67664, 67665, 67666, 67667, 67668, 67669, 67670, 67671, 67672, 67673, 67674, 67675, 67676, 67677, 67678, 67679, 67680, 67681, 67682, 67683, 67684, 67685, 67686, 67687, 67688, 67689, 67690, 67691, 67692, 67693, 67694, 67695, 67696, 55701, 55702, 55703, 55680, 55681, 55682, 55683, 55684, 55685, 55686, 55687	Llave de vaso / Socket wrench	
48	66760, 66761, 66762, 66763, 66764, 66765, 66766, 66767, 66768, 66769, 66770, 66771, 66772, 66773, 66774, 66775, 66776, 66777, 66778, 66779, 66780, 66781, 66782, 66783, 66784, 66785, 66786, 66787, 66788, 66789, 66790, 66791, 66792, 66793, 66794, 66795, 66796, 55701, 55702, 55703, 55680, 55681, 55682, 55683, 55684, 55685, 55686, 55687	Punta atornilladora con vaso / Socket bit	
2	65884, 65881	Adaptador para llaves de vaso / Adapter for socket wrenches	
	61460, 61461	Llave de vaso para bujías / Spark plug socket	3/8"
22	55710, 55711, 55712, 55713, 55714, 55715, 55716, 55717, 55718, 55719, 55720, 55721, 55724, 55725, 55726, 55727, 55728, 55729, 55730, 55731, 55732, 55733	Llave fija Crow Foot / Open end Crow Foot wrench	
20	55736, 55737, 55738, 55739, 55740, 55741, 55742, 55743, 55744, 55745, 55746, 55750, 55751, 55752, 55753, 55754, 55755, 55756, 55757, 55758	Llave fija hexagonal Crow Foot / Hexagonal Crow Foot wrench	
	61429	Llave de carraca reversible / Reversible ratchet handle	
1	61439	Mango corredizo en T / Sliding T handle	
	61436	Articulación universal / Universal joint	
2	61447, 61450	Alargadera / Extension	
1	61409	Berbiquí / Speeder handle	
	65875	Mango articulado / Hinged handle	
94	61800, 61801, 61802, 61803, 61804, 61805, 61806, 61807, 61808, 61809, 61810, 61811, 61812, 61813, 61814, 61815, 61816, 61817, 61818, 61819, 61820, 61821, 61822, 61823, 60460, 60461, 60462, 60463, 60464, 60465, 60466, 60459, 60467, 60468, 60469, 60470, 60471, 60472, 60473, 60474, 60475, 60476, 60477, 60478, 67780, 67781, 67782, 67783, 67784, 67785, 67786, 67787, 67788, 67789, 67791, 67792, 67793, 67794, 67795, 67796, 67797, 67798, 67799, 67800, 67805, 67806, 67807, 67808, 67809, 67810, 67811, 67812, 67813, 67814, 67815, 67816, 67817, 67818, 55795, 55796, 55797, 55798, 55799, 55800, 55801, 55802, 55803, 55804, 55805, 55806, 55807, 55808, 55809, 55810	Llave de vaso / Socket wrench	
62	66801, 66802, 66803, 66804, 66805, 66806, 66807, 66808, 66809, 66810, 66811, 66812, 66813, 66814, 66815, 66816, 66817, 66818, 66819, 66820, 66821, 66822, 66823, 66824, 66825, 66826, 66827, 66828, 66829, 66830, 66831, 66832, 66833, 66834, 66835, 66836, 66837, 66838, 66839, 66840, 66841, 55705, 55706, 55707, 55688, 55689, 55690, 55691, 55692, 55693, 55695, 55696, 66842, 65985, 65986, 65987, 65988, 65989, 65990, 65991, 65992, 65993	Punta atornilladora con vaso / Socket bit	1/2"
2	65885, 65882	Adaptador para llaves de vaso / Adapter for socket wrenches	
	61462, 61463	Llave de vaso para bujías / Spark plug socket	
3	61441, 61483, 61484	Mango articulado / Hinged handle	
	61453, 61455, 61458	Alargadera / Extension	
1	61434	Berbiquí / Speeder handle	
	62606	Llave de carraca reversible / Reversible ratchet handle	





PCS.	Composición / Composition / Composition	Descripción / Description / Description	
1	61440	Mango corredizo en T / Sliding T handle	
	61437	Articulación universal / Universal joint	
63	60658, 60603, 60604, 60605, 60606, 60607, 60608, 60609, 60610, 60611, 60612, 60639, 60613, 60614, 60615, 60616, 60617, 60618, 60619, 65213, 65214, 65215, 65216, 65217, 65218, 65219, 65220, 65221, 65222, 65223, 65224, 65225, 65226, 60660, 60661, 60662, 60663, 60664, 60665, 60666, 60667, 60668, 60669, 60670, 60671, 60672, 60673, 60674, 60675, 60676, 56350, 56351, 56352, 56353, 56354, 56355, 56356, 56357, 56358, 56359, 56360, 56361, 56362	Llave de vaso de impacto / Impact socket wrench	1/2"
18	65936, 65937, 65938, 65939, 65940, 65941, 65942, 65943, 65944, 65945, 65946, 65947, 65948, 65949, 65950, 65951, 65952, 65953	Puntas atornilladoras de impacto con vaso / Impact socket bit	
2	60698, 60699	Adaptador (vasos de impacto) / Adapter (impact socket wrench)	
1	60705	Articulación universal (vasos de impacto) / Universal joint (impact socket wrench)	
	60711	Alargadera (vasos de impacto) / Extension (impact socket wrench)	
79	60501, 60502, 60503, 60504, 60505, 60506, 60507, 60508, 60509, 60510, 60511, 60512, 60513, 60514, 60515, 60516, 60517, 60518, 60519, 60520, 60521, 60522, 60523, 60524, 67565, 67566, 67567, 67568, 67569, 67570, 67571, 67572, 67573, 67574, 67575, 67576, 67577, 67578, 67579, 67580, 67581, 67582, 67583, 67584, 67585, 67586, 67587, 67588, 67595, 67596, 67597, 67598, 67599, 67600, 67602, 67603, 67604, 67605, 67607, 67608, 67610, 67612, 60526, 60527, 60528, 60529, 60530, 60531, 60500, 60532, 60533, 60534, 60535, 60536, 60537, 60538, 60539, 60540, 60541	Llave de vaso / Socket wrench	
2	65883, 65886	Adaptador para llaves de vaso / Adapter for socket wrenches	
1	61859	Llave de carraca reversible / Reversible ratchet handle	
2	61473, 61456	Mango articulado / Hinged handle	
1	61864	Mango corredizo en T / Sliding T handle	
	61860	Articulación universal / Universal joint	3/4"
2	61865, 61866	Alargadera / Extension	
80	63879, 60620, 60621, 60622, 60623, 60624, 60625, 60626, 60627, 60628, 60629, 60630, 60631, 60632, 60633, 60634, 60635, 60636, 60637, 63880, 60638, 63881, 65227, 65228, 65229, 65230, 65231, 65232, 65233, 65234, 65235, 65236, 65237, 65238, 65239, 68689, 65240, 65241, 65242, 65243, 65244, 68688, 60679, 60680, 60681, 60682, 60683, 60684, 60685, 60686, 60687, 60688, 60689, 60690, 60691, 63895, 63896, 63897, 65245, 65246, 65247, 65248, 65249, 65250, 65251, 65252, 56363, 56364, 56365, 56366, 56367, 56368, 56369, 56370, 56371, 56372, 56373, 56374, 56375, 56376	Llave de vaso de impacto / Impact socket wrench	
2	60700, 60701	Adaptador (vasos de impacto) / Adapter (impact socket wrench)	
1	60706	Articulación universal (vasos de impacto) / Universal joint (impact socket wrench)	
	60714	Alargadera (vasos de impacto) / Extension (impact socket wrench)	
8	61593	Set de extractores de tornillos / Set of screw extractors	8 pcs
2	65555, 65570	Galgas de espesores / Feeler gauge	
6	63498, 63534, 63570, 63606, 63642, 63678	Limas / Files	
1	58641	Linterna táctil / Tactile flashlight	
2	63742, 63299	Arcos de sierra / Hack saws	
7	69612, 69614, 69617, 69750, 69748, 55327, 69752	Martillos / Hammers	
5	61110, 61111, 61112, 61113, 61114	Llave ajustable / Adjustable wrench	
4	60795, 60796, 60797, 60798	Llave media luna / Half moon spanner	
10	60785, 60786, 60787, 60788, 60789, 60790, 60791, 60792, 60793, 60794	Llave para racores / Flare nut	
71	63965, 63966, 67880, 63967, 67881, 61725, 61726, 61727, 61728, 61729, 61730, 61731, 61732, 61733, 61734, 61735, 61736, 61737, 61738, 61739, 61740, 61741, 61742, 61743, 61744, 61745, 61746, 61747, 61748, 61749, 61750, 60951, 60952, 60953, 60954, 60955, 60956, 67882, 67883, 67953, 67954, 61653, 60340, 60341, 67878, 60342, 60343, 60344, 60345, 60346, 60347, 60348, 60349, 60350, 60351, 60352, 60353, 60354, 60355, 60356, 60357, 60358, 60957, 60958, 60961, 60959, 60962, 60897, 60898, 60899, 60960	Llave combinada / Combination wrench	mm/inch
26	67963, 67967, 61601, 61602, 61603, 61604, 61605, 61606, 61607, 61608, 61609, 61610, 61611, 61612, 61613, 60300, 60302, 60303, 60305, 67943, 60308, 60310, 60311, 60312, 60314, 67946	Llave fija / Open-end wrench	
32	61774, 61775, 61776, 61777, 61778, 61779, 61780, 61781, 61782, 61783, 61784, 61785, 61786, 61787, 67862, 67863, 61790, 60380, 60381, 60382, 60383, 60384, 60385, 60386, 60387, 60388, 60389, 60390, 60391, 60392, 60393, 60394	Llave acodada / Double offset ring wrench	
16	68283, 68284, 68285, 68286, 68287, 68288, 68289, 68290, 68291, 68292, 68293, 68295, 68296, 68297, 68298, 68299	Llave de gancho / Adjustable hook wrench	
11	65089, 65090, 65091, 65092, 65093, 65095, 65096, 65098, 65099, 65100, 65102	Llave de carraca para racores / Ratcheting ring wrench	
9	61301, 61302, 61303, 61304, 61305, 61306, 61308, 61309, 61310	Llave vaso doble articulación / Double ended swivel wrench	
20	61495, 61496	Juego de llaves Allen bola / Set of hexagonal key wrenches ball type	10 pcs, mm/inch
9	56566	Juego de llaves Tamper Torx / Set of Tamper Torx keys	9 pcs
12	63280, 63281, 63282, 63283, 58097, 58098, 58099	Llave de carraca doble Mastergear / Mastergear double ratchet wrench	
20	62710, 62711, 62712, 62713, 62714, 62715, 62716, 62717, 62718, 62719, 62720, 62721, 62722, 62723, 62724, 62725, 62726, 62727, 62728, 62729	Llave combinada Stubby Mastergear / Combination wrench Stubby Mastergear	mm/inch
2	63199, 63205	Cortatubos para plástico / Plastic pipe cutter	
3	61015, 61017, 61018	Llave Heavy Duty / Heavy Duty pipe wrench	
2	61405, 61406	Llave Mastergrip / Mastergrip wrench	

PCS.	Composición / Composition / Composition	Descripción / Description / Description	
2	62965, 62968	Llaves dinámicas / Torque wrenches	-
1	66873	Destornillador dinámico / Torque screwdriver	1/4"
19	66400, 66401, 66403, 66405, 66407, 66448, 66408, 66409, 66449, 66410, 55330, 55331, 55333, 55335, 55337, 55338, 55339, 55340, 55341	Destornilladores mecánicos / Slotted screwdrivers	mm/inch
14	76620, 76621, 76622, 76624, 76625, 76626, 76627, 75063, 75064, 75065, 75067, 75068, 75069, 75081	Destornilladores electricidad / Electrician screwdrivers	1000V, mm/inch
5	66438, 66437, 66443, 66441, 66442	Destornillador Phillips® / Phillips® screwdriver	
	66456, 66472, 66473, 66459, 66460	Destornillador Pozidriv® / Screwdriver Pozidriv®	
3	63954, 63955, 63956	Alicates de bocas semi-redondas y extralargos / Extra-long reach halfround nose pliers	-
9	62241, 62242, 62243, 62244, 62245, 62246, 62247, 62248, 62249	Alicates mini / Mini Pliers	
12	66488, 66489, 66490, 66491, 66492, 66493, 66494, 66495, 66496, 66497, 66498, 66499	Destornilladores Tamper Torx / Screwdrivers Tamper Torx	
11	66501, 66502, 66503, 66504, 66505, 66506, 66507, 55364, 55365, 55368, 55369	Destornilladores punta esfera / Ball point screwdrivers	mm/inch
3	66530, 66531, 66532	Destornilladores Robertson / Screwdrivers Robertson	
6	66525, 55371, 67192, 66526, 67193, 66527	Destornilladores carroceros / Stubby screwdrivers	
17	62331, 62332, 62333, 62337, 62338, 62339, 62340, 62341, 62342, 62343, 62540, 62344, 62370, 62345, 62346, 62348, 62349	Alicates / Pliers	
20	62214, 62215, 62183, 62216, 62217, 62218, 62219, 62182, 62220, 62221, 62222, 62223, 62181, 62224, 62225, 62226, 62227, 62180, 62228, 62229	Alicates Circlips / Circlips pliers	
3	63950, 63951, 63952	Alicates de corte al ras / Flush cutting pliers	
1	61035	Llave de cadena reversible / Reversible chain pipe wrench	
	63371	Escariador manual / Manual reamer	
2	68001, 68003	Abocinador puente / Flaring tool	
1	69501	Cortador de metal / Metallic cutter	
2	65166, 65364	Flexómetros / Measuring tapes	
	65480	Calibre pie de rey / Vernier Caliper	-
1	65588	Recogedor articulado telescópico / Telescopic joint pick up	
	55836	Llave de impacto neumática / Pneumatic impact wrench	
	63915	Cortabridas / Plastic tie cutter	
14	63394, 63395, 63396, 63397, 63398, 63399, 63400, 63415, 63416, 63417, 63418, 63419, 63420, 63421,	Botadores / Punches	
6	63435, 63436, 63437, 63438, 63439, 63440,	Granetes / Center punches	
	62097, 62174	Tenazas Grip / Grip pincers	
2	62624, 62625	Alicate trenzador de alambre / Wire twist plier	
1	62128	Tenaza canal / Box joint plier	
29	61870, 61871, 61872, 61873, 61874, 61875, 61876, 61877, 61878, 61879, 61880, 61881, 61882, 61883, 61884, 61885, 61886, 61887, 61888, 61889, 61890, 61891, 61892, 61893, 61894, 61895, 61768, 61772, 61770	Llaves de pipa / Angled sockets	
26	61530, 61531, 61532, 61533, 61534, 61535, 61536, 61537, 61538, 61539, 61540, 61541, 61542, 61543, 61544, 61545, 61546, 61547, 61548, 61549, 61550, 61551, 61552, 61553, 61554, 61555	Llave combinada articulada Mastergear / Flexible combination wrench Mastergear	mm/inch
3	62090, 62091, 62092	Alicate tipo Ford / Slip joint plier	
	62123, 62124, 62125	Tenaza rusa / Tower pincer	
1	66073	Buscapolos / Voltage tester	
3	62169, 62170, 62171	Tijeras articuladas / Aviation tin snips	-
10	64670	Juego de sacabocados / Hollow punch set	
1	65158	Nivel torpedo / Torpedo spirit level	
18	56200, 56201, 56202, 56203, 56204, 56205, 56206, 56207, 56208, 56209, 56210, 56211, 56212, 56213, 56214, 56215, 56216, 56217,	Llaves fijas extrafinas / Slim open end wrenches	mm/inch
27	66846, 66847, 66848, 66849, 55449, 55450, 55451, 55452, 66850, 66851, 66852, 66853, 66854, 66866, 66867, 66868, 66869, 66870, 66871, 66872, 57684, 57685, 66864, 66865, 55458, 55453, 55457	Destornilladores Microtronic / Screwdrivers Microtronic	
5	56230, 56231, 56232, 56233, 56234	Llaves estrella dos bocas extrafina compensada a 15° / Slim double ring wrenches 15° bent	
	56235, 56236, 56237, 56238, 56239	Llaves estrella plana de dos bocas extrafinas / Slim flat double ring wrenches	
1	87628	Limpiador multiusos / Multi-purpose cleaner	250 ml
	63988	Cinta de señalización de seguridad / Safety hazard signs tape	-

■ ≈ 1000 PCS.

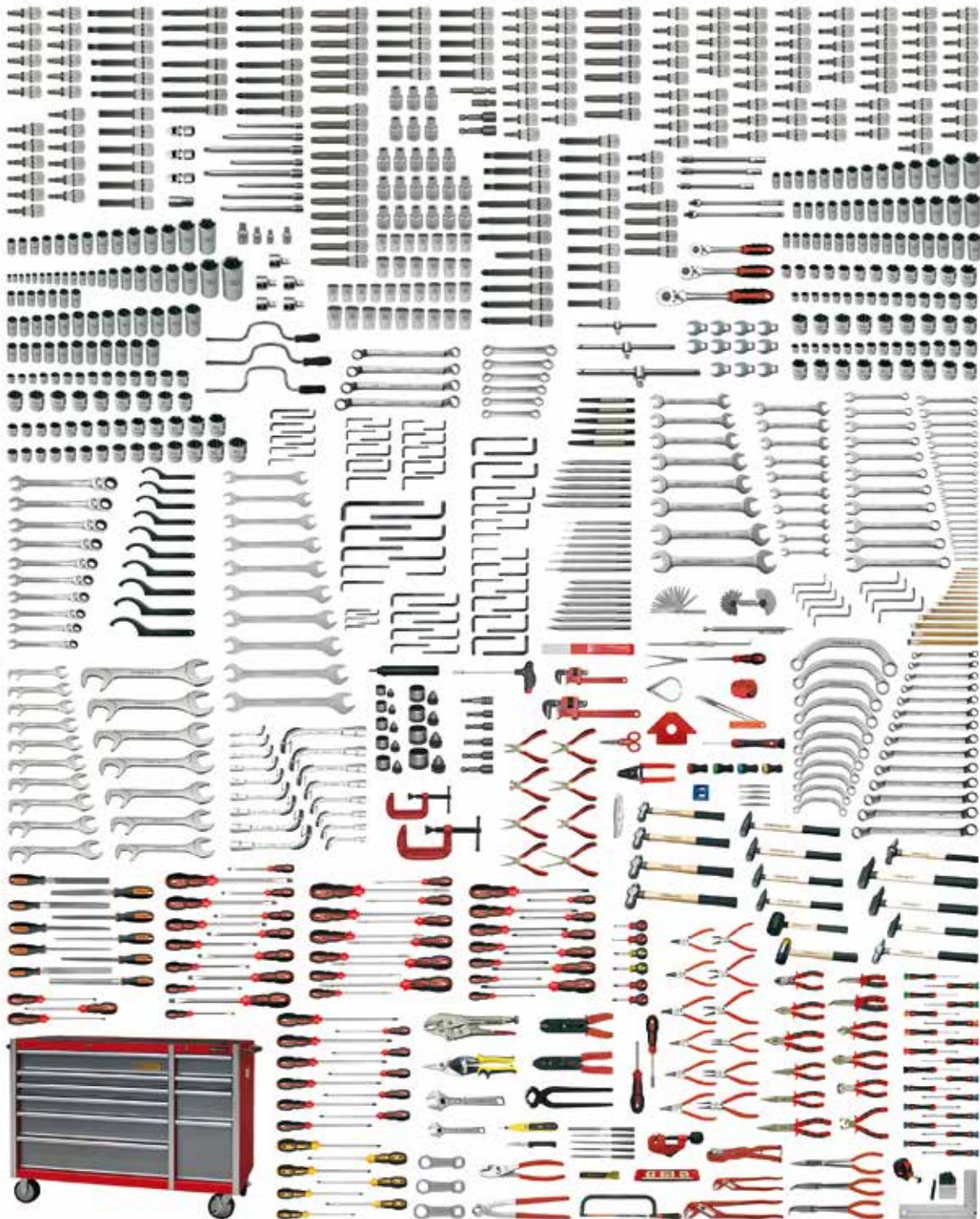
■ MM



COD.	PCS.		Medidas en / Sizes in / Mesures en	
51671				130
51672	1006	57060	mm	320
51673		50954 (3)		480



PCS.	Composición / Composition / Composition	Descripción / Description / Description	
1	65880		1/4"
2	65881, 65884	Adaptador para llaves de vaso / Adapter for socket wrenches	3/8"
	65882, 65885		1/2"
	62772		1/4"
1	62773	Adaptadores cuadrado - hexagono / Square - hex adapters	3/8"
	62774		1/2"
3	57315, 57316, 57317	Adaptadores de par / Torque adapters	3/8"
	62775	Adaptadores portapuntas / Bit holders	
1	66264	Adaptadores portapuntas magnéticos / Magnetic bit holders	1/4"
	65603	Agujas de trazar / Scribers	-
	61442, 61443, 61444, 61445		1/4"
4	61447, 61450, 62118, 62732	Alargaderas / Extensions	3/8"
	61453, 61455, 61458, 62119		1/2"
11	62331, 62333, 62337, 62339, 62340, 62341, 62342, 62343, 62344, 62346, 62349	Alicates / Pliers	
15	62180, 62181, 62182, 62183, 62215, 62216, 62219, 62220, 62223, 62224, 62227, 62228, 63954, 63955, 63956	Alicates Circlips / Circlips pliers	
2	62493, 62494	Alicates de terminales / Crimping pliers	-
9	62241, 62242, 62243, 62244, 62245, 62246, 62247, 62248, 62249	Alicates mini / Mini Pliers	
	62090	Alicates tipo Ford / Slip joint pliers	
	63745	Arcos de sierra / Hack saws	
	61435		1/4"
1	61436	Articulación universal / Universal joint	3/8"
	61437		1/2"
	61408		1/4"
	61409	Berbiquí / Speeder Handle	3/8"
	61434		1/2"
14	63387, 63388, 63389, 63390, 63391, 63392, 63393, 63408, 63409, 63410, 63411, 63412, 63413, 63414	Botadores / Punches	
	62876	Buriles planos / Crosscut chisels	
1	66074	Buscapolos / Voltage tester	
13	62847, 62848, 62849, 62850, 62851, 62853, 62854, 62855, 62856, 62857, 63320, 63321, 63472	Cinceles / Chisels	-
2	65622, 65627	Compases / Calipers	
1	63915	Cortabridas / Plastic tie cutters	
	69501	Cortadores / Cutters	
2	63170, 63199	Cortatubos / Tube cutters	
1	66732	Destornillador portavasos / Socket holder	1/4"
9	57675, 57676, 57677, 57678, 57679, 57680, 57681, 57682, 57683	Destornilladores acodados / Offset screwdrivers	
4	66525, 66526, 66527, 66529	Destornilladores carroceros / Stubby screwdrivers	
12	66509, 66510, 66511, 66512, 66513, 66514, 66515, 66516, 66517, 66518, 66519, 66520	Destornilladores de vaso / Socket screwdrivers	
11	66411, 66412, 66420, 66421, 66422, 66423, 66424, 66425, 66426, 66427, 66428	Destornilladores electricista / Electrician screwdrivers	
14	66399, 66400, 66401, 66402, 66403, 66404, 66405, 66406, 66407, 66408, 66409, 66410, 66448, 66449	Destornilladores mecánicos / Slotted screwdrivers	
20	57684, 66846, 66847, 66848, 66849, 66850, 66851, 66852, 66853, 66854, 57685, 66864, 66865, 66866, 66867, 66868, 66869, 66870, 66871, 66872	Destornilladores Microtronic / Microtronic screwdrivers	
8	66437, 66438, 66439, 66440, 66441, 66442, 66443, 67192	Destornilladores Phillips® / Phillips® screwdriver	
2	66249, 66731	Destornilladores portapuntas / Bitholder screwdrivers	
8	66456, 66457, 66458, 66459, 66460, 66472, 66473, 67193	Destornilladores Pozidriv® / Pozidriv® screwdrivers	
3	66530, 66531, 66532	Destornilladores Robertson / Screwdrivers Robertson	
13	66487, 66488, 66489, 66490, 66491, 66492, 66493, 66494, 66495, 66496, 66497, 66498, 66499	Destornilladores Tamper Torx / Screwdrivers Tamper Torx	
1	63085	Escariadores / Reamers	-
2	63701, 63709	Escofinas / Rasps	
1	65766	Escuadra magnética para soldadura / Magnetic welding square	
2	65768, 65813	Escuadras / Squares	
5	61586, 61587, 61588, 61589, 61590	Extractores de tornillos / Screw extractors	
1	65171	Flexómetros / Measuring tapes	
2	65559, 65571	Galgas / Gauges	
6	63429, 63430, 63431, 63432, 63433, 63434	Granetes / Center punches	
1	65852	Juegos de golpe números / Punches numbers	
13	63504, 63540, 63576, 63612, 63648, 63672, 63684, 63692, 63714, 63715, 63717, 63718, 63719	Limas / Files / Limes	
1	58641	Linternas / Flashlights	
18	61774, 61775, 61776, 61777, 61778, 61779, 61780, 61781, 61782, 61783, 61784, 61785, 61786, 61787, 67843, 67844, 67845, 67855	Llaves acodadas / Double offset ring wrenches	
2	61109, 61112	Llaves ajustables / Adjustable wrenches	

PCS.	Composición / Composition / Composition	Descripción / Description / Description	
31	61725, 61726, 61727, 61728, 61729, 61730, 61731, 61732, 61733, 61734, 61735, 61736, 61737, 61738, 61739, 61740, 61741, 61742, 61743, 61744, 61745, 61746, 61747, 61748, 61749, 61750, 63965, 63966, 63967, 67880, 67881	Llaves combinadas / Combination wrenches	-
1	62603 62604 62606	Llaves de carraca reversible / Reversible ratchet handles	1/4" 3/8" 1/2"
10	68283, 68284, 68285, 68286, 68287, 68288, 68289, 68290, 68291, 68292	Llaves de gancho / Hook spanners	-
17	61870, 61871, 61872, 61873, 61874, 61875, 61876, 61877, 61878, 61879, 61880, 61881, 61882, 61883, 61884, 61885, 61886	Llaves de pipa / Angled sockets	-
68	55813, 55814, 56015, 56017, 56018, 56019, 56020, 56021, 56023, 56024, 56025, 56026, 56027, 57165, 57166, 57167, 57168, 57169, 57170, 61311, 61312, 61313, 61314, 61315, 61316, 61317, 61318, 61319, 61320, 61321, 61322, 63974, 63975, 63977, 63978, 63979, 63980, 63981, 63982, 63983, 63984, 63985, 63986, 63987, 67640, 67641, 67642, 67643, 67644, 67645, 67646, 67647, 67648, 67649, 67650, 67651, 67652, 67660, 67661, 67662, 67663, 67664, 67665, 67666, 67667, 67668, 67669, 67670		1/4"
77	57171, 57172, 57173, 57174, 57175, 57176, 57177, 57178, 61343, 61344, 61345, 61346, 61347, 61348, 61349, 61350, 61351, 61352, 61353, 61354, 61355, 61356, 61357, 67539, 67540, 67541, 67542, 67543, 67544, 67545, 67546, 67547, 67548, 67549, 67550, 67551, 67552, 67553, 67554, 67555, 67556, 67557, 67558, 67559, 67560, 67561, 67705, 67706, 67707, 67708, 67709, 67710, 67711, 67712, 67713, 67714, 67715, 67716, 67717, 67719, 67720, 67725, 67726, 67727, 67728, 67729, 67730, 67731, 67732, 67733, 67734, 67735, 67736, 67737, 67738, 67739, 67740	Llaves de vaso / Socket wrenches	3/8"
116	55795, 55796, 55797, 55798, 55799, 55800, 55801, 55802, 55803, 55804, 55805, 55806, 55807, 55808, 55809, 55810, 55811, 55833, 55834, 57179, 57180, 57181, 57182, 57183, 57184, 57185, 57186, 57187, 61380, 61381, 61382, 61383, 61384, 61385, 61386, 61387, 61388, 61389, 61390, 61391, 61392, 61393, 61394, 61395, 61396, 61397, 61398, 61399, 61400, 61401, 61402, 61403, 61800, 61801, 61802, 61803, 61804, 61805, 61806, 61807, 61808, 61809, 61810, 61811, 61812, 61813, 61814, 61815, 61816, 61817, 61818, 61819, 61820, 61821, 61822, 61823, 65044, 65045, 65046, 65047, 65048, 65049, 65050, 65051, 65052, 65053, 65054, 65055, 65056, 65057, 67770, 67771, 67772, 67773, 67774, 67775, 67780, 67781, 67782, 67783, 67784, 67785, 67786, 67787, 67788, 67789, 67791, 67792, 67793, 67794, 67795, 67796, 67797, 67798, 67799, 67800		1/2"
6	57718, 57719, 57720, 57721, 57722, 57723	Llaves estrella planas Torx / Double ended flat ring spanners Torx	-
16	61701, 61702, 61703, 61704, 61705, 61706, 61707, 61708, 61709, 61710, 61711, 61712, 61713, 67917, 67963, 67967	Llaves fijas / Open-end wrenches	-
3	57211, 57212, 57213	Llaves fijas Crowfoot / Open end Crowfoot wrenches	1/4"
8	55710, 55711, 55712, 55713, 55714, 55715, 55716, 55717		3/8"
10	56200, 56201, 56202, 56203, 56204, 56205, 56206, 56207, 56208, 56209	Llaves fijas extrafinas / Slim open end wrenches	-
17	58520, 58521, 58522, 58523, 58524, 58525, 58526, 58527, 58528, 58529, 58530, 58531, 58532, 58533, 58534, 58535, 58536	Llaves fijas micromecánicas a 15° y 75° / 15° and 75° micromech open end wrenches	-
31	61525, 61526, 61621, 61622, 61623, 61624, 65306, 65307, 65308, 65309, 65310, 65311, 65312, 65313, 65330, 65331, 65332, 65519, 65958, 65959, 65960, 67300, 67301, 67302, 67303, 67304, 67305, 67493, 67494, 67495, 67496	Llaves hexagonales / Hexagonal key wrenches	-
10	61530, 61531, 61532, 61533, 61534, 61535, 61536, 61537, 61538, 61539	Llaves mastergear articuladas / Mastergear joint wrenches	-
11	57155, 57156, 57157, 57158, 57159, 57160, 57161, 57162, 57163, 60795, 60798	Llaves media luna / Half moon spanners	-
2	61001, 61004	Llaves Stillson / Stillson pipe wrenches	-
20	56544, 56545, 56546, 56547, 56548, 56549, 56550, 56551, 56552, 56553, 56554, 56556, 56557, 56558, 56559, 56560, 56561, 56562, 56563, 56564	Llaves Tamper Torx / Tamper Torx keys	-
19	65333, 65334, 65335, 65336, 65337, 65338, 65339, 65340, 65341, 65342, 65343, 65344, 65346, 65347, 65348, 65349, 65350, 67801, 67802	Llaves Torx / Torx keys	-
	69504	Magnetizador-desmagnetizador / Magnetizer-demagnetizer	-
	61438		1/4"
1	61439	Mango correrizo en T / Sliding "T" handle	3/8"
	61440		1/2"
	65874	Mango articulado / Swivel handle	1/4"
	65875		3/8"
15	55326, 69521, 69601, 69603, 69612, 69613, 69614, 69617, 69618, 69620, 69622, 69675, 69681, 69701, 69712	Martillos / Hammers	-
1	69525	Navajas / Penknives	-
	65158	Nivel magnético torpedo / Torpedo Magnetic level	-
4	69530, 69531, 69532, 69533	Pinzas / Tweezers	-
	66049, 66052, 66053, 66054	Portatornillos magnéticos / Magnetic screwdrivers	-
1	55265	Punta portavasos / Socket holder bit	-
	58162	Puntas atornilladoras / Bits	-
61	53000, 53001, 53002, 53003, 53004, 53005, 53006, 53007, 53008, 53009, 53010, 53011, 53013, 53015, 53016, 53017, 53019, 53020, 53021, 53023, 53024, 53025, 53034, 53035, 53036, 53037, 53038, 53039, 53041, 53042, 53043, 53044, 53045, 53046, 53047, 53048, 53049, 53050, 55697, 55698, 55699, 55700, 58900, 66729, 66730, 66733, 66734, 66735, 66736, 66737, 66738, 66739, 66740, 66741, 66742, 66743, 66744, 66745, 66746, 66747, 67164	Puntas atornilladoras con vaso / Socket bits	1/4"

PCS.	Composición / Composition / Composition	Descripción / Description / Description	
63	53063, 53065, 53066, 53067, 53068, 53069, 53070, 53071, 53072, 53074, 53075, 53076, 53078, 53079, 53080, 53082, 53083, 53084, 53086, 53087, 53088, 53089, 53098, 53099, 53100, 53101, 53102, 53103, 55701, 55702, 55703, 58892, 58893, 58896, 58897, 66760, 66761, 66762, 66763, 66764, 66765, 66766, 66767, 66768, 66769, 66770, 66771, 66772, 66773, 66774, 66775, 66776, 66777, 66778, 66779, 66780, 66781, 66782, 66783, 66784, 66785, 66786, 66787		3/8"
78	53105, 53107, 53108, 53109, 53110, 53115, 53116, 53117, 53118, 53119, 53120, 53121, 53122, 53123, 53124, 53125, 53127, 53128, 53129, 53131, 53132, 53133, 53134, 53136, 53137, 53138, 53139, 53149, 53150, 53151, 53152, 53153, 53154, 53155, 53156, 53157, 53158, 53159, 55704, 55705, 55706, 55707, 55708, 56895, 56896, 56897, 66801, 66802, 66803, 66804, 66805, 66806, 66807, 66808, 66809, 66810, 66811, 66812, 66813, 66814, 66815, 66816, 66817, 66818, 66819, 66820, 66821, 66822, 66823, 66824, 66825, 66826, 66827, 66828, 66829, 66842, 67213, 67214	Puntas atornilladoras con vaso / Socket bits	1/2"
7	57575, 57576, 66269, 66270, 66271, 66279, 66280	Puntas Stecker / Magnetic Stecker	1/4"
1	65783	Punzón / Awl	
10	64671, 64672, 64673, 64674, 64675, 64676, 64677, 64678, 64679, 64680	Recogedor telescópico / Telescopic joint pick up	
2	69570, 69572	Sacabocados / Hollow punches	
6	62123, 62146, 62177, 62284, 62793, 62795	Sargentos / Clamps	-
	62170	Tenazas / Pincers	
	69534	Tijeras / Tin snips	
1	65846	Tijeras electricista / Electrician's scissors	
	87628	Vaso adaptador para puntas / Square drive bit retainer	1/4"
	63988	Limpiador multiusos / Multi-purpose cleaner	250 ml
		Cinta de señalización de seguridad / Safety hazard signs tape	-



# EGGA Master

## ART IN INNOVATION

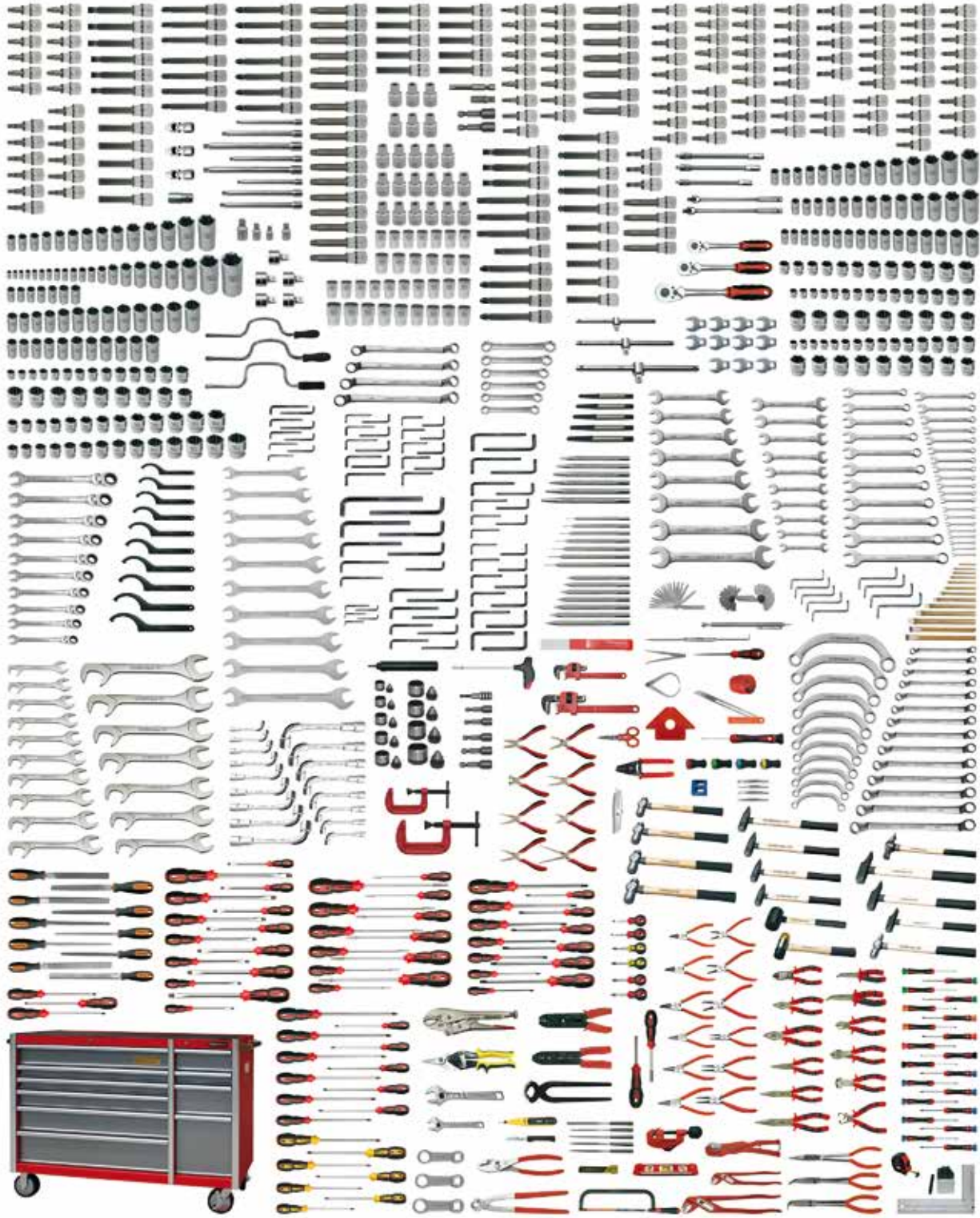

INCH



COD.	PCS.		Medidas en / Sizes in / Mesures en	
51713				120
51714	1003	57060	inch	310
51715		50954 (3)		470

Si no encuentra el artículo que necesita, consúltenos en [consulta@egamaster.com](mailto:consulta@egamaster.com) o en [www.egamaster.com](http://www.egamaster.com)  
 If you can't find the item you look for, please ask us in [consulta@egamaster.com](mailto:consulta@egamaster.com) or in [www.egamaster.com](http://www.egamaster.com)  
 Si vous ne trouvez pas l'article que vous desirez, consultez-nous a [consulta@egamaster.com](mailto:consulta@egamaster.com) ou a [www.egamaster.com](http://www.egamaster.com)

PCS.	Composición / Composition / Composition	Descripción / Description / Description	
1	65880		1/4"
2	65881, 65884	Adaptador para llaves de vaso / Adapter for socket wrenches	3/8"
	65882, 65885		1/2"
	62773		3/8"
1	62774	Adaptadores cuadrado - hexagono / Square - hex adapters	1/2"
	62775	Adaptadores portapuntas / Bit holders	
4	66261, 66262, 66263, 66264	Adaptadores portapuntas magnéticos / Magnetic bit holders	1/4"
1	65603	Agujas de trazar / Scribes	-
3	61442, 61444, 61445		1/4"
5	61447, 61450, 61459, 62118, 62732	Alargaderas / Extensions	3/8"
4	61453, 61455, 61458, 62119		1/2"
12	62331, 62333, 62337, 62338, 62339, 62340, 62341, 62342, 62343, 62345, 62348, 62349	Alicates / Pliers	
16	62180, 62181, 62182, 62183, 62214, 62215, 62216, 62218, 62219, 62220, 62222, 62223, 62224, 62226, 62227, 62228	Alicates Circlips / Circlips pliers	
2	62493, 62494	Alicates de terminales / Crimping pliers	-
9	62241, 62242, 62243, 62244, 62245, 62246, 62247, 62248, 62249	Alicates mini / Mini Pliers	
	62090	Alicates tipo Ford / Slip joint pliers	
	63745	Arcos de sierra / Hack saws	
	61435		1/4"
1	61436	Articulación universal / Universal joint	3/8"
	61437		1/2"
	61408		1/4"
	61409	Berbiquí / Speeder Handle	3/8"
	61434		1/2"
14	63387, 63388, 63389, 63390, 63391, 63392, 63393, 63408, 63409, 63410, 63411, 63412, 63413, 63414	Botadores / Punches	
6	62871, 62872, 62873, 62874, 62875, 62876	Buriles planos / Crosscut chisels	
1	66074	Buscapolos / Voltage tester	
18	62847, 62848, 62849, 62850, 62851, 62853, 62854, 62855, 62856, 62857, 63309, 63310, 63311, 63315, 63316, 63320, 63321, 63472	Cinceles / Chisels	-
2	65622, 65627	Compases / Calipers	
1	63915	Cortabridas / Plastic tie cutters	
	69501	Cortadores / Cutters	
3	63097, 63170, 63199	Cortatubos / Tube cutters	
1	66732	Destornillador portavasos / Socket holder	1/4"
4	57675, 57676, 57677, 57678	Destornilladores acodados / Offset screwdrivers	
3	55371, 66526, 66527	Destornilladores carroceros / Stubby screwdrivers	
15	55372, 55373, 55374, 55375, 55376, 55378, 55379, 55380, 55382, 55383, 55385, 55397, 55399, 55401, 66518	Destornilladores de vaso / Socket screwdrivers	
8	55352, 55354, 55355, 55357, 55358, 55359, 55360, 55361	Destornilladores electricista / Electrician screwdrivers	
11	55328, 55329, 55330, 55331, 55332, 55333, 55334, 55335, 55337, 55338, 55341	Destornilladores mecánicos / Slotted screwdrivers	
18	55449, 55450, 55451, 55452, 55453, 55457, 66850, 66851, 66852, 66853, 66854, 66866, 66867, 66868, 66869, 66870, 66871, 66872	Destornilladores Microtronic / Microtronic screwdrivers	
8	66437, 66438, 66439, 66440, 66441, 66442, 66443, 67192	Destornilladores Phillips® / Phillips® screwdriver	
3	66249, 66731, 66844	Destornilladores portapuntas / Bitholder screwdrivers	
8	66456, 66457, 66458, 66459, 66460, 66472, 66473, 67193	Destornilladores Pozidriv® / Pozidriv® screwdrivers	
3	66530, 66531, 66532	Destornilladores Robertson / Screwdrivers Robertson	
13	66487, 66488, 66489, 66490, 66491, 66492, 66493, 66494, 66495, 66496, 66497, 66498, 66499	Destornilladores Tamper Torx / Screwdrivers Tamper Torx	
1	63085	Escariadores / Reamers	
2	63701, 63709	Escofinas / Rasps	-
1	65766	Escuadra magnética para soldadura / Magnetic welding square	
2	65768, 65813	Escuadras / Squares	
8	61583, 61584, 61585, 61586, 61587, 61588, 61589, 61590	Extractores de tornillos / Screw extractors	
1	65361	Flexómetros / Measuring tapes	
6	63429, 63430, 63431, 63432, 63433, 63434	Granetes / Center punches	
1	65852	Juegos de golpe números / Punches numbers	
17	63492, 63504, 63528, 63540, 63564, 63576, 63600, 63612, 63636, 63648, 63672, 63684, 63714, 63715, 63717, 63718, 63719	Limas / Files	
1	58641	Linternas / Flashlights	
13	60380, 60381, 60382, 60384, 60385, 60388, 60390, 60391, 67886, 67887, 67888, 67893, 67894	Llaves acodadas / Double offset ring wrenches	
2	61110, 61113	Llaves ajustables / Adjustable wrenches	
	58460, 58461, 58462, 58463, 58464, 58465, 58466, 58467, 60340, 60341, 60342, 60343, 60344, 60345, 60346, 60347, 60348, 60349, 60350, 60351, 60352, 60353, 60354, 60355, 60356, 60358, 60957, 67878, 67885, 67953, 67954	Llaves combinadas / Combination wrenches	
1	62603	Llaves de carraca reversible / Reversible ratchet handles	1/4"

PCS.	Composición / Composition / Composition	Descripción / Description / Description	
1	62604	Llaves de carraca reversible / Reversible ratchet handles	3/8"
	62606		1/2"
10	68283, 68284, 68285, 68286, 68287, 68288, 68289, 68290, 68291, 68292	Llaves de gancho / Hook spanners	-
62	55813, 55814, 56015, 56017, 56018, 56019, 56020, 56021, 56023, 56024, 56025, 56026, 56027, 57165, 57166, 57167, 57168, 57169, 57170, 60420, 60421, 60422, 60423, 60424, 60425, 60426, 60427, 60428, 60429, 60430, 63989, 63990, 63991, 63992, 63993, 63994, 63995, 63996, 63997, 63998, 67674, 67675, 67676, 67677, 67678, 67679, 67680, 67681, 67682, 67683, 67684, 67689, 67690, 67691, 67692, 67693, 67694, 67695, 67696, 67697, 67698, 67699		1/4"
41	57173, 57174, 57175, 57176, 57177, 60439, 60440, 60441, 60442, 60443, 60444, 60445, 60446, 60447, 60448, 60449, 60450, 60451, 60452, 60453, 67620, 67621, 67622, 67623, 67624, 67625, 67626, 67627, 67750, 67751, 67752, 67753, 67754, 67755, 67756, 67757, 67758, 67759, 67760, 67761, 67762	Llaves de vaso / Socket wrenches	3/8"
85	55795, 55796, 55797, 55798, 55799, 55800, 55801, 55802, 55803, 55804, 55805, 55806, 55807, 55808, 55809, 55810, 55811, 55833, 55834, 57185, 57186, 57187, 60459, 60460, 60461, 60462, 60463, 60464, 60465, 60466, 60467, 60468, 60469, 60470, 60471, 60472, 60473, 60474, 60475, 60476, 60477, 60478, 60479, 60480, 60481, 60482, 60483, 60484, 60485, 60486, 60487, 60488, 60489, 60490, 60491, 60492, 60493, 60494, 60495, 60496, 60497, 60498, 65064, 65065, 65066, 65067, 65068, 65069, 65070, 65071, 65072, 65073, 67805, 67806, 67807, 67808, 67809, 67810, 67811, 67812, 67813, 67814, 67815, 67816, 67818		1/2"
6	56230, 56231, 56232, 56233, 56234, 58911	Llaves estrella dos bocas extrafina compensadas a 15° / Slim double ring wrenches 15° bent	
5	56235, 56236, 56237, 56238, 56239	Llaves estrella plana de dos bocas extrafinas / Slim flat double ring wrenches	
	57775, 57776, 57777, 57778, 57779	Llaves estrella planas / Double ended flat ring spanners	-
6	57718, 57719, 57720, 57721, 57722, 57723	Llaves estrella planas Torx / Double ended flat ring spanners Torx	
25	60300, 60301, 60302, 60303, 60304, 60305, 60306, 60307, 60308, 60309, 60310, 60311, 60312, 60313, 60314, 60315, 67931, 67934, 67939, 67940, 67941, 67942, 67943, 67944, 67945	Llaves fijas / Open-end wrenches	
5	57218, 57219, 57220, 57221, 57222	Llaves fijas Crowfoot / Open end Crowfoot wrenches	1/4"
11	55724, 55725, 55726, 55727, 55728, 55729, 55730, 55731, 55732, 55733, 55734		3/8"
8	56210, 56211, 56212, 56213, 56214, 56215, 56216, 56217	Llaves fijas extrafinas / Slim open end wrenches	
13	58537, 58538, 58539, 58540, 58541, 58542, 58543, 58544, 58545, 58546, 58547, 58548, 58549	Llaves fijas micromecánicas a 15° y 75° / 15° and 75° micromech open end wrenches	
31	65315, 65316, 65317, 65318, 65319, 65320, 65321, 65322, 65323, 65324, 65325, 65326, 65327, 65328, 65329, 67653, 67671, 67672, 68900, 68901, 68902, 68903, 68904, 68905, 68906, 68907, 68908, 68909, 68910, 68911, 68912	Llaves hexagonales / Hexagonal key wrenches	
13	68914, 68915, 68916, 68917, 68918, 68919, 68920, 68921, 68922, 68923, 68924, 68925, 68926	Llaves hexagonales bola / Hexagonal key wrenches ball type	
6	57148, 57149, 57150, 57151, 57152, 57153	Llaves media luna / Half moon spanners	-
8	58752, 58753, 58754, 58755, 58756, 58757, 58758, 58759	Llaves para racores / Flare nut spanners	
6	65975, 65976, 65977, 65978, 65979, 65980	Llaves Ribe® / Ribe® wrenches	
2	61001, 61004	Llaves Stillson / Stillson pipe wrenches	
20	56544, 56545, 56546, 56547, 56548, 56549, 56550, 56551, 56552, 56553, 56554, 56556, 56557, 56558, 56559, 56560, 56561, 56562, 56563, 56564	Llaves Tamper Torx / Tamper Torx keys	
	69504	Magnetizador-desmagnetizador / Magnetizer-demagnetizer	
	61438		1/4"
	61439	Mango correrizo en T / Sliding "T" handle	3/8"
1	61440		1/2"
	65874	Mango articulado / Swivel handle	1/4"
	65875		3/8"
14	55326, 69521, 69601, 69603, 69605, 69612, 69614, 69617, 69618, 69620, 69675, 69681, 69701, 69712	Martillos / Hammers	
5	68043, 68048, 68050, 68051, 68056	Muelles curvabutos / Spring tube benders	
1	69525	Navajas / Penknives	-
	65158	Nivel magnético torpedo / Torpedo Magnetic level	
4	69530, 69531, 69532, 69533	Pinzas / Tweezers	
	55265	Punta portavasos / Socket holder bit	1/4"
1	61695		
	61696	Puntas adaptadoras para vasos / Adapter bits for sockets	3/8"
	61697		1/2"
73	58157, 58158, 58160, 58161, 58164, 58180, 58181, 58182, 58183, 58184, 58185, 58186, 58187, 58188, 58227, 58228, 58229, 58230, 58231, 58232, 58233, 58234, 58235, 58236, 58237, 58238, 58239, 58240, 58241, 58242, 58243, 58244, 58245, 58246, 58247, 58248, 58249, 58250, 58251, 58252, 58253, 58254, 58255, 58256, 58257, 58258, 58259, 58260, 58261, 58262, 58263, 58264, 58265, 58266, 58267, 58268, 58269, 58273, 58274, 58275, 58276, 58277, 58278, 58279, 58280, 58281, 58282, 58288, 58289, 58290, 58291, 58292, 58293	Puntas atornilladoras / Bits	1/4"
64	53000, 53001, 53002, 53003, 53004, 53005, 53006, 53007, 53008, 53009, 53010, 53011, 53015, 53016, 53017, 53019, 53020, 53021, 53023, 53024, 53025, 53027, 53028, 53029, 53030, 53031, 53032, 53034, 53035, 53036, 53037, 53038, 53039, 53051, 53052, 53053, 53054, 53055, 53056, 53057, 53058, 53059, 53060, 55670, 55671, 55672, 55673, 55674, 55675, 55676, 55677, 55678, 55679, 58900, 66733, 66734, 66735, 66736, 66737, 66738, 66739, 66740, 66741, 66742	Puntas atornilladoras con vaso / Socket bits	



PCS.	Composición / Composition / Composition	Descripción / Description / Description	
65	53065, 53066, 53067, 53068, 53069, 53070, 53071, 53072, 53074, 53075, 53076, 53078, 53079, 53080, 53082, 53083, 53084, 53086, 53087, 53088, 53089, 53098, 53099, 53100, 53101, 53102, 53103, 55680, 55681, 55682, 55683, 55684, 55685, 55686, 55687, 56975, 56976, 56977, 56978, 56979, 56980, 56981, 56982, 56985, 56986, 56987, 56988, 56989, 56990, 56991, 56992, 56993, 58896, 58897, 66760, 66761, 66762, 66763, 66764, 66765, 66766, 66767, 66768, 66769, 66770	Puntas atornilladoras con vaso / Socket bits	3/8"
72	53105, 53107, 53108, 53109, 53110, 53115, 53116, 53117, 53118, 53119, 53120, 53121, 53122, 53123, 53124, 53125, 53127, 53128, 53129, 53131, 53132, 53133, 53134, 53136, 53137, 53138, 53139, 53149, 53150, 53151, 53152, 53153, 53154, 53155, 53156, 53157, 53158, 53159, 55688, 55689, 55690, 55691, 55692, 55693, 55695, 55696, 56896, 56897, 65985, 65986, 65987, 65988, 65989, 65990, 65991, 65992, 66801, 66802, 66803, 66804, 66805, 66806, 66820, 66821, 66822, 66823, 66824, 66825, 66826, 66827, 66828, 66829	Puntas atornilladoras con vaso / Socket bits	1/2"
1	65783	Punzón / Awl	
1	65601	Recogedor telescópico / Telescopic joint pick up	
10	64671, 64672, 64673, 64674, 64675, 64676, 64677, 64678, 64679, 64680	Reglas / Rulers	
2	69570, 69572	Sacabocados / Hollow punches	
6	62123, 62145, 62177, 62284, 62793, 62795	Sargentos / Clamps	
	62170	Tenazas / Pincers	
	69534	Tijeras / Tin snips	
1	65846	Tijeras electricista / Electrician's scissors	
	87628	Vaso adaptador para puntas / Square drive bit retainer	1/4"
	63988	Limpiador multiusos / Multi-purpose cleaner	250 ml
		Cinta de señalización de seguridad / Safety hazard signs tape	-



# EGGA Master

## ART IN INNOVATION

■ ≈ 900 PCS.

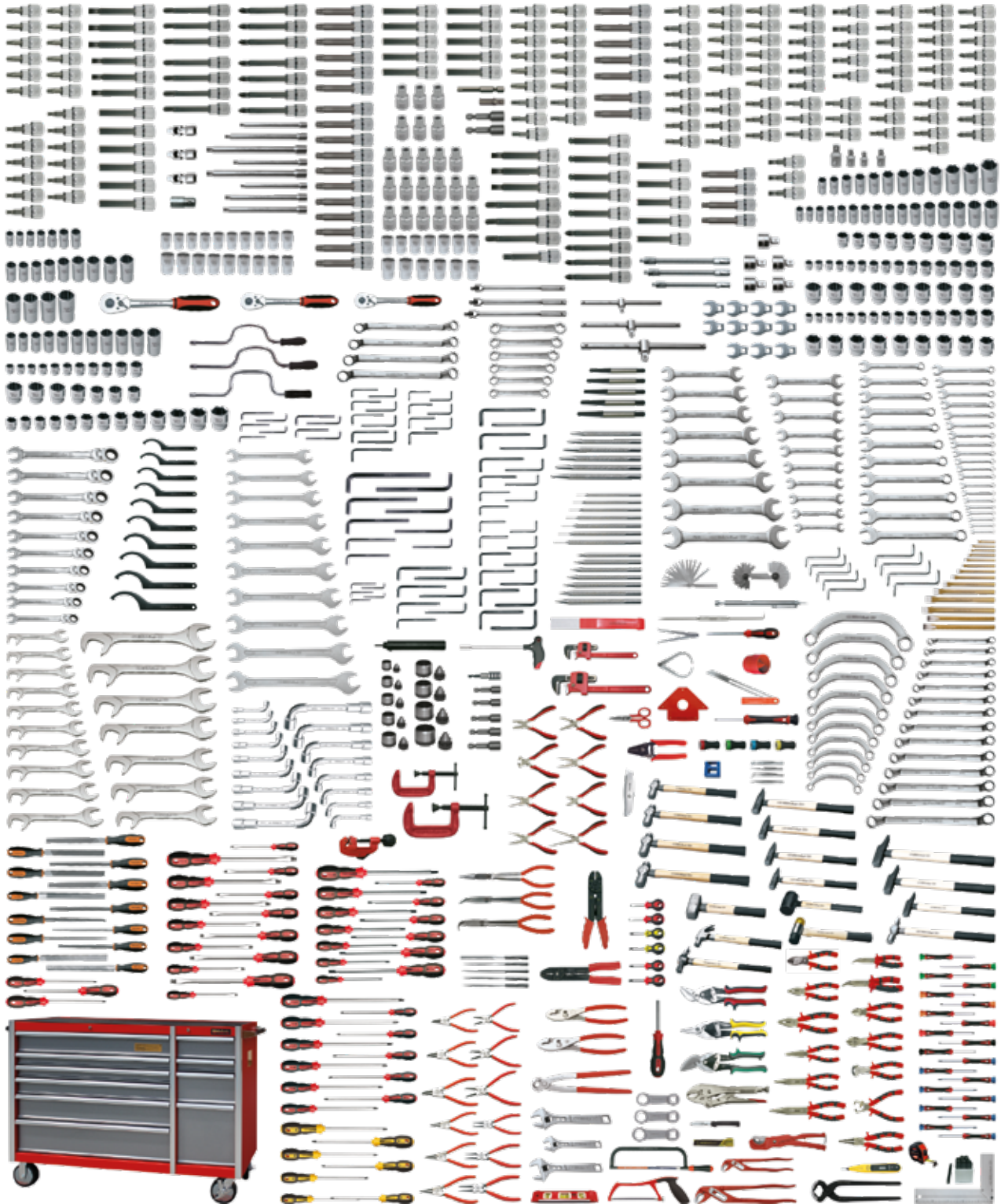
■ MM



COD.	PCS.		Medidas en / Sizes in / Mesures en	
51716				120
51717	895	57060	mm	310
51718		50954 (3)		380

Si no encuentra el artículo que necesita, consúltenos en [consulta@egamaster.com](mailto:consulta@egamaster.com) o en [www.egamaster.com](http://www.egamaster.com)  
 If you can't find the item you look for, please ask us in [consulta@egamaster.com](mailto:consulta@egamaster.com) or in [www.egamaster.com](http://www.egamaster.com)  
 Si vous ne trouvez pas l'article que vous desirez, consultez-nous a [consulta@egamaster.com](mailto:consulta@egamaster.com) ou a [www.egamaster.com](http://www.egamaster.com)

PCS.	Composición / Composition / Composition	Descripción / Description / Description	
1	65880		1/4"
2	65881, 65884	Adaptador para llaves de vaso / Adapter for socket wrenches	3/8"
	65882, 65885		1/2"
	62772		1/4"
1	62773	Adaptadores cuadrado - hexagono / Square - hex adapters	3/8"
	62774		1/2"
3	57315, 57316, 57317	Adaptadores de par / Torque adapters	3/8"
	62775	Adaptadores portapuntas / Bit holders	
1	66264	Adaptadores portapuntas magnéticos / Magnetic bit holders	1/4"
	65603	Agujas de trazar / Scribers	-
	61442, 61443, 61444, 61445		1/4"
4	61447, 61450, 62118, 62732	Alargaderas / Extensions	3/8"
	61453, 61455, 61458, 62119		1/2"
12	62331, 62333, 62337, 62338, 62339, 62340, 62341, 62342, 62343, 62344, 62346, 62349	Alicates / Pliers	
15	62180, 62181, 62182, 62183, 62215, 62216, 62219, 62220, 62223, 62224, 62227, 62228, 63954, 63955, 63956	Alicates Circlips / Circlips pliers	
2	62493, 62494	Alicates de terminales / Crimping pliers	-
9	62241, 62242, 62243, 62244, 62245, 62246, 62247, 62248, 62249	Alicates mini / Mini Pliers	
2	62090, 62092	Alicates tipo Ford / Slip joint pliers	
	63299, 63745	Arcos de sierra / Hack saws	
	61435		1/4"
	61436	Articulación universal / Universal joint	3/8"
1	61437		1/2"
	61408		1/4"
	61409	Berbiquí / Speeder Handle	3/8"
	61434		1/2"
14	63387, 63388, 63389, 63390, 63391, 63392, 63393, 63408, 63409, 63410, 63411, 63412, 63413, 63414	Botadores / Punches	
1	62876	Buriles planos / Crosscut chisels	
	66074	Buscapolos / Voltage tester	
14	62847, 62848, 62849, 62850, 62851, 62853, 62854, 62855, 62856, 62857, 62858, 63320, 63321, 63472	Cinceles / Chisels	-
2	65622, 65627	Compases / Calipers	
1	63915	Cortabridas / Plastic tie cutters	
	69501	Cortadores / Cutters	
2	63170, 63199	Cortatubos / Tube cutters	
1	66732	Destornillador portavasos / Socket holder	1/4"
9	57675, 57676, 57677, 57678, 57679, 57680, 57681, 57682, 57683	Destornilladores acodados / Offset screwdrivers	
4	66525, 66526, 66527, 66529	Destornilladores carroceros / Stubby screwdrivers	
11	66411, 66412, 66420, 66421, 66422, 66423, 66424, 66425, 66426, 66427, 66428	Destornilladores electricista / Electrician screwdrivers	
14	66399, 66400, 66401, 66402, 66403, 66404, 66405, 66406, 66407, 66408, 66409, 66410, 66448, 66449	Destornilladores mecánicos / Slotted screwdrivers	-
20	57684, 66846, 66847, 66848, 66849, 66850, 66851, 66852, 66853, 66854, 57685, 66864, 66865, 66866, 66867, 66868, 66869, 66870, 66871, 66872	Destornilladores Microtronic / Microtronic screwdrivers	
8	66437, 66438, 66439, 66440, 66441, 66442, 66443, 67192	Destornilladores Phillips® / Phillips® screwdriver	
1	66249	Destornilladores portapuntas / Bit holder screwdrivers	1/4"
8	66456, 66457, 66458, 66459, 66460, 66472, 66473, 67193	Destornilladores Pozidriv® / Pozidriv® screwdrivers	
3	66530, 66531, 66532	Destornilladores Robertson / Screwdrivers Robertson	
13	66487, 66488, 66489, 66490, 66491, 66492, 66493, 66494, 66495, 66496, 66497, 66498, 66499	Destornilladores Tamper Torx / Screwdrivers Tamper Torx	
1	63085	Escariadores / Reamers	
2	63701, 63709	Escofinas / Rasps	
1	65766	Escuadra magnética para soldadura / Magnetic welding square	
2	65768, 65813	Escuadras / Squares	
5	61586, 61587, 61588, 61589, 61590	Extractores de tornillos / Screw extractors	
1	65171	Flexómetros / Measuring tapes	-
2	65559, 65571	Galgas / Gauges	
6	63429, 63430, 63431, 63432, 63433, 63434	Granetes / Center punches	
1	65852	Juegos de golpe números / Punches numbers	
13	63504, 63540, 63576, 63612, 63648, 63672, 63684, 63692, 63714, 63715, 63717, 63718, 63719	Limas / Files	
1	58641	Linternas / Flashlights	
18	61774, 61775, 61776, 61777, 61778, 61779, 61780, 61781, 61782, 61783, 61784, 61785, 61786, 61787, 67843, 67844, 67845, 67855	Llaves acodadas / Double offset ring wrenches	
3	61109, 61112, 61213	Llaves ajustables / Adjustable wrenches	

PCS.	Composición / Composition / Composition	Descripción / Description / Description	
31	61725, 61726, 61727, 61728, 61729, 61730, 61731, 61732, 61733, 61734, 61735, 61736, 61737, 61738, 61739, 61740, 61741, 61742, 61743, 61744, 61745, 61746, 61747, 61748, 61749, 61750, 63965, 63966, 63967, 67880, 67881	Llaves combinadas / Combination wrenches	-
1	62603	Llaves de carraca reversible / Reversible ratchet handles	1/4"
	62604		3/8"
	62606		1/2"
10	68283, 68284, 68285, 68286, 68287, 68288, 68289, 68290, 68291, 68292	Llaves de gancho / Hook spanners	-
17	61870, 61871, 61872, 61873, 61874, 61875, 61876, 61877, 61878, 61879, 61880, 61881, 61882, 61883, 61884, 61885, 61886	Llaves de pipa / Angled sockets	-
41	55813, 55814, 56015, 56017, 56018, 56019, 56020, 56021, 56023, 56024, 56025, 56026, 56027, 57165, 57166, 57167, 57168, 57169, 57170, 63977, 63978, 63979, 63980, 63981, 63982, 63983, 63984, 63985, 63986, 63987, 67660, 67661, 67662, 67663, 67664, 67665, 67666, 67667, 67668, 67669, 67670		1/4"
43	57171, 57172, 57173, 57174, 57175, 57176, 57177, 57178, 61343, 61344, 61345, 61346, 61347, 61348, 61349, 61350, 61351, 61352, 61353, 61354, 61355, 61356, 61357, 67539, 67540, 67560, 67561, 67725, 67726, 67727, 67728, 67729, 67730, 67731, 67732, 67733, 67734, 67735, 67736, 67737, 67738, 67739, 67740	Llaves de vaso / Socket wrenches	3/8"
72	55795, 55796, 55797, 55798, 55799, 55800, 55801, 55802, 55803, 55804, 55805, 55806, 55807, 55808, 55809, 55810, 55811, 55833, 55834, 57179, 57180, 57181, 57182, 57183, 57184, 57185, 57186, 57187, 61380, 61381, 61382, 61383, 61384, 61385, 61386, 61387, 61388, 61389, 61390, 61391, 61392, 61393, 61394, 61395, 61396, 61397, 61398, 61399, 61400, 61401, 61402, 61403, 67780, 67781, 67782, 67783, 67784, 67785, 67786, 67787, 67788, 67789, 67791, 67792, 67793, 67794, 67795, 67796, 67797, 67798, 67799, 67800		1/2"
6	57718, 57719, 57720, 57721, 57722, 57723	Llaves estrella planas Torx / Double ended flat ring spanners Torx	-
16	61701, 61702, 61703, 61704, 61705, 61706, 61707, 61708, 61709, 61710, 61711, 61712, 61713, 67917, 67963, 67967	Llaves fijas / Open-end wrenches	-
3	57211, 57212, 57213		1/4"
8	55710, 55711, 55712, 55713, 55714, 55715, 55716, 55717	Llaves fijas Crowfoot / Open end Crowfoot wrenches	3/8"
10	56200, 56201, 56202, 56203, 56204, 56205, 56206, 56207, 56208, 56209	Llaves fijas extrafinas / Slim open end wrenches	-
17	58520, 58521, 58522, 58523, 58524, 58525, 58526, 58527, 58528, 58529, 58530, 58531, 58532, 58533, 58534, 58535, 58536	Llaves fijas micromecánicas a 15° y 75° / 15° and 75° micromech open end wrenches	-
30	61525, 61526, 61621, 61622, 61623, 61624, 65306, 65307, 65308, 65309, 65310, 65311, 65312, 65313, 65330, 65331, 65332, 65519, 65958, 65959, 65960, 67300, 67301, 67302, 67303, 67304, 67305, 67493, 67494, 67495	Llaves hexagonales / Hexagonal key wrenches	-
10	61530, 61531, 61532, 61533, 61534, 61535, 61536, 61537, 61538, 61539	Llaves mastergear articuladas / Mastergear joint wrenches	-
11	57155, 57156, 57157, 57158, 57159, 57160, 57161, 57162, 57163, 60795, 60798	Llaves media luna / Half moon spanners	-
2	61001, 61004	Llaves Stillson / Stillson pipe wrenches	-
20	56544, 56545, 56546, 56547, 56548, 56549, 56550, 56551, 56552, 56553, 56554, 56556, 56557, 56558, 56559, 56560, 56561, 56562, 56563, 56564	Llaves Tamper Torx / Tamper Torx keys	-
17	65333, 65334, 65335, 65336, 65337, 65338, 65339, 65340, 65341, 65342, 65343, 65344, 65346, 65347, 65348, 65349, 65350	Llaves Torx / Torx keys	-
	69504	Magnetizador-desmagnetizador / Magnetizer-demagnetizer	-
	65874		1/4"
	65875	Mango articulado / Swivel handle	3/8"
1	61441		1/2"
	61438		1/4"
	61439	Mango correzido en T / Sliding "T" handle	3/8"
	61440		1/2"
17	55326, 69521, 69601, 69603, 69605, 69610, 69612, 69613, 69614, 69617, 69618, 69620, 69622, 69675, 69681, 69701, 69712	Martillos / Hammers / Marteaux	-
1	69525	Navajas / Penknives	-
	65158	Nivel magnético torpedo / Torpedo Magnetic level	-
4	69530, 69531, 69532, 69533	Pinzas / Tweezers	-
	66049, 66052, 66053, 66054	Portatornillos magnéticos / Magnetic screwholders	-
1	55265	Punta portavasos / Socket holder bit	-
	58162	Puntas atornilladoras / Bits	-
61	53000, 53001, 53002, 53003, 53004, 53005, 53006, 53007, 53008, 53009, 53010, 53011, 53013, 53015, 53016, 53017, 53019, 53020, 53021, 53023, 53024, 53025, 53034, 53035, 53036, 53037, 53038, 53039, 53041, 53042, 53043, 53044, 53045, 53046, 53047, 53048, 53049, 53050, 55697, 55698, 55699, 55700, 58900, 66729, 66730, 66733, 66734, 66735, 66736, 66737, 66738, 66739, 66740, 66741, 66742, 66743, 66744, 66745, 66746, 66747, 67164	Puntas atornilladoras con vaso / Socket bits	1/4"
63	53063, 53065, 53066, 53067, 53068, 53069, 53070, 53071, 53072, 53074, 53075, 53076, 53078, 53079, 53080, 53082, 53083, 53084, 53086, 53087, 53088, 53089, 53098, 53099, 53100, 53101, 53102, 53103, 55701, 55702, 55703, 58892, 58893, 58896, 58897, 66760, 66761, 66762, 66763, 66764, 66765, 66766, 66767, 66768, 66769, 66770, 66771, 66772, 66773, 66774, 66775, 66776, 66777, 66778, 66779, 66780, 66781, 66782, 66783, 66784, 66785, 66786, 66787		3/8"





PCS.	Composición / Composition / Composition	Descripción / Description / Description	
78	53105, 53107, 53108, 53109, 53110, 53115, 53116, 53117, 53118, 53119, 53120, 53121, 53122, 53123, 53124, 53125, 53127, 53128, 53129, 53131, 53132, 53133, 53134, 53136, 53137, 53138, 53139, 53149, 53150, 53151, 53152, 53153, 53154, 53155, 53156, 53157, 53158, 53159, 55704, 55705, 55706, 55707, 55708, 56895, 56896, 56897, 66801, 66802, 66803, 66804, 66805, 66806, 66807, 66808, 66809, 66810, 66811, 66812, 66813, 66814, 66815, 66816, 66817, 66818, 66819, 66820, 66821, 66822, 66823, 66824, 66825, 66826, 66827, 66828, 66829, 66842, 67213, 67214	Puntas atornilladoras con vaso / Socket bits	1/2"
7	57575, 57576, 66269, 66270, 66271, 66279, 66280	Puntas Stecker / Magnetic Stecker	1/4"
1	65783	Punzón / Awl	
	65601	Recogedor telescópico / Telescopic joint pick up	
10	64671, 64672, 64673, 64674, 64675, 64676, 64677, 64678, 64679, 64680	Sacabocados / Hollow punches	
2	69570, 69572	Sargentos / Clamps	-
6	62123, 62146, 62177, 62284, 62793, 62795	Tenazas / Pincers	
3	62169, 62170, 62171	Tijeras / Tin snips	
	69534	Tijeras electricista / Electrician's scissors	
1	65846	Vaso adaptador para puntas / Square drive bit retainer	1/4"
	87628	Limpiador multiusos / Multi-purpose cleaner	250 ml
	63988	Cinta de señalización de seguridad / Safety hazard signs tape	-

# EGGA Master

## ART IN INNOVATION

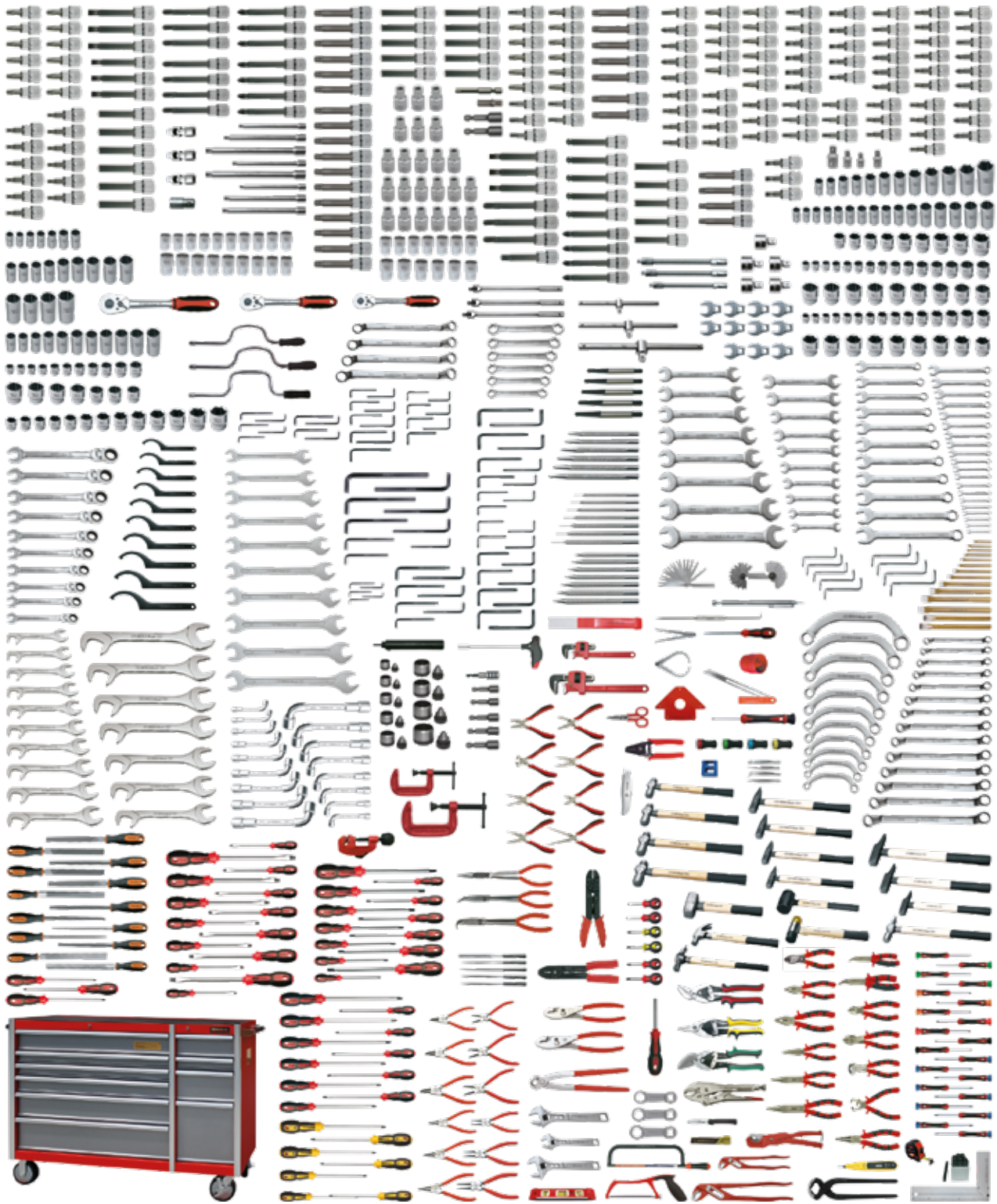
INCH



COD.	PCS.		Medidas en / Sizes in / Mesures en	
51680				120
51681	894	57060	inch	310
51682		50954 (3)		380

PCS.	Composición / Composition / Composition	Descripción / Description / Description	
1	65880		1/4"
2	65881, 65884	Adaptador para llaves de vaso / Adapter for socket wrenches	3/8"
	65882, 65885		1/2"
	62773		3/8"
1	62774	Adaptadores cuadrado - hexagono / Square - hex adapters	1/2"
	62775	Adaptadores portapuntas / Bit holders	
4	66261, 66262, 66263, 66264	Adaptadores portapuntas magnéticos / Magnetic bit holders	1/4"
1	65603	Agujas de trazar / Scribes	-
3	61442, 61444, 61445		1/4"
5	61447, 61450, 61459, 62118, 62732	Alargaderas / Extensions	3/8"
4	61453, 61455, 61458, 62119		1/2"
13	62331, 62333, 62337, 62338, 62339, 62340, 62341, 62342, 62343, 62345, 62348, 62349, 62370	Alicates / Pliers	
16	62180, 62181, 62182, 62183, 62214, 62215, 62216, 62218, 62219, 62220, 62222, 62223, 62224, 62226, 62227, 62228	Alicates Circlips / Circlips pliers	
2	62493, 62494	Alicates de terminales / Crimping pliers	-
9	62241, 62242, 62243, 62244, 62245, 62246, 62247, 62248, 62249	Alicates mini / Mini Pliers	
2	62090, 62092	Alicates tipo Ford / Slip joint pliers	
	63745	Arcos de sierra / Hack saws	
	61435		1/4"
	61436	Articulación universal / Universal joint	3/8"
1	61437		1/2"
	61408		1/4"
	61409	Berbiquí / Speeder Handle	3/8"
	61434		1/2"
14	63387, 63388, 63389, 63390, 63391, 63392, 63393, 63408, 63409, 63410, 63411, 63412, 63413, 63414	Botadores / Punches	
6	62871, 62872, 62873, 62874, 62875, 62876	Buriles planos / Crosscut chisels	
1	66074	Buscapolos / Voltage tester	
19	62847, 62848, 62849, 62850, 62851, 62853, 62854, 62855, 62856, 62857, 62858, 63309, 63310, 63311, 63315, 63316, 63320, 63321, 63472	Cinceles / Chisels	-
2	65622, 65627	Compases / Calipers	
1	63915	Cortabridas / Plastic tie cutters	
	69501	Cortadores / Cutters	
3	63097, 63170, 63199	Cortatubos / Tube cutters	
1	66732	Destornillador portavasos / Socket holder	1/4"
4	57675, 57676, 57677, 57678	Destornilladores acodados / Offset screwdrivers	
3	55371, 66526, 66527	Destornilladores carroceros / Stubby screwdrivers	
15	55372, 55373, 55374, 55375, 55376, 55378, 55379, 55380, 55382, 55383, 55385, 55397, 55399, 55401, 66518	Destornilladores de vaso / Socket screwdrivers	
8	55352, 55354, 55355, 55357, 55358, 55359, 55360, 55361	Destornilladores electricista / Electrician screwdrivers	
11	55328, 55329, 55330, 55331, 55332, 55333, 55334, 55335, 55337, 55338, 55341	Destornilladores mecánicos / Slotted screwdrivers	
18	55449, 55450, 55451, 55452, 55453, 55457, 66850, 66851, 66852, 66853, 66854, 66866, 66867, 66868, 66869, 66870, 66871, 66872	Destornilladores Microtronic / Microtronic screwdrivers	
8	66437, 66438, 66439, 66440, 66441, 66442, 66443, 67192	Destornilladores Phillips® / Phillips® screwdriver	
4	66249, 66731, 66843, 66844	Destornilladores portapuntas / Bitholder screwdrivers	
8	66456, 66457, 66458, 66459, 66460, 66472, 66473, 67193	Destornilladores Pozidriv® / Pozidriv® screwdrivers	
3	66530, 66531, 66532	Destornilladores Robertson / Screwdrivers Robertson	
13	66487, 66488, 66489, 66490, 66491, 66492, 66493, 66494, 66495, 66496, 66497, 66498, 66499	Destornilladores Tamper Torx / Screwdrivers Tamper Torx	
1	63085	Escariadores / Reamers	
2	63701, 63709	Escofinas / Rasps	-
1	65766	Escuadra magnética para soldadura / Magnetic welding square	
2	65768, 65813	Escuadras / Squares	
8	61583, 61584, 61585, 61586, 61587, 61588, 61589, 61590	Extractores de tornillos / Screw extractors	
1	65361	Flexómetros / Measuring tapes	
6	63429, 63430, 63431, 63432, 63433, 63434	Granetes / Center punches	
1	65852	Juegos de golpe números / Punches numbers	
17	63492, 63504, 63528, 63540, 63564, 63576, 63600, 63612, 63636, 63648, 63672, 63684, 63714, 63715, 63717, 63718, 63719	Limas / Files	
1	58641	Linternas / Flashlights	
13	60380, 60381, 60382, 60384, 60385, 60388, 60390, 60391, 67886, 67887, 67888, 67893, 67894	Llaves acodadas / Double offset ring wrenches	
3	61110, 61113, 61213	Llaves ajustables / Adjustable wrenches	
	58460, 58461, 58462, 58463, 58464, 58465, 58466, 58467, 60340, 60341, 60342, 60343, 60344, 60345, 60346, 60347, 60348, 60349, 60350, 60351, 60352, 60353, 60354, 60355, 60356, 60358, 60957, 67878, 67885, 67953, 67954	Llaves combinadas / Combination wrenches	
31			
1	62603	Llaves de carraca reversible / Reversible ratchet handles	1/4"



PCS.	Composición / Composition / Composition	Descripción / Description / Description	
1	62604	Llaves de carraca reversible / Reversible ratchet handles	3/8"
	62606		1/2"
10	68283, 68284, 68285, 68286, 68287, 68288, 68289, 68290, 68291, 68292	Llaves de gancho / Hook spanners	-
40	55813, 55814, 56015, 56017, 56018, 56019, 56020, 56021, 56023, 56024, 56025, 56026, 56027, 57165, 57166, 57167, 57168, 57169, 57170, 63989, 63990, 63991, 63992, 63993, 63994, 63995, 63996, 63997, 63998, 67689, 67690, 67691, 67692, 67693, 67694, 67695, 67696, 67697, 67698, 67699		1/4"
33	57173, 57174, 57175, 57176, 57177, 60439, 60440, 60441, 60442, 60443, 60444, 60445, 60446, 60447, 60448, 60449, 60450, 60451, 60452, 60453, 67750, 67751, 67752, 67753, 67754, 67755, 67756, 67757, 67758, 67759, 67760, 67761, 67762	Llaves de vaso / Socket wrenches	3/8"
55	55795, 55796, 55797, 55798, 55799, 55800, 55801, 55802, 55803, 55804, 55805, 55806, 55807, 55808, 55809, 55810, 55811, 55833, 55834, 57185, 57186, 57187, 60479, 60480, 60481, 60482, 60483, 60484, 60485, 60486, 60487, 60488, 60489, 60490, 60491, 60492, 60493, 60494, 60495, 60496, 60497, 60498, 67805, 67806, 67807, 67808, 67809, 67810, 67811, 67812, 67813, 67814, 67815, 67816, 67818		1/2"
6	56230, 56231, 56232, 56233, 56234, 58911	Llaves estrella dos bocas extrafina compensadas a 15° / Slim double ring wrenches 15° bent	
5	56235, 56236, 56237, 56238, 56239	Llaves estrella plana de dos bocas extrafinas / Slim flat double ring wrenches	
	57775, 57776, 57777, 57778, 57779	Llaves estrella planas / Double ended flat ring spanners	-
6	57718, 57719, 57720, 57721, 57722, 57723	Llaves estrella planas Torx / Double ended flat ring spanners Torx	
25	60300, 60301, 60302, 60303, 60304, 60305, 60306, 60307, 60308, 60309, 60310, 60311, 60312, 60313, 60314, 60315, 67931, 67934, 67939, 67940, 67941, 67942, 67943, 67944, 67945	Llaves fijas / Open-end wrenches	
5	57218, 57219, 57220, 57221, 57222	Llaves fijas Crowfoot / Open end Crowfoot wrenches	1/4"
11	55724, 55725, 55726, 55727, 55728, 55729, 55730, 55731, 55732, 55733, 55734		3/8"
8	56210, 56211, 56212, 56213, 56214, 56215, 56216, 56217	Llaves fijas extrafinas / Slim open end wrenches	-
11	55750, 55751, 55752, 55753, 55754, 55755, 55756, 55757, 55758, 55759, 55760	Llaves fijas hexagonales Crow Foot / Hexagonal Crow Foot wrenches	3/8"
13	58537, 58538, 58539, 58540, 58541, 58542, 58543, 58544, 58545, 58546, 58547, 58548, 58549	Llaves fijas micromecánicas a 15° y 75° / 15° and 75° micromech open end wrenches	
32	65315, 65316, 65317, 65318, 65319, 65320, 65321, 65322, 65323, 65324, 65325, 65326, 65327, 65328, 65329, 67614, 67653, 67671, 67672, 68900, 68901, 68902, 68903, 68904, 68905, 68906, 68907, 68908, 68909, 68910, 68911, 68912	Llaves hexagonales / Hexagonal key wrenches	
13	68914, 68915, 68916, 68917, 68918, 68919, 68920, 68921, 68922, 68923, 68924, 68925, 68926	Llaves hexagonales bola / Hexagonal key wrenches ball type	
6	57148, 57149, 57150, 57151, 57152, 57153	Llaves media luna / Half moon spanners	
9	58752, 58753, 58754, 58755, 58756, 58757, 58758, 58759, 58760	Llaves para racores / Flare nut spanners	-
6	65975, 65976, 65977, 65978, 65979, 65980	Llaves Ribe® / Ribe® wrenches	
2	61001, 61004	Llaves Stillson / Stillson pipe wrenches	
20	56544, 56545, 56546, 56547, 56548, 56549, 56550, 56551, 56552, 56553, 56554, 56556, 56557, 56558, 56559, 56560, 56561, 56562, 56563, 56564	Llaves Tamper Torx / Tamper Torx keys	
	69504	Magnetizador-desmagnetizador / Magnetizer-demagnetizer	
	65874		1/4"
	65875	Mango articulado / Swivel handle	3/8"
1	61441		1/2"
	61438		1/4"
	61439	Mango corredizo en T / Sliding "T" handle	3/8"
	61440		1/2"
15	55326, 69521, 69601, 69603, 69605, 69610, 69612, 69614, 69617, 69618, 69620, 69675, 69681, 69701, 69712	Martillos / Hammers	
5	68043, 68048, 68050, 68051, 68056	Muelles curvabutos / Spring tube benders	
1	69525	Navajas / Penknives	-
	65158	Nivel magnético torpedo / Torpedo Magnetic level	
4	69530, 69531, 69532, 69533	Pinzas / Tweezers	
	55265	Punta portavasos / Socket holder bit	1/4"
1	61695		3/8"
	61696	Puntas adaptadoras para vasos / Adapter bits for sockets	3/8"
	61697		1/2"
64	53000, 53001, 53002, 53003, 53004, 53005, 53006, 53007, 53008, 53009, 53010, 53011, 53015, 53016, 53017, 53019, 53020, 53021, 53023, 53024, 53025, 53027, 53028, 53029, 53030, 53031, 53032, 53034, 53035, 53036, 53037, 53038, 53039, 53051, 53052, 53053, 53054, 53055, 53056, 53057, 53058, 53059, 53060, 55670, 55671, 55672, 55673, 55674, 55675, 55676, 55677, 55678, 55679, 58900, 66733, 66734, 66735, 66736, 66737, 66738, 66739, 66740, 66741, 66742		1/4"
65	53065, 53066, 53067, 53068, 53069, 53070, 53071, 53072, 53074, 53075, 53076, 53078, 53079, 53080, 53082, 53083, 53084, 53086, 53087, 53088, 53089, 53098, 53099, 53100, 53101, 53102, 53103, 55680, 55681, 55682, 55683, 55684, 55685, 55686, 55687, 56975, 56976, 56977, 56978, 56979, 56980, 56981, 56982, 56985, 56986, 56987, 56988, 56989, 56990, 56991, 56992, 56993, 58896, 58897, 66760, 66761, 66762, 66763, 66764, 66765, 66766, 66767, 66768, 66769, 66770	Puntas atornilladoras con vaso / Socket bits	3/8"
72	53105, 53107, 53108, 53109, 53110, 53115, 53116, 53117, 53118, 53119, 53120, 53121, 53122, 53123, 53124, 53125, 53127, 53128, 53129, 53131, 53132, 53133, 53134, 53136, 53137, 53138, 53139, 53149, 53150, 53151, 53152, 53153, 53154, 53155, 53156, 53157, 53158, 53159, 55688, 55689, 55690, 55691, 55692, 55693, 55695, 55696, 56896, 56897, 65985, 65986, 65987, 65988, 65989, 65990, 65991, 65992, 66801, 66802, 66803, 66804, 66805, 66806, 66820, 66821, 66822, 66823, 66824, 66825, 66826, 66827, 66828, 66829		1/2"

PCS.	Composición / Composition / Composition	Descripción / Description / Description	
	65783	Punzón / Awl	
1	65601	Recogedor telescópico / Telescopic joint pick up	
	65831	Reglas / Rulers	
10	64671, 64672, 64673, 64674, 64675, 64676, 64677, 64678, 64679, 64680	Sacabocados / Hollow punches	
2	69570, 69572	Sargentos / Clamps	
8	62123, 62125, 62145, 62146, 62177, 62284, 62793, 62795	Tenazas / Pincers	
3	62169, 62170, 62171	Tijeras / Tin snips	
	69534	Tijeras electricista / Electrician's scissors	
1	65846	Vaso adaptador para puntas / Square drive bit retainer	1/4"
	87628	Limpiador multiusos / Multi-purpose cleaner	250 ml
	63988	Cinta de señalización de seguridad / Safety hazard signs tape	-

**EGGA** *Master*

---

ART IN INNOVATION

■ ≈ 800 PCS.

■ MM

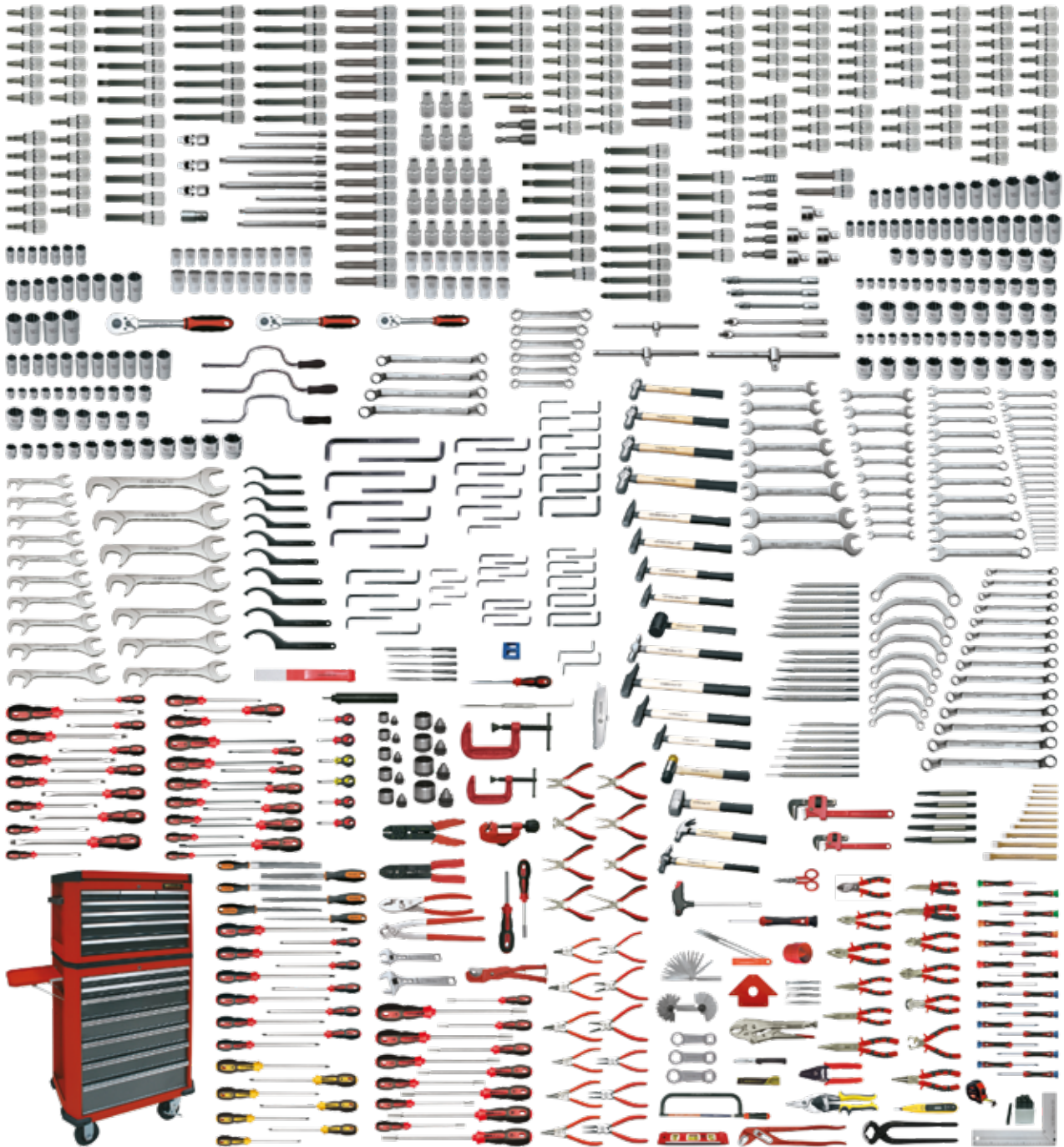

COD.	PCS.		Medidas en / Sizes in / Mesures en		
			mm		
51683		-			100
51684	802	51117	mm		230
51685		51074		●	360





PCS.	Composición / Composition / Composition	Descripción / Description / Description	
1	65880		1/4"
2	65881, 65884 65882, 65885	Adaptador para llaves de vaso / Adapter for socket wrenches	3/8"
3	57315, 57316, 57317	Adaptadores de par / Torque adapters	3/8"
1	66264	Adaptadores portapuntas magnéticos / Magnetic bit holders	1/4"
	65603	Agujas de trazar / Scribers	-
	61442, 61443, 61444, 61445		1/4"
4	61447, 61450, 62118, 62732	Alargaderas / Extensions	3/8"
	61453, 61455, 61458, 62119		1/2"
12	62331, 62333, 62337, 62338, 62339, 62340, 62341, 62342, 62343, 62344, 62346, 62349 62180, 62181, 62182, 62183, 62215, 62216, 62219, 62220, 62223, 62224, 62227, 62228	Alicates / Pliers Alicates Circlips / Circlips pliers	
2	62493, 62494	Alicates de terminales / Crimping pliers	
9	62241, 62242, 62243, 62244, 62245, 62246, 62247, 62248, 62249	Alicates mini / Mini Pliers	
	62092	Alicates tipo Ford / Slip joint pliers	
	63745	Arcos de sierra / Hack saws	
	61435		1/4"
1	61436	Articulación universal / Universal joint	3/8"
	61437		1/2"
	61408		1/4"
	61409	Berbiquí / Speeder Handle	3/8"
	61434		1/2"
14	63387, 63388, 63389, 63390, 63391, 63392, 63393, 63408, 63409, 63410, 63411, 63412, 63413, 63414	Botadores / Punches	
1	66074	Buscapolos / Voltage tester	
11	62847, 62848, 62849, 62850, 62853, 62854, 62855, 62856, 62857, 62858, 63472	Cinceles / Chisels	
1	63915	Cortabridas / Plastic tie cutters	
	69501	Cortadores / Cutters	
2	63170, 63199	Cortatubos / Tube cutters	
1	66732	Destornillador portavasos / Socket holder	1/4"
2	57681, 57682	Destornilladores acodados / Offset screwdrivers	
4	66525, 66526, 66527, 66529	Destornilladores carroceros / Stubby screwdrivers	
13	66509, 66510, 66511, 66512, 66513, 66514, 66515, 66516, 66517, 66518, 66519, 66520, 66521	Destornilladores de vaso / Socket screwdrivers	
11	66411, 66412, 66420, 66421, 66422, 66423, 66424, 66425, 66426, 66427, 66428	Destornilladores electricista / Electrician screwdrivers	
14	66399, 66400, 66401, 66402, 66403, 66404, 66405, 66406, 66407, 66408, 66409, 66410, 66448, 66449	Destornilladores mecánicos / Slotted screwdrivers	
20	57684, 66846, 66847, 66848, 66849, 66850, 66851, 66852, 66853, 66854, 57685, 66864, 66865, 66866, 66867, 66868, 66869, 66870, 66871, 66872	Destornilladores Microtronic / Microtronic screwdrivers	
8	66437, 66438, 66439, 66440, 66441, 66442, 66443, 67192	Destornilladores Phillips® / Phillips® screwdriver	
2	66249, 66731	Destornilladores portapuntas / Bitholder screwdrivers	
8	66456, 66457, 66458, 66459, 66460, 66472, 66473, 67193	Destornilladores Pozidriv® / Pozidriv® screwdrivers	
3	66530, 66531, 66532	Destornilladores Robertson / Screwdrivers Robertson	
13	66487, 66488, 66489, 66490, 66491, 66492, 66493, 66494, 66495, 66496, 66497, 66498, 66499	Destornilladores Tamper Torx / Screwdrivers Tamper Torx	
1	63085	Escariadores / Reamers	
	65766	Escuadra magnética para soldadura / Magnetic welding square	
2	65768, 65813	Escuadras / Squares	
5	61586, 61587, 61588, 61589, 61590	Extractores de tornillos / Screw extractors	
1	65171	Flexómetros / Measuring tapes	
2	65559, 65571	Galgas / Gauges	
6	63429, 63430, 63431, 63432, 63433, 63434	Granetes / Center punches	
1	65852	Juegos de golpe números / Punches numbers	
6	63692, 63714, 63715, 63717, 63718, 63719	Limas / Files	
1	58641	Linternas / Flashlights	
18	61774, 61775, 61776, 61777, 61778, 61779, 61780, 61781, 61782, 61783, 61784, 61785, 61786, 61787, 67843, 67844, 67845, 67855	Llaves acodadas / Double offset ring wrenches	
2	61112, 61213	Llaves ajustables / Adjustable wrenches	
31	61725, 61726, 61727, 61728, 61729, 61730, 61731, 61732, 61733, 61734, 61735, 61736, 61737, 61738, 61739, 61740, 61741, 61742, 61743, 61744, 61745, 61746, 61747, 61748, 61749, 61750, 63965, 63966, 63967, 67880, 67881	Llaves combinadas / Combination wrenches	
	62603		1/4"
1	62604	Llaves de carraca reversible / Reversible ratchet handles	3/8"
	62606		1/2"
10	68283, 68284, 68285, 68286, 68287, 68288, 68289, 68290, 68291, 68292	Llaves de gancho / Hook spanners	-
41	55813, 55814, 56015, 56017, 56018, 56019, 56020, 56021, 56023, 56024, 56025, 56026, 56027, 57165, 57166, 57167, 57168, 57169, 57170, 63977, 63978, 63979, 63980, 63981, 63982, 63983, 63984, 63985, 63986, 63987, 67660, 67661, 67662, 67663, 67664, 67665, 67666, 67667, 67668, 67669, 67670	Llaves de vaso / Socket wrenches	1/4"
43	57171, 57172, 57173, 57174, 57175, 57176, 57177, 57178, 61343, 61344, 61345, 61346, 61347, 61348, 61349, 61350, 61351, 61352, 61353, 61354, 61355, 61356, 61357, 67539, 67540, 67560, 67561, 67725, 67726, 67727, 67728, 67729, 67730, 67731, 67732, 67733, 67734, 67735, 67736, 67737, 67738, 67739, 67740		3/8"

PCS.	Composición / Composition / Composition	Descripción / Description / Description	
72	55795, 55796, 55797, 55798, 55799, 55800, 55801, 55802, 55803, 55804, 55805, 55806, 55807, 55808, 55809, 55810, 55811, 55833, 55834, 57179, 57180, 57181, 57182, 57183, 57184, 57185, 57186, 57187, 61380, 61381, 61382, 61383, 61384, 61385, 61386, 61387, 61388, 61389, 61390, 61391, 61392, 61393, 61394, 61395, 61396, 61397, 61398, 61399, 61400, 61401, 61402, 61403, 67780, 67781, 67782, 67783, 67784, 67785, 67786, 67787, 67788, 67789, 67791, 67792, 67793, 67794, 67795, 67796, 67797, 67798, 67799, 67800	Llaves de vaso / Socket wrenches	1/2"
6	57718, 57719, 57720, 57721, 57722, 57723	Llaves estrella planas Torx / Double ended flat ring spanners Torx	
16	61701, 61702, 61703, 61704, 61705, 61706, 61707, 61708, 61709, 61710, 61711, 61712, 61713, 67917, 67963, 67967	Llaves fijas / Open-end wrenches	
17	58520, 58521, 58522, 58523, 58524, 58525, 58526, 58527, 58528, 58529, 58530, 58531, 58532, 58533, 58534, 58535, 58536	Llaves fijas micromecánicas a 15° y 75° / 15° and 75° micromech open end wrenches	
37	61501, 61502, 61503, 61504, 61505, 61506, 61517, 61518, 61519, 61525, 61526, 61621, 61622, 61623, 61624, 65302, 65303, 65304, 65306, 65307, 65308, 65309, 65310, 65311, 65330, 65331, 65332, 65519, 65955, 65956, 65958, 65959, 67300, 67301, 67302, 67493, 67494	Llaves hexagonales / Hexagonal key wrenches	-
9	57155, 57156, 57157, 57158, 57159, 57160, 57161, 57162, 60795	Llaves media luna / Half moon spanners	
2	61001, 61004	Llaves Stillson / Stillson pipe wrenches	
20	56544, 56545, 56546, 56547, 56548, 56549, 56550, 56551, 56552, 56553, 56554, 56556, 56557, 56558, 56559, 56560, 56561, 56562, 56563, 56564	Llaves Tamper Torx / Tamper Torx keys	
	69504	Magnetizador-desmagnetizador / Magnetizer-demagnetizer	
	65874	Mango articulado / Swivel handle	1/4"
1	65875		3/8"
	61438		1/4"
	61439	Mango correrizo en T / Sliding "T" handle	3/8"
	61440		1/2"
17	55326, 69521, 69601, 69603, 69605, 69610, 69612, 69613, 69614, 69617, 69618, 69620, 69622, 69675, 69681, 69701, 69712	Martillos / Hammers	
1	69525	Navajas / Penknives	-
	65158	Nivel magnético torpedo / Torpedo Magnetic level	
4	69530, 69531, 69532, 69533	Pinzas / Tweezers	
1	55265	Punta portavasos / Socket holder bit	
59	53000, 53001, 53002, 53003, 53004, 53005, 53006, 53007, 53008, 53009, 53010, 53011, 53013, 53015, 53016, 53017, 53019, 53020, 53021, 53023, 53024, 53025, 53034, 53035, 53036, 53037, 53038, 53039, 53041, 53042, 53043, 53044, 53045, 53046, 53047, 53048, 53049, 53050, 55697, 55698, 55699, 55700, 58900, 66733, 66734, 66735, 66736, 66737, 66738, 66739, 66740, 66741, 66742, 66743, 66744, 66745, 66746, 66747, 67164		1/4"
60	53065, 53066, 53067, 53068, 53069, 53070, 53071, 53072, 53074, 53075, 53076, 53078, 53079, 53080, 53082, 53083, 53084, 53086, 53087, 53088, 53089, 53098, 53099, 53100, 53101, 53102, 53103, 55701, 55702, 55703, 58896, 58897, 66760, 66761, 66762, 66763, 66764, 66765, 66766, 66767, 66768, 66769, 66770, 66771, 66772, 66773, 66774, 66775, 66776, 66777, 66778, 66779, 66780, 66781, 66782, 66783, 66784, 66785, 66786, 66787	Puntas atornilladoras con vaso / Socket bits	3/8"
77	53105, 53107, 53108, 53109, 53110, 53115, 53116, 53117, 53118, 53119, 53120, 53121, 53122, 53123, 53124, 53125, 53127, 53128, 53129, 53131, 53132, 53133, 53134, 53136, 53137, 53138, 53139, 53149, 53150, 53151, 53152, 53153, 53154, 53155, 53156, 53157, 53158, 53159, 55704, 55705, 55706, 55707, 55708, 56896, 56897, 66801, 66802, 66803, 66804, 66805, 66806, 66807, 66808, 66809, 66810, 66811, 66812, 66813, 66814, 66815, 66816, 66817, 66818, 66819, 66820, 66821, 66822, 66823, 66824, 66825, 66826, 66827, 66828, 66829, 66842, 67213, 67214		1/2"
8	57575, 57576, 66269, 66270, 66271, 66279, 66280, 66357	Puntas Stecker / Magnetic Stecker	1/4"
1	65783	Punzón / Awl	
10	64671, 64672, 64673, 64674, 64675, 64676, 64677, 64678, 64679, 64680	Sacabocados / Hollow punches	
2	69570, 69572	Sargentos / Clamps	
5	62123, 62146, 62177, 62284, 62795	Tenazas / Pincers	
	62170	Tijeras / Tin snips	
	69534	Tijeras electricista / Electrician's scissors	
1	65846	Vaso adaptador para puntas / Square drive bit retainer	1/4"
	87628	Limpiador multiusos / Multi-purpose cleaner	250 ml
	63988	Cinta de señalización de seguridad / Safety hazard signs tape	-

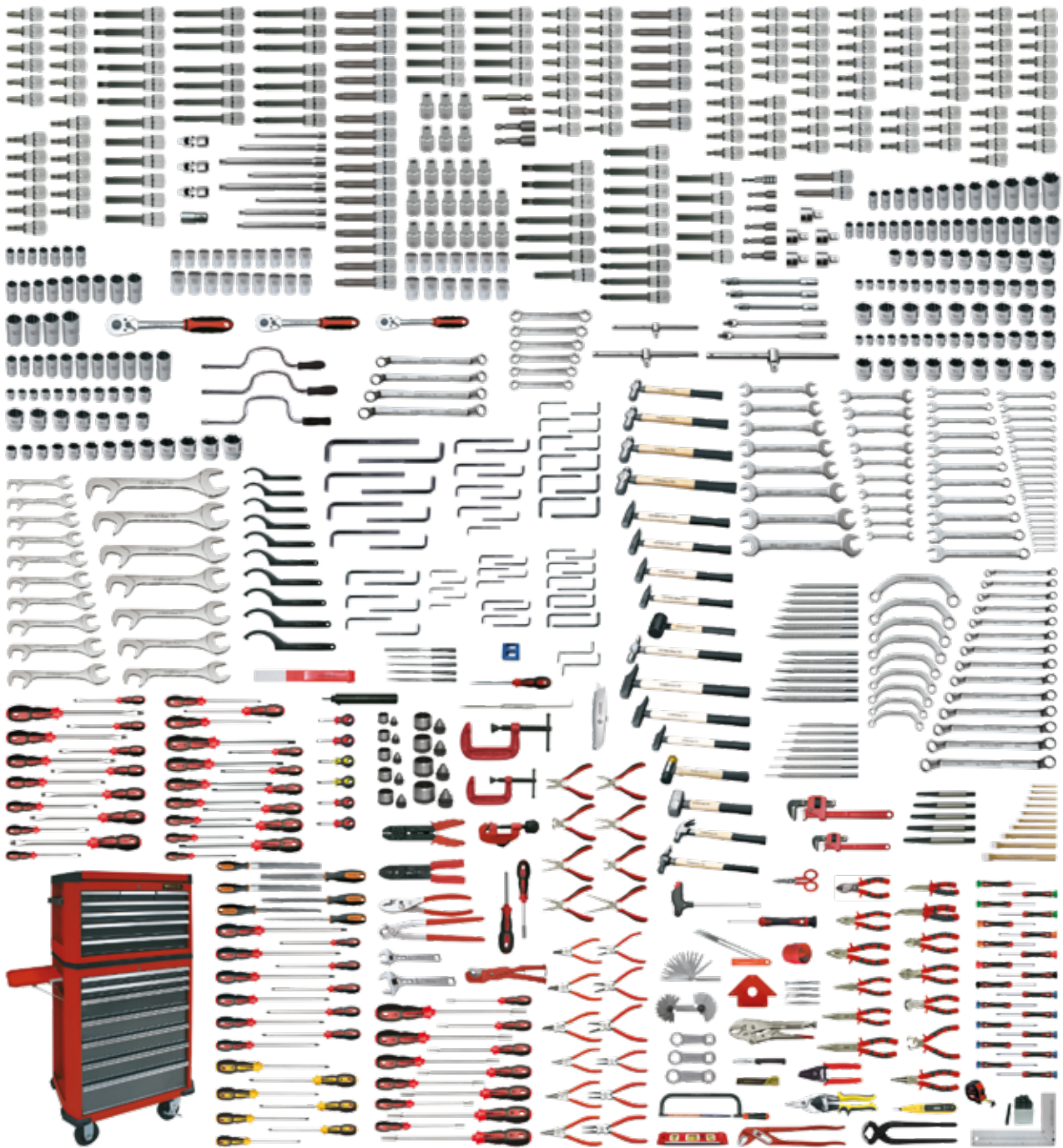
INCH



COD.	PCS.		Medidas en / Sizes in / Mesures en		Kg
51686					95
51687	802	51117	inch		220
51688		51074		●	350



PCS.	Composición / Composition / Composition	Descripción / Description / Description	
1	65880		1/4"
2	65881, 65884	Adaptador para llaves de vaso / Adapter for socket wrenches	3/8"
	65882, 65885		1/2"
4	66261, 66262, 66263, 66264	Adaptadores portapuntas magnéticos / Magnetic bit holders	1/4"
1	65603	Agujas de trazar / Scribes	-
3	61442, 61444, 61445		1/4"
5	61447, 61450, 61459, 62118, 62732	Alargaderas / Extensions	3/8"
4	61453, 61455, 61458, 62119		1/2"
13	62331, 62333, 62337, 62338, 62339, 62340, 62341, 62342, 62343, 62345, 62348, 62349, 62370	Alicates / Pliers	
12	62180, 62181, 62182, 62183, 62215, 62216, 62219, 62220, 62223, 62224, 62227, 62228	Alicates Circlips / Circlips pliers	
2	62493, 62494	Alicates de terminales / Crimping pliers	
9	62241, 62242, 62243, 62244, 62245, 62246, 62247, 62248, 62249	Alicates mini / Mini Pliers	-
	62092	Alicates tipo Ford / Slip joint pliers	
	63745	Arcos de sierra / Hack saws	
1	61435		1/4"
	61436	Articulación universal / Universal joint	3/8"
	61437		1/2"
14	63387, 63388, 63389, 63390, 63391, 63392, 63393, 63408, 63409, 63410, 63411, 63412, 63413, 63414	Botadores / Punches	
1	66074	Buscapolos / Voltage tester	
8	62847, 62848, 62849, 62850, 62853, 62854, 62855, 62857	Cinceles / Chisels	
2	65622, 65627	Compases / Calipers	-
1	63915	Cortabridas / Plastic tie cutters	
	69501	Cortadores / Cutters	
3	63097, 63170, 63199	Cortatubos / Tube cutters	
1	66732	Destornillador portavasos / Socket holder	1/4"
3	55371, 66526, 66527	Destornilladores carroceros / Stubby screwdrivers	
15	55372, 55373, 55374, 55375, 55376, 55378, 55379, 55380, 55382, 55383, 55385, 55397, 55399, 55401, 66518	Destornilladores de vaso / Socket screwdrivers	
8	55352, 55354, 55355, 55357, 55358, 55359, 55360, 55361	Destornilladores electricista / Electrician screwdrivers	
11	55328, 55329, 55330, 55331, 55332, 55333, 55334, 55335, 55337, 55338, 55341	Destornilladores mecánicos / Slotted screwdrivers	
18	55449, 55450, 55451, 55452, 55453, 55457, 66850, 66851, 66852, 66853, 66854, 66866, 66867, 66868, 66869, 66870, 66871, 66872	Destornilladores Microtronic / Microtronic screwdrivers	
8	66437, 66438, 66439, 66440, 66441, 66442, 66443, 67192	Destornilladores Phillips® / Phillips® screwdriver	
4	66249, 66731, 66843, 66844	Destornilladores portapuntas / Bitholder screwdrivers	
8	66456, 66457, 66458, 66459, 66460, 66472, 66473, 67193	Destornilladores Pozidriv® / Pozidriv® screwdrivers	
3	66530, 66531, 66532	Destornilladores Robertson / Screwdrivers Robertson	
13	66487, 66488, 66489, 66490, 66491, 66492, 66493, 66494, 66495, 66496, 66497, 66498, 66499	Destornilladores Tamper Torx / Screwdrivers Tamper Torx	
1	63085	Escariadores / Reamers	-
	65766	Escuadra magnética para soldadura / Magnetic welding square	
2	65768, 65813	Escuadras / Squares	
8	61583, 61584, 61585, 61586, 61587, 61588, 61589, 61590	Extractores de tornillos / Screw extractors	
1	65361	Flexómetros / Measuring tapes	
6	63429, 63430, 63431, 63432, 63433, 63434	Granetes / Center punches	
1	65852	Juegos de golpe números / Punches numbers	
11	63504, 63540, 63576, 63612, 63648, 63684, 63714, 63715, 63717, 63718, 63719	Limas / Files	
1	58641	Linternas / Flashlights	
12	60380, 60381, 60382, 60384, 60385, 60388, 60390, 60391, 67886, 67887, 67888, 67893	Llaves acodadas / Double offset ring wrenches	
2	61110, 61113	Llaves ajustables / Adjustable wrenches	
30	58460, 58461, 58462, 58463, 58464, 58465, 58466, 58467, 60340, 60341, 60342, 60343, 60344, 60345, 60346, 60347, 60348, 60349, 60350, 60351, 60352, 60353, 60354, 60355, 60356, 60358, 67878, 67885, 67953, 67954	Llaves combinadas / Combination wrenches	
	62603		1/4"
1	62604	Llaves de carraca reversible / Reversible ratchet handles	3/8"
	62606		1/2"
10	68283, 68284, 68285, 68286, 68287, 68288, 68289, 68290, 68291, 68292	Llaves de gancho / Hook spanners	-
40	55813, 55814, 56015, 56017, 56018, 56019, 56020, 56021, 56023, 56024, 56025, 56026, 56027, 57165, 57166, 57167, 57168, 57169, 57170, 63989, 63990, 63991, 63992, 63993, 63994, 63995, 63996, 63997, 63998, 67689, 67690, 67691, 67692, 67693, 67694, 67695, 67696, 67697, 67698, 67699		1/4"
33	57173, 57174, 57175, 57176, 57177, 60439, 60440, 60441, 60442, 60443, 60444, 60445, 60446, 60447, 60448, 60449, 60450, 60451, 60452, 60453, 67750, 67751, 67752, 67753, 67754, 67755, 67756, 67757, 67758, 67759, 67760, 67761, 67762	Llaves de vaso / Socket wrenches	3/8"
50	55795, 55796, 55797, 55798, 55799, 55800, 55801, 55802, 55803, 55804, 55805, 55806, 55807, 55808, 55809, 55810, 55811, 55833, 55834, 57185, 57186, 57187, 60479, 60480, 60481, 60482, 60483, 60484, 60485, 60486, 60487, 60488, 60489, 60490, 60491, 60492, 60493, 60494, 60495, 60496, 60497, 60498, 67805, 67806, 67807, 67808, 67809, 67810, 67811, 67812		1/2"
4	57775, 57776, 57777, 57778	Llaves estrella planas / Double ended flat ring spanners	
5	57718, 57719, 57720, 57721, 57722	Llaves estrella planas Torx / Double ended flat ring spanners Torx	-
25	60300, 60301, 60302, 60303, 60304, 60305, 60306, 60307, 60308, 60309, 60310, 60311, 60312, 60313, 60314, 60315, 67931, 67934, 67939, 67940, 67941, 67942, 67943, 67944, 67945	Llaves fijas / Open-end wrenches	

PCS.	Composición / Composition / Composition	Descripción / Description / Description	
7	55724, 55725, 55726, 55728, 55730, 55732, 55734	Llaves fijas Crowfoot / Open end Crowfoot wrenches	3/8"
8	56210, 56211, 56212, 56213, 56214, 56215, 56216, 56217	Llaves fijas extrafinas / Slim open end wrenches	
13	58537, 58538, 58539, 58540, 58541, 58542, 58543, 58544, 58545, 58546, 58547, 58548, 58549	Llaves fijas micromecánicas a 15° y 75° / 15° and 75° micromech open end wrenches	
29	65315, 65316, 65317, 65318, 65319, 65320, 65321, 65322, 65323, 65324, 65325, 65326, 65327, 65328, 65329, 67671, 68900, 68901, 68902, 68903, 68904, 68905, 68906, 68907, 68908, 68909, 68910, 68911, 68912	Llaves hexagonales / Hexagonal key wrenches	
13	68914, 68915, 68916, 68917, 68918, 68919, 68920, 68921, 68922, 68923, 68924, 68925, 68926	Llaves hexagonales bola / Hexagonal key wrenches ball type	
6	57148, 57149, 57150, 57151, 57152, 57153	Llaves media luna / Half moon spanners	-
7	58752, 58753, 58754, 58755, 58756, 58757, 58758	Llaves para racores / Flare nut spanners	
6	65975, 65976, 65977, 65978, 65979, 65980	Llaves Ribe® / Ribe® wrenches	
2	61001, 61004	Llaves Stillson / Stillson pipe wrenches	
20	56544, 56545, 56546, 56547, 56548, 56549, 56550, 56551, 56552, 56553, 56554, 56556, 56557, 56558, 56559, 56560, 56561, 56562, 56563, 56564	Llaves Tamper Torx / Tamper Torx keys	
	69504	Magnetizador-desmagnetizador / Magnetizer-demagnetizer	
	65874	Mango articulado / Swivel handle	1/4"
1	65875		3/8"
	61438		1/4"
	61439	Mango correrizo en T / Sliding "T" handle	3/8"
	61440		1/2"
13	55326, 69521, 69601, 69603, 69612, 69614, 69617, 69618, 69620, 69675, 69681, 69701, 69712	Martillos / Hammers	
5	68043, 68048, 68050, 68051, 68056	Muelles curvatos / Spring tube benders	
1	69525	Navajas / Penknives	-
	65158	Nivel magnético torpedo / Torpedo Magnetic level	
4	69530, 69531, 69532, 69533	Pinzas / Tweezers	
	55265	Punta portavasos / Socket holder bit	1/4"
1	61695		
	61696	Puntas adaptadoras para vasos / Adapter bits for sockets	3/8"
	61697		1/2"
64	53000, 53001, 53002, 53003, 53004, 53005, 53006, 53007, 53008, 53009, 53010, 53011, 53015, 53016, 53017, 53019, 53020, 53021, 53023, 53024, 53025, 53027, 53028, 53029, 53030, 53031, 53032, 53034, 53035, 53036, 53037, 53038, 53039, 53051, 53052, 53053, 53054, 53055, 53056, 53057, 53058, 53059, 53060, 55670, 55671, 55672, 55673, 55674, 55675, 55676, 55677, 55678, 55679, 58900, 66733, 66734, 66735, 66736, 66737, 66738, 66739, 66740, 66741, 66742		1/4"
65	53065, 53066, 53067, 53068, 53069, 53070, 53071, 53072, 53074, 53075, 53076, 53078, 53079, 53080, 53082, 53083, 53084, 53086, 53087, 53088, 53089, 53098, 53099, 53100, 53101, 53102, 53103, 55680, 55681, 55682, 55683, 55684, 55685, 55686, 55687, 56975, 56976, 56977, 56978, 56979, 56980, 56981, 56982, 56985, 56986, 56987, 56988, 56989, 56990, 56991, 56992, 56993, 58896, 58897, 66760, 66761, 66762, 66763, 66764, 66765, 66766, 66767, 66768, 66769, 66770	Puntas atornilladoras con vaso / Socket bits	3/8"
72	53105, 53107, 53108, 53109, 53110, 53115, 53116, 53117, 53118, 53119, 53120, 53121, 53122, 53123, 53124, 53125, 53127, 53128, 53129, 53131, 53132, 53133, 53134, 53136, 53137, 53138, 53139, 53149, 53150, 53151, 53152, 53153, 53154, 53155, 53156, 53157, 53158, 53159, 55688, 55689, 55690, 55691, 55692, 55693, 55695, 55696, 56896, 56897, 65985, 65986, 65987, 65988, 65989, 65990, 65991, 65992, 66801, 66802, 66803, 66804, 66805, 66806, 66820, 66821, 66822, 66823, 66824, 66825, 66826, 66827, 66828, 66829		1/2"
	65783	Punzón / Awl	
1	65601	Recogedor telescópico / Telescopic joint pick up	
	65831	Reglas / Rulers	
10	64671, 64672, 64673, 64674, 64675, 64676, 64677, 64678, 64679, 64680	Sacabocados / Hollow punches	
2	69570, 69572	Sargentos / Clamps	
5	62123, 62145, 62177, 62284, 62795	Tenazas / Pincers	
3	62169, 62170, 62171	Tijeras / Tin snips	
	69534	Tijeras electricista / Electrician's scissors	
1	65846	Vaso adaptador para puntas / Square drive bit retainer	1/4"
	87628	Limpiador multiusos / Multi-purpose cleaner	250 ml
	63988	Cinta de señalización de seguridad / Safety hazard signs tape	-

■ ≈ 700 PCS.

■ MM

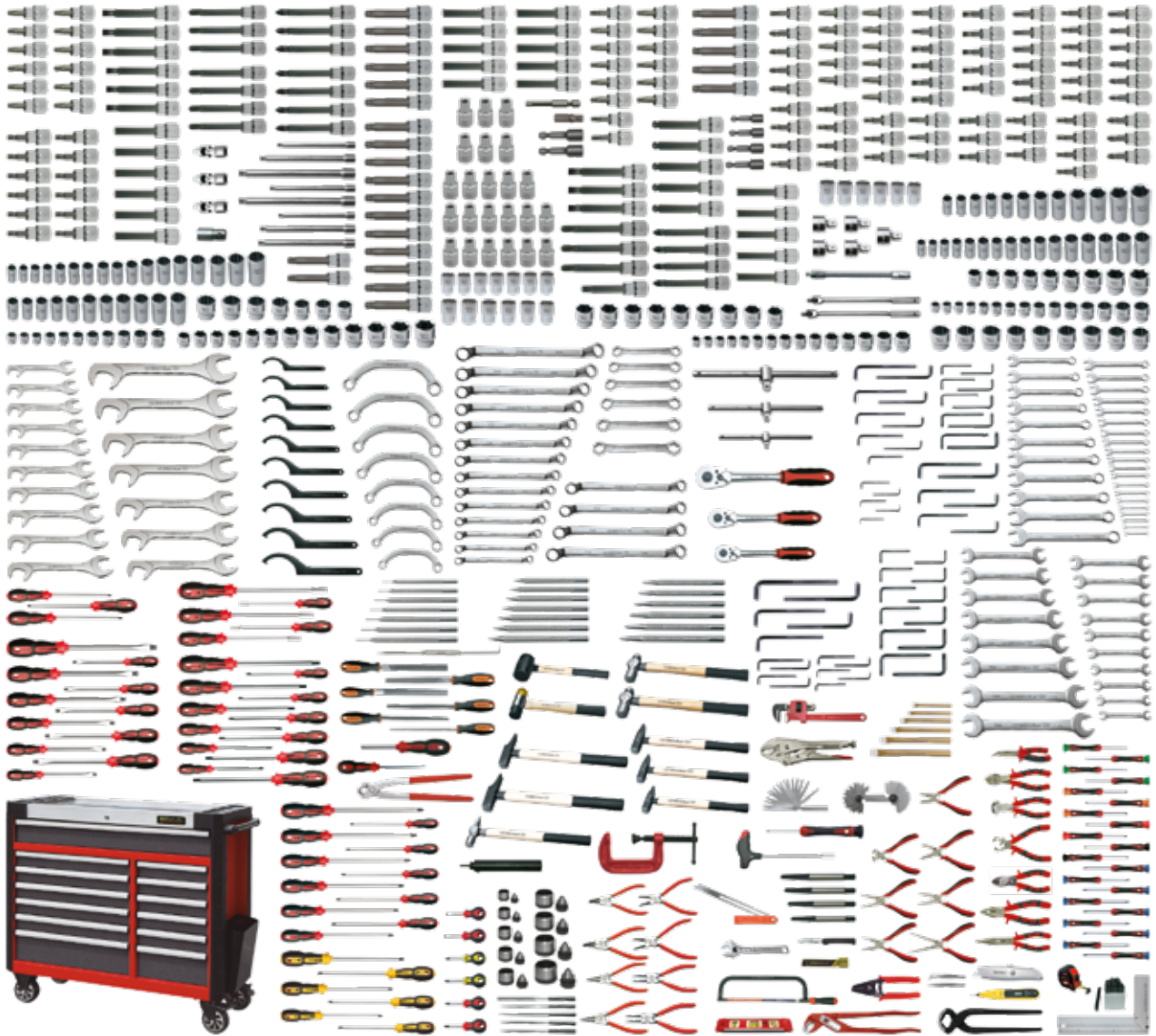

COD.	PCS.		Medidas en / Sizes in / Mesures en	
51689		-		75
51690	713	50954	mm	185
51691		51039, 51117		270

PCS.	Composición / Composition / Composition	Descripción / Description / Description	
1	65880		1/4"
2	65881, 65884	Adaptador para llaves de vaso / Adapter for socket wrenches	3/8"
	65882, 65885		1/2"
1	65603	Agujas de trazar / Scribers	-
4	61442, 61443, 61444, 61445		1/4"
3	61447, 61450, 62732	Alargaderas / Extensions	3/8"
	61453, 61455, 61458		1/2"
6	62331, 62339, 62341, 62343, 62346, 62349	Alicates / Pliers	
8	62180, 62181, 62182, 62183, 62216, 62220, 62224, 62228	Alicates Circlips / Circlips pliers	
	62241, 62242, 62243, 62244, 62245, 62246, 62247, 62249	Alicates mini / Mini Pliers	
	63745	Arcos de sierra / Hack saws	
1	61435	Articulación universal / Universal joint	1/4"

PCS.	Composición / Composition / Composition	Descripción / Description / Description	
1	61436	Articulación universal / Universal joint	3/8"
	61437		1/2"
14	63387, 63388, 63389, 63390, 63391, 63392, 63393, 63408, 63409, 63410, 63411, 63412, 63413, 63414	Botadores / Punches	
1	66074	Buscapolos / Voltage tester	
6	62847, 62848, 62849, 62850, 62853, 62854	Cinceles / Chisels	-
	63915	Cortabridas / Plastic tie cutters	
1	69501	Cortadores / Cutters	
	66732	Destornillador portavasos / Socket holder	1/4"
4	66525, 66526, 66527, 66529	Destornilladores carroceros / Stubby screwdrivers	
5	66509, 66510, 66511, 66512, 66513	Destornilladores de vaso / Socket screwdrivers	
11	66411, 66412, 66420, 66421, 66422, 66423, 66424, 66425, 66426, 66427, 66428	Destornilladores electricista / Electrician screwdrivers	
	66399, 66400, 66401, 66402, 66403, 66404, 66405, 66406, 66407, 66408, 66448	Destornilladores mecánicos / Slotted screwdrivers	
20	57684, 66846, 66847, 66848, 66849, 66850, 66851, 66852, 66853, 66854, 57685, 66864, 66865, 66866, 66867, 66868, 66869, 66870, 66871, 66872	Destornilladores Microtronic / Microtronic screwdrivers	
8	66437, 66438, 66439, 66440, 66441, 66442, 66443, 67192	Destornilladores Phillips® / Phillips® screwdriver	
1	66249	Destornilladores portapuntas / Bitholder screwdrivers	
7	66456, 66457, 66458, 66459, 66472, 66473, 67193	Destornilladores Pozidriv® / Pozidriv® screwdrivers	
3	66530, 66531, 66532	Destornilladores Robertson / Screwdrivers Robertson	
12	66487, 66488, 66489, 66490, 66491, 66492, 66493, 66494, 66495, 66496, 66497, 66498	Destornilladores Tamper Torx / Screwdrivers Tamper Torx	
2	65768, 65813	Escuadras / Squares	
4	61586, 61587, 61588, 61589	Extractores de tornillos / Screw extractors	-
1	65171	Flexómetros / Measuring tapes	
2	65559, 65571	Galgas / Gauges	
6	63429, 63430, 63431, 63432, 63433, 63434	Granetes / Center punches	
1	65852	Juegos de golpe números / Punches numbers	
6	63692, 63714, 63715, 63717, 63718, 63719	Limas / Files	
1	58641	Linternas / Flashlights	
18	61774, 61775, 61776, 61777, 61778, 61779, 61780, 61781, 61782, 61783, 61784, 61785, 61786, 61787, 67843, 67844, 67845, 67855	Llaves acodadas / Double offset ring wrenches	
1	61112	Llaves ajustables / Adjustable wrenches	
31	61725, 61726, 61727, 61728, 61729, 61730, 61731, 61732, 61733, 61734, 61735, 61736, 61737, 61738, 61739, 61740, 61741, 61742, 61743, 61744, 61745, 61746, 61747, 61748, 61749, 61750, 63965, 63966, 63967, 67880, 67881	Llaves combinadas / Combination wrenches	
1	62603		1/4"
1	62604	Llaves de carraca reversible / Reversible ratchet handles	3/8"
	62606		1/2"
10	68283, 68284, 68285, 68286, 68287, 68288, 68289, 68290, 68291, 68292	Llaves de gancho / Hook spanners	-
28	57165, 57166, 57167, 57168, 57169, 57170, 63977, 63978, 63979, 63980, 63981, 63982, 63983, 63984, 63985, 63986, 63987, 67660, 67661, 67662, 67663, 67664, 67665, 67666, 67667, 67668, 67669, 67670		1/4"
43	57171, 57172, 57173, 57174, 57175, 57176, 57177, 57178, 61343, 61344, 61345, 61346, 61347, 61348, 61349, 61350, 61351, 61352, 61353, 61354, 61355, 61356, 61357, 67539, 67540, 67560, 67561, 67725, 67726, 67727, 67728, 67729, 67730, 67731, 67732, 67733, 67734, 67735, 67736, 67737, 67738, 67739, 67740	Llaves de vaso / Socket wrenches	3/8"
69	55795, 55796, 55797, 55798, 55799, 55800, 55801, 55802, 55803, 55804, 55805, 55806, 55807, 55808, 55809, 55810, 55811, 55833, 55834, 57179, 57180, 57181, 57182, 57183, 57184, 57185, 57186, 57187, 61380, 61381, 61382, 61383, 61384, 61385, 61386, 61387, 61388, 61389, 61390, 61391, 61392, 61393, 61394, 61395, 61396, 61397, 61398, 61399, 61400, 61401, 61402, 61403, 67780, 67781, 67782, 67783, 67784, 67785, 67786, 67787, 67788, 67789, 67791, 67792, 67793, 67794, 67795, 67796, 67797		1/2"
6	57718, 57719, 57720, 57721, 57722, 57723	Llaves estrella planas Torx / Double ended flat ring spanners Torx	
16	61701, 61702, 61703, 61704, 61705, 61706, 61707, 61708, 61709, 61710, 61711, 61712, 61713, 67917, 67963, 67967	Llaves fijas / Open-end wrenches	
17	58520, 58521, 58522, 58523, 58524, 58525, 58526, 58527, 58528, 58529, 58530, 58531, 58532, 58533, 58534, 58535, 58536	Llaves fijas micromecánicas a 15° y 75° / 15° and 75° micromech open end wrenches	
34	61501, 61502, 61503, 61504, 61505, 61506, 61517, 61518, 61519, 61525, 61526, 61621, 61622, 61623, 61624, 65302, 65303, 65304, 65306, 65307, 65308, 65309, 65310, 65311, 65330, 65331, 65332, 65519, 65955, 65956, 65958, 67300, 67493, 67494	Llaves hexagonales / Hexagonal key wrenches	-
8	57155, 57156, 57158, 57159, 57160, 57161, 57162, 60795	Llaves media luna / Half moon spanners	
1	61001	Llaves Stillson / Stillson pipe wrenches	
20	56544, 56545, 56546, 56547, 56548, 56549, 56550, 56551, 56552, 56553, 56554, 56556, 56557, 56558, 56559, 56560, 56561, 56562, 56563, 56564	Llaves Tamper Torx / Tamper Torx keys	
	65874		1/4"
	65875	Mango articulado / Swivel handle	3/8"
1	61438		1/4"
	61439	Mango corredizo en T / Sliding "T" handle	3/8"



PCS.	Composición / Composition / Composition	Descripción / Description / Description	
1	61440	Mango correzido en T / Sliding "T" handle	1/2"
10	55326, 69521, 69601, 69612, 69614, 69618, 69620, 69622, 69681, 69701	Martillos / Hammers	
1	69525	Navajas / Penknives	
1	65158	Nivel magnético torpedo / Torpedo Magnetic level	-
2	69530, 69531	Pinzas / Tweezers	
1	55265	Punta portavasos / Socket holder bit	
59	53000, 53001, 53002, 53003, 53004, 53005, 53006, 53007, 53008, 53009, 53010, 53011, 53013, 53015, 53016, 53017, 53019, 53020, 53021, 53023, 53024, 53025, 53034, 53035, 53036, 53037, 53038, 53039, 53041, 53042, 53043, 53044, 53045, 53046, 53047, 53048, 53049, 53050, 55697, 55698, 55699, 55700, 58900, 66733, 66734, 66735, 66736, 66737, 66738, 66739, 66740, 66741, 66742, 66743, 66744, 66745, 66746, 66747, 67164		1/4"
60	53065, 53066, 53067, 53068, 53069, 53070, 53071, 53072, 53074, 53075, 53076, 53078, 53079, 53080, 53082, 53083, 53084, 53086, 53087, 53088, 53089, 53098, 53099, 53100, 53101, 53102, 53103, 55701, 55702, 55703, 58896, 58897, 66760, 66761, 66762, 66763, 66764, 66765, 66766, 66767, 66768, 66769, 66770, 66771, 66772, 66773, 66774, 66775, 66776, 66777, 66778, 66779, 66780, 66781, 66782, 66783, 66784, 66785, 66786, 66787	Puntas atornilladoras con vaso / Socket bits	3/8"
73	53105, 53107, 53108, 53109, 53110, 53115, 53116, 53117, 53118, 53119, 53120, 53121, 53122, 53123, 53127, 53128, 53129, 53131, 53132, 53133, 53134, 53136, 53137, 53138, 53139, 53149, 53150, 53151, 53152, 53153, 53154, 53155, 53156, 53157, 53158, 55704, 55705, 55706, 55707, 55708, 56896, 66801, 66802, 66803, 66804, 66805, 66806, 66807, 66808, 66809, 66810, 66811, 66812, 66813, 66814, 66815, 66816, 66817, 66818, 66819, 66820, 66821, 66822, 66823, 66824, 66825, 66826, 66827, 66828, 66829, 66842, 67213, 67214		1/2"
7	57575, 57576, 66269, 66270, 66271, 66279, 66280	Puntas Stecker / Magnetic Stecker	1/4"
1	65783	Punzón / Awl	
10	64671, 64672, 64673, 64674, 64675, 64676, 64677, 64678, 64679, 64680	Sacabocados / Hollow punches	
1	69570	Sargentos / Clamps	-
5	62123, 62146, 62177, 62284, 62795	Tenazas / Pincers	
1	65846	Vaso adaptador para puntas / Square drive bit retainer	1/4"
1	87628	Limpiador multiusos / Multi-purpose cleaner	250 ml
	63988	Cinta de señalización de seguridad / Safety hazard signs tape	-

# EGGA Master

## ART IN INNOVATION

INCH

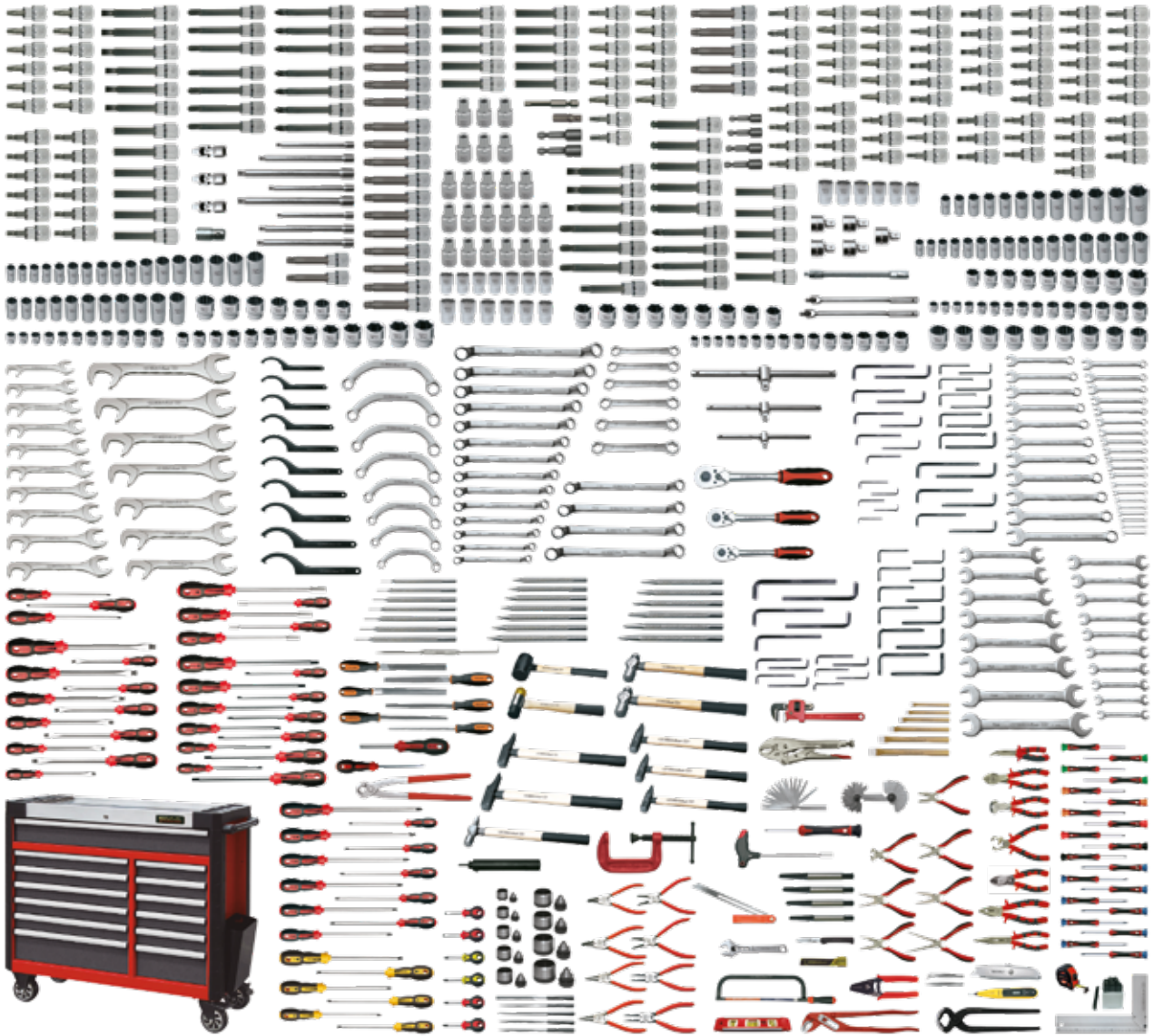

COD.	PCS.	Medidas en / Sizes in / Mesures en	Kg
51692	-	-	75
51693	704	50954	185
51694	-	51039, 51117	270

PCS.	Composición / Composition / Composition	Descripción / Description / Description	
1	65880		1/4"
2	65881, 65884	Adaptador para llaves de vaso / Adapter for socket wrenches	3/8"
	65882, 65885		1/2"
1	65603	Agujas de trazar / Scribers	-
3	61442, 61444, 61445		1/4"
4	61447, 61450, 61459, 62732	Alargaderas / Extensions	3/8"
3	61453, 61455, 61458		1/2"
8	62331, 62337, 62338, 62339, 62341, 62343, 62345, 62349	Alicates / Pliers	
	62180, 62181, 62182, 62183, 62216, 62220, 62224, 62228	Alicates Circlips / Circlips pliers	
9	62241, 62242, 62243, 62244, 62245, 62246, 62247, 62248, 62249	Alicates mini / Mini Pliers	-
	62092	Alicates tipo Ford / Slip joint pliers	
1	63745	Arcos de sierra / Hack saws	
	61435		1/4"
	61436	Articulación universal / Universal joint	3/8"

PCS.	Composición / Composition / Composition	Descripción / Description / Description	
1	61437	Articulación universal / Universal joint	1/2"
14	63387, 63388, 63389, 63390, 63391, 63392, 63393, 63408, 63409, 63410, 63411, 63412, 63413, 63414	Botadores / Punches	
1	66074	Buscapolos / Voltage tester	
6	62847, 62848, 62849, 62850, 62853, 62854	Cinceles / Chisels	
	63915	Cortabridas / Plastic tie cutters	
1	69501	Cortadores / Cutters	
	66732	Destornillador portavasos / Socket holder	1/4"
3	55371, 66526, 66527	Destornilladores carroceros / Stubby screwdrivers	
8	55352, 55354, 55355, 55357, 55358, 55359, 55360, 55361	Destornilladores electricista / Electrician screwdrivers	
11	55328, 55329, 55330, 55331, 55332, 55333, 55334, 55335, 55337, 55338, 55341	Destornilladores mecánicos / Slotted screwdrivers	
18	55449, 55450, 55451, 55452, 55453, 55457, 66850, 66851, 66852, 66853, 66854, 66866, 66867, 66868, 66869, 66870, 66871, 66872	Destornilladores Microtronic / Microtronic screwdrivers	
8	66437, 66438, 66439, 66440, 66441, 66442, 66443, 67192	Destornilladores Phillips® / Phillips® screwdriver	
1	66249	Destornilladores portapuntas / Bitholder screwdrivers	
8	66456, 66457, 66458, 66459, 66460, 66472, 66473, 67193	Destornilladores Pozidriv® / Pozidriv® screwdrivers	
3	66530, 66531, 66532	Destornilladores Robertson / Screwdrivers Robertson	
13	66487, 66488, 66489, 66490, 66491, 66492, 66493, 66494, 66495, 66496, 66497, 66498, 66499	Destornilladores Tamper Torx / Screwdrivers Tamper Torx	
1	65766	Escuadra magnética para soldadura / Magnetic welding square	
	65768	Escuadras / Squares	
7	61583, 61584, 61585, 61586, 61587, 61588, 61589	Extractores de tornillos / Screw extractors	
1	65361	Flexómetros / Measuring tapes	
6	63429, 63430, 63431, 63432, 63433, 63434	Granetes / Center punches	
1	65852	Juegos de golpe números / Punches numbers	
10	63504, 63576, 63612, 63648, 63684, 63714, 63715, 63717, 63718, 63719	Limas / Files	
1	58641	Linternas / Flashlights	
12	60380, 60381, 60382, 60384, 60385, 60388, 60390, 60391, 67886, 67887, 67888, 67893	Llaves acodadas / Double offset ring wrenches	
1	61110	Llaves ajustables / Adjustable wrenches	
	58460, 58461, 58462, 58463, 58464, 58465, 58466, 58467, 60340, 60341, 60342, 60343, 60344, 60345, 60346, 60347, 60348, 60349, 60350, 60351, 60352, 60353, 60354, 60355, 60356, 60358, 67878, 67885, 67953, 67954	Llaves combinadas / Combination wrenches	
1	62603	Llaves de carraca reversible / Reversible ratchet handles	1/4"
	62604		3/8"
	62606		1/2"
9	68283, 68284, 68285, 68286, 68287, 68288, 68289, 68290, 68292	Llaves de gancho / Hook spanners	
40	55813, 55814, 56015, 56017, 56018, 56019, 56020, 56021, 56023, 56024, 56025, 56026, 56027, 57165, 57166, 57167, 57168, 57169, 57170, 63989, 63990, 63991, 63992, 63993, 63994, 63995, 63996, 63997, 63998, 67689, 67690, 67691, 67692, 67693, 67694, 67695, 67696, 67697, 67698, 67699	Llaves de vaso / Socket wrenches	1/4"
31	57173, 57174, 57175, 57176, 57177, 60439, 60440, 60441, 60442, 60443, 60444, 60445, 60446, 60447, 60448, 60449, 60450, 60451, 60452, 60453, 67750, 67751, 67752, 67753, 67754, 67755, 67756, 67757, 67758, 67759, 67761	Llaves de vaso / Socket wrenches	3/8"
50	55795, 55796, 55797, 55798, 55799, 55800, 55801, 55802, 55803, 55804, 55805, 55806, 55807, 55808, 55809, 55810, 55811, 55833, 55834, 57185, 57186, 57187, 60479, 60480, 60481, 60482, 60483, 60484, 60485, 60486, 60487, 60488, 60489, 60490, 60491, 60492, 60493, 60494, 60495, 60496, 60497, 60498, 67805, 67806, 67807, 67808, 67809, 67810, 67811, 67812	Llaves de vaso / Socket wrenches	1/2"
4	57775, 57776, 57777, 57778	Llaves estrella planas / Double ended flat ring spanners	
5	57718, 57719, 57720, 57721, 57722	Llaves estrella planas Torx / Double ended flat ring spanners Torx	
25	60300, 60301, 60302, 60303, 60304, 60305, 60306, 60307, 60308, 60309, 60310, 60311, 60312, 60313, 60314, 60315, 67931, 67934, 67939, 67940, 67941, 67942, 67943, 67944, 67945	Llaves fijas / Open-end wrenches	
8	56210, 56211, 56212, 56213, 56214, 56215, 56216, 56217	Llaves fijas extrafinas / Slim open end wrenches	
12	58537, 58538, 58539, 58540, 58541, 58542, 58543, 58544, 58545, 58546, 58547, 58548	Llaves fijas micromecánicas a 15° y 75° / 15° and 75° micromech open end wrenches	
29	65315, 65316, 65317, 65318, 65319, 65320, 65321, 65322, 65323, 65324, 65325, 65326, 65327, 65328, 65329, 67671, 68900, 68901, 68902, 68903, 68904, 68905, 68906, 68907, 68908, 68909, 68910, 68911, 68912	Llaves hexagonales / Hexagonal key wrenches	
13	68914, 68915, 68916, 68917, 68918, 68919, 68920, 68921, 68922, 68923, 68924, 68925, 68926	Llaves hexagonales bola / Hexagonal key wrenches ball type	
5	57148, 57149, 57150, 57151, 57152	Llaves media luna / Half moon spanners	
	58752, 58753, 58754, 58756, 58758	Llaves para racores / Flare nut spanners	
6	65975, 65976, 65977, 65978, 65979, 65980	Llaves Ribe® / Ribe® wrenches	
1	61001	Llaves Stillson / Stillson pipe wrenches	
20	56544, 56545, 56546, 56547, 56548, 56549, 56550, 56551, 56552, 56553, 56554, 56556, 56557, 56558, 56559, 56560, 56561, 56562, 56563, 56564	Llaves Tamper Torx / Tamper Torx keys	
	69504	Magnetizador-desmagnetizador / Magnetizer-demagnetizer	
	65874	Mango articulado / Swivel handle	
1	61438	Mango correrizo en T / Sliding "T" handle	1/4"
	61439		3/8"
	61440		1/2"

PCS.	Composición / Composition / Composition	Descripción / Description / Description	
9	55326, 69521, 69601, 69612, 69614, 69618, 69620, 69681, 69701	Martillos / Hammers	
1	69525	Navajas / Penknives	-
	65158	Nivel magnético torpedo / Torpedo Magnetic level	
2	69530, 69531	Pinzas / Tweezers	
	55265	Punta portavasos / Socket holder bit	1/4"
1	61695	Puntas adaptadoras para vasos / Adapter bits for sockets	3/8"
	61696		1/2"
	61697		
64	53000, 53001, 53002, 53003, 53004, 53005, 53006, 53007, 53008, 53009, 53010, 53011, 53015, 53016, 53017, 53019, 53020, 53021, 53023, 53024, 53025, 53027, 53028, 53029, 53030, 53031, 53032, 53034, 53035, 53036, 53037, 53038, 53039, 53051, 53052, 53053, 53054, 53055, 53056, 53057, 53058, 53059, 53060, 55670, 55671, 55672, 55673, 55674, 55675, 55676, 55677, 55678, 55679, 58900, 66733, 66734, 66735, 66736, 66737, 66738, 66739, 66740, 66741, 66742		1/4"
61	53065, 53066, 53067, 53068, 53069, 53070, 53071, 53072, 53074, 53075, 53076, 53078, 53079, 53080, 53082, 53083, 53084, 53086, 53087, 53088, 53089, 53098, 53099, 53100, 53101, 53102, 53103, 55680, 55681, 55682, 55683, 55684, 55685, 55686, 55687, 56975, 56976, 56977, 56978, 56979, 56980, 56981, 56982, 56985, 56986, 56987, 56988, 56991, 56992, 58896, 66760, 66761, 66762, 66763, 66764, 66765, 66766, 66767, 66768, 66769, 66770	Puntas atornilladoras con vaso / Socket bits	3/8"
58	53105, 53107, 53108, 53109, 53110, 53115, 53116, 53117, 53118, 53119, 53120, 53121, 53122, 53123, 53127, 53128, 53129, 53131, 53132, 53133, 53134, 53136, 53137, 53138, 53139, 53149, 53150, 53151, 53152, 53153, 53154, 53155, 53156, 53157, 55688, 55689, 55690, 55691, 55692, 55693, 55695, 55696, 56896, 66801, 66802, 66804, 66805, 66806, 66820, 66821, 66822, 66823, 66824, 66825, 66826, 66827, 66828, 66829		1/2"
1	65783	Punzón / Awl	
	65831	Reglas / Rulers	
10	64671, 64672, 64673, 64674, 64675, 64676, 64677, 64678, 64679, 64680	Sacabocados / Hollow punches	
1	69570	Sargentos / Clamps	-
4	62123, 62145, 62177, 62795	Tenazas / Pincers	
	69534	Tijeras electricista / Electrician's scissors	
1	65846	Vaso adaptador para puntas / Square drive bit retainer	1/4"
	87628	Limpiador multiusos / Multi-purpose cleaner	250 ml
	63988	Cinta de señalización de seguridad / Safety hazard signs tape	-



# EGGA Master

## ART IN INNOVATION

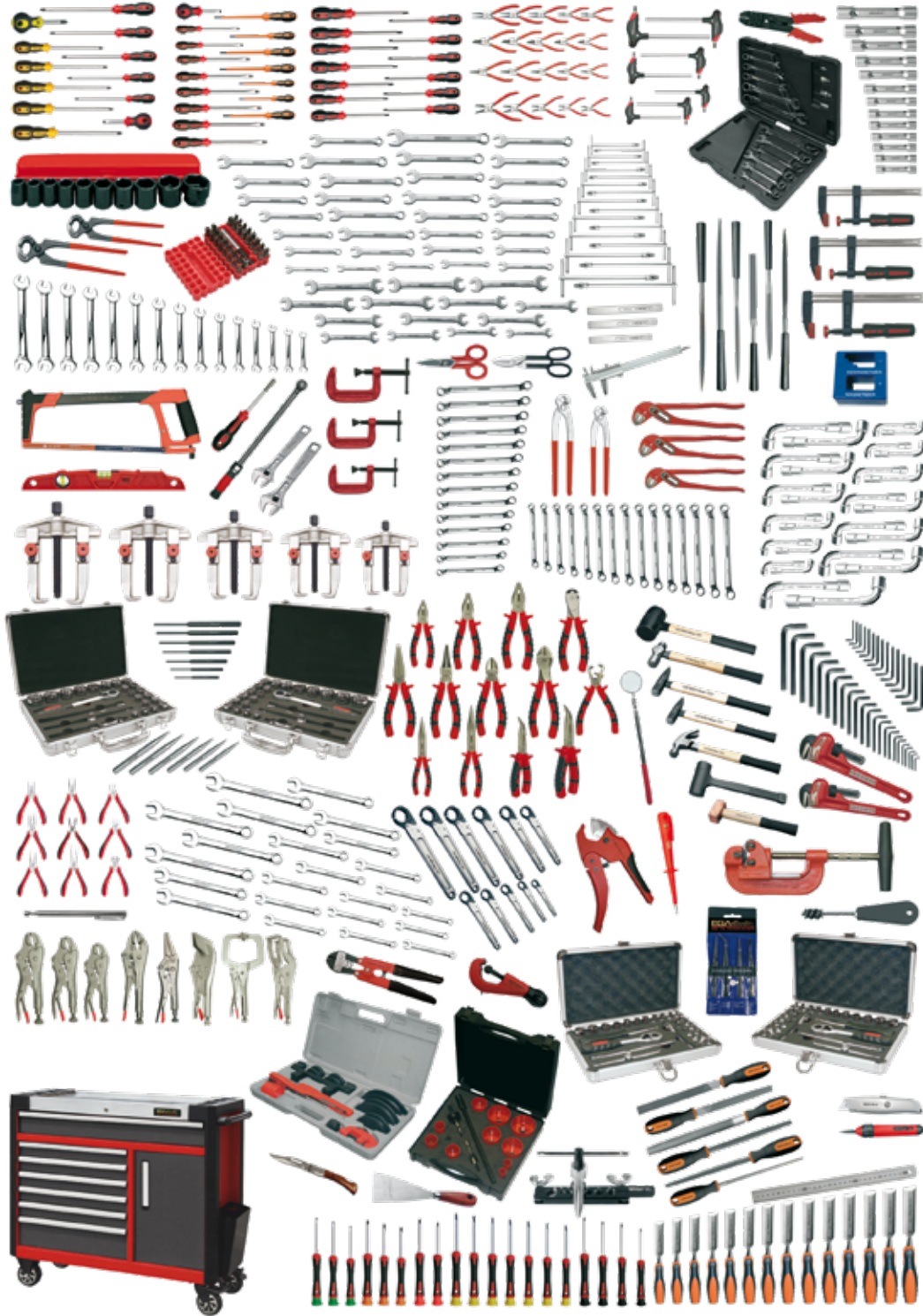

- 632 PCS.
- MM / INCH



COD.	PCS.		Medidas en / Sizes in / Mesures en	
68960	-	-	-	170
68961	632	50950	mm/inch	265
55765	-	50954 (3)	●	506

Si no encuentra el artículo que necesita, consúltenos en [consulta@egamaster.com](mailto:consulta@egamaster.com) o en [www.egamaster.com](http://www.egamaster.com)  
 If you can't find the item you look for, please ask us in [consulta@egamaster.com](mailto:consulta@egamaster.com) or in [www.egamaster.com](http://www.egamaster.com)  
 Si vous ne trouvez pas l'article que vous desirez, consultez-nous a [consulta@egamaster.com](mailto:consulta@egamaster.com) ou a [www.egamaster.com](http://www.egamaster.com)

PCS.	Composición / Composition / Composition	Descripción / Description / Description	
20	62214, 62215, 62216, 62217, 62218, 62219, 62220, 62221, 62222, 62223, 62224, 62225, 62226, 62227, 62228, 62229, 62180, 62181, 62182, 62183	Alicates Circlips / Circlips pliers	
9	66400, 66401, 66403, 66405, 66407, 66408, 66409, 66410, 66525	Destornilladores mecánicos / Slotted screwdrivers	
7	76620, 76621, 76622, 76624, 76625, 76626, 76627	Destornilladores electricistas / Electrician screwdrivers	
6	66438, 66439, 66440, 66441, 66442, 66526	Destornilladores Phillips® / Phillips® screwdriver	
	66456, 66457, 66458, 66459, 66460, 66527	Destornilladores Pozidriv® / Pozidriv® screwdrivers	
13	66474, 66475, 66476, 66477, 66478, 66479, 66480, 66481, 66482, 66483, 66484, 66485, 66486	Destornilladores Torx® / Torx® screwdrivers	-
7	66571, 66572, 66573, 66574, 66575, 66576, 66577	Destornilladores T-Mastertork / T-Mastertork screwdrivers	
16	69870	Set reversible Mastergear / Set rev. Mastergear	
13	61824, 61825, 61826, 61827, 61828, 61829, 61830, 61831, 61832, 61833, 61834, 61835, 61836	Llaves de tubo doble boca / Socket double ended wrench	
18	61840, 61841, 61842, 61843, 61844, 61845, 61846, 61847, 61848, 61849, 61850, 61851, 61852, 61853, 61854, 61855, 61856, 61858	Llaves articuladas en T / T-handle wrenches with universal joint	
32	61725, 61726, 61727, 61728, 61729, 61730, 61731, 61732, 61733, 61734, 61735, 61736, 61737, 61738, 61739, 61740, 61741, 61742, 61743, 61744, 61745, 61746, 61747, 61748, 61749, 61750, 60951, 60952, 60953, 60954, 60955, 60956	Llaves combinadas / Combination wrenches	mm
23	60340, 60341, 60342, 60343, 60344, 60345, 60346, 60347, 60348, 60349, 60350, 60351, 60352, 60353, 60354, 60355, 60356, 60357, 60358, 60957, 60958, 60959, 60960		inch
14	61700, 61701, 61702, 61703, 61704, 61705, 61706, 61707, 61708, 61709, 61710, 61711, 61712, 61713	Llaves fijas / Open-end wrenches	mm
15	60300, 60301, 60302, 60303, 60304, 60305, 60306, 60307, 60308, 60309, 60310, 60311, 60312, 60313, 60314		inch
16	61775, 61776, 61777, 61778, 61779, 61780, 61781, 61782, 61783, 61784, 61785, 61786, 61787, 61788, 61789, 61790	Llaves acodadas / Double offset ring wrenches	mm
15	60380, 60381, 60382, 60383, 60384, 60385, 60386, 60387, 60388, 60389, 60390, 60391, 60392, 60393, 60394		inch
25	61960	Juego / Set	1/2", mm, 25 pcs
	61963		1/2", inch, 25 pcs
26	61870, 61871, 61872, 61873, 61874, 61875, 61876, 61877, 61878, 61879, 61880, 61881, 61882, 61883, 61884, 61885, 61886, 61887, 61888, 61889, 61890, 61891, 61892, 61893, 61894, 61895	Llaves de pipa / Angled sockets	-
23	65302, 65303, 65304, 65305, 65306, 65307, 65308, 65309, 65310, 65311, 65312, 65313, 65314, 61501, 61502, 61503, 61504, 61505, 61506, 61507, 61508, 61509, 61510	Llaves hexagonales / Hexagonal keys	mm
15	65315, 65316, 65317, 65318, 65319, 65320, 65321, 65322, 65323, 65324, 65325, 65326, 65327, 65328, 65329		inch
7	63401, 63402, 63403, 63404, 63405, 63406, 63407	Botadores octogonales / Octagonal punches	
6	63435, 63436, 63437, 63438, 63439, 63440	Granetes hexagonales / Hexagonal center punches	
3	63178, 63179, 63180	Cortafíos / Chisel	
13	62331, 62332, 62333, 62337, 62338, 62339, 62340, 62341, 62342, 62343, 62344, 62345, 62349	Alicates / Pliers	
9	62241, 62242, 62243, 62244, 62245, 62246, 62247, 62248, 62249	Alicates mini / Mini Pliers	
3	62133, 62134, 62135	Tenazas de canal / Box joint pincers	
2	61112, 61114	Llave ajustable / Adjustable wrench	
5	62586, 62587, 62588, 62589, 62590	Extractores / Gear pullers	
1	63748	Arco de sierra / Hack Saw	
29	61958	Juego vasos / Socket set	1/4", mm
	61961		1/4", inch
1	62963	Llave dinamométrica reversible / Reversible torque wrench	1/2", 40-200 nm
7	69614, 69619, 69622, 69750, 69742, 69729, 69521	Martillos / Hammers	
33	66942	Juego puntas / Bits set	-
2	61016, 61018	Llave HD / HD Pipe wrench	12"
8	62177, 62178, 62172, 62231, 62486, 62487, 62508, 62490,	Tenazas Grip / Grip pincers	
6	63498, 63534, 63570, 63606, 63642, 63678	Limas / Files	
	62233	Tijera de chapa / Tin snip	
1	69534	Tijera electricista / Electrician's scissors	-
	65479	Calibre / Caliper	
	69570, 69572, 69575	Sargentos G / G Clamps	
3	69582, 69586, 69588	Sargentos F / F Clamps	
1	65155	Nivel trapezoidal profesional / Professional bridge type spirit level	400 mm
	66731	Destornillador portapuntas magnético / Screwdriver magnetic bitholder	
10	60693		mm
11	61267	Juego de vasos impacto / Impact socket sets	inch
2	62123, 62124	Tenaza rusa / Tower pincer	9", 10"
	62438, 62440	Tenaza carpintero / Carpenter pincer	
4	69529	Set 4 pinzas / Set 4 tweezers	-
1	62493	Alicate de terminales / Crimping pliers	

PCS.	Composición / Composition / Composition	Descripción / Description / Description	
11	65089, 65090, 65091, 65092, 65093, 65095, 65096, 65098, 65099, 65100, 65102	Llaves de carraca para racores / Ratcheting ring wrench	
19	66846, 66848, 66849, 66850, 66851, 66852, 66853, 66854, 66855, 66856, 66857, 66858, 66859, 66860, 66861, 57684, 57685, 66864, 66865	Juego destornilladores Microtronic / Microtronic screwdriver set	-
1	69504	Magnetizador-desmagnetizador / Magnetizer-demagnetizer	
	65362	Flexómetros / Measuring tape	3m/10'
6	63714, 63715, 63716, 63717, 63718, 63719	Limas de aguja / Needle files	
	65595	Recogedor telescópico / Telescopic joing pick up	-
	65586	Espejo articulado / Joint telescopic mirror	
1	65774	Regla / Ruler	300 mm
	63119	Cortatubos cobre / Cooper tube cutter	42 mm
	63376	Rasqueta / Scraper	
	63208	Cepillos / Brushes	-
7	68172	Set curvatubos carraca / Ratchet tube bender set	mm
	68001	Abocinador / Pulg flaring tool	inch
1	63172	Cortatubos acero / Steel tube cutter	2"
	63205	Cortatubos plástico Piraina / Piraina plastic pipe cutter	
13	67169, 67170, 67171, 67172, 67173, 67174, 67175, 67176, 67177, 67178, 67179, 67180, 67181	Formones / Firmer chisels	-
1	62200	Cortavarillas / Bolt cutters	8"
	69501	Cutter	
14	64616	Set sierra de coronas / Bimetal hole saws set	
	67022	Espátula / Scraper	-
	65388	Navaja / Penknife	
1	66073	Tester	
	87628	Limpiador multiusos / Multi-purpose cleaner	250 ml
	63988	Cinta de señalización de seguridad / Safety hazard signs tape	-

# EGGA Master

## ART IN INNOVATION

■ ≈ 600 PCS.

■ MM

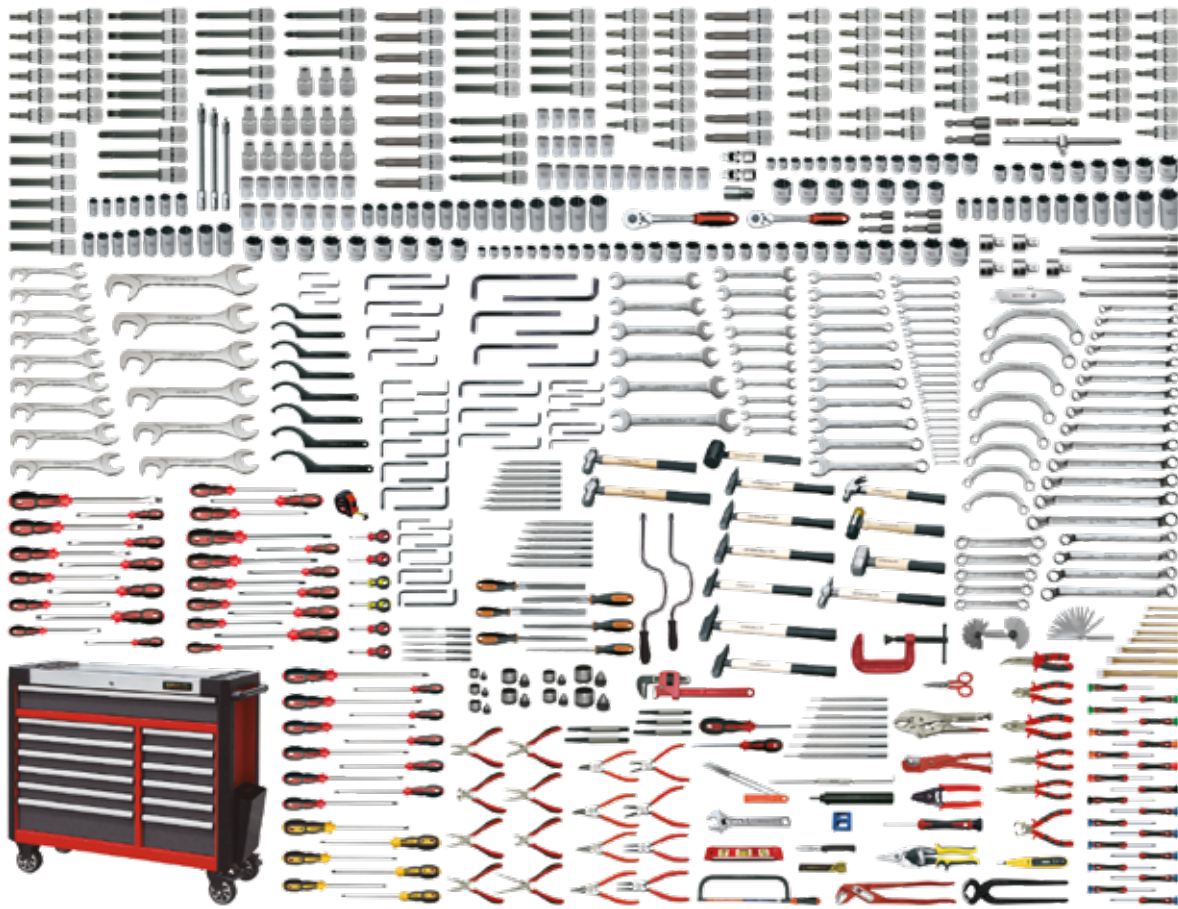

COD.	PCS.		Medidas en / Sizes in / Mesures en	
<b>51695</b>				70
<b>51696</b>	606	50954	mm	180
<b>51697</b>		51674, 51117		240

PCS.	Composición / Composition / Composition	Descripción / Description / Description	
1	65880		1/4"
2	65881, 65884	Adaptador para llaves de vaso / Adapter for socket wrenches	3/8"
	65882, 65885		1/2"
1	65603	Agujas de trazar / Scribers	-
4	61442, 61443, 61444, 61445	Alargaderas / Extensions	1/4"
3	61453, 61455, 61458		1/2"
6	62331, 62337, 62339, 62341, 62343, 62349	Alicates / Pliers	
8	62180, 62181, 62182, 62183, 62216, 62220, 62224, 62228	Alicates Circlips / Circlips pliers	-
9	62241, 62242, 62243, 62244, 62245, 62246, 62247, 62248, 62249	Alicates mini / Mini Pliers	
	63745	Arcos de sierra / Hack saws	
	61435		1/4"
1	61437	Articulación universal / Universal joint	1/2"
	61408		1/4"
	61434	Berbiquí / Speeder Handle	1/2"
14	63387, 63388, 63389, 63390, 63391, 63392, 63393, 63408, 63409, 63410, 63411, 63412, 63413, 63414	Botadores / Punches	
1	66074	Buscapolos / Voltage tester	
8	62847, 62848, 62849, 62850, 62853, 62854, 62855, 62856	Cinceles / Chisels	-
	63915	Cortabridas / Plastic tie cutters	
	69501	Cortadores / Cutters	
1	63199	Cortatubos / Tube cutters	
	66732	Destornillador portavasos / Socket holder	1/4"
4	66525, 66526, 66527, 66529	Destornilladores carroceros / Stubby screwdrivers	-



PCS.	Composición / Composition / Composition	Descripción / Description / Description	
11	66411, 66412, 66420, 66421, 66422, 66423, 66424, 66425, 66426, 66427, 66428	Destornilladores electricista / Electrician screwdrivers	
12	66399, 66400, 66401, 66402, 66403, 66404, 66405, 66406, 66407, 66408, 66409, 66448	Destornilladores mecánicos / Slotted screwdrivers	
20	57684, 66846, 66847, 66848, 66849, 66850, 66851, 66852, 66853, 66854, 57685, 66864, 66865, 66866, 66867, 66868, 66869, 66870, 66871, 66872	Destornilladores Microtronic / Microtronic screwdrivers	
8	66437, 66438, 66439, 66440, 66441, 66442, 66443, 67192	Destornilladores Phillips® / Phillips® screwdriver	
7	66456, 66457, 66458, 66459, 66472, 66473, 67193	Destornilladores Pozidriv® / Pozidriv® screwdrivers	
3	66530, 66531, 66532	Destornilladores Robertson / Screwdrivers Robertson	
11	66487, 66488, 66489, 66490, 66491, 66492, 66493, 66494, 66495, 66496, 66497	Destornilladores Tamper Torx / Screwdrivers Tamper Torx	
1	65768	Escuadras / Squares	
5	61586, 61587, 61588, 61589, 61590	Extractores de tornillos / Screw extractors	
1	65171	Flexómetros / Measuring tapes	-
2	65559, 65571	Galgas / Gauges	
6	63429, 63430, 63431, 63432, 63433, 63434	Granetes / Center punches	
	63692, 63714, 63715, 63717, 63718, 63719	Limas / Files	
1	58641	Linternas / Flashlights	
18	61774, 61775, 61776, 61777, 61778, 61779, 61780, 61781, 61782, 61783, 61784, 61785, 61786, 61787, 67843, 67844, 67845, 67855	Llaves acodadas / Double offset ring wrenches	
1	61112	Llaves ajustables / Adjustable wrenches	
31	61725, 61726, 61727, 61728, 61729, 61730, 61731, 61732, 61733, 61734, 61735, 61736, 61737, 61738, 61739, 61740, 61741, 61742, 61743, 61744, 61745, 61746, 61747, 61748, 61749, 61750, 63965, 63966, 63967, 67880, 67881	Llaves combinadas / Combination wrenches	
1	62603	Llaves de carraca reversible / Reversible ratchet handles	1/4"
	62606		1/2"
8	68283, 68284, 68285, 68286, 68287, 68288, 68289, 68290	Llaves de gancho / Hook spanners	-
41	55813, 55814, 56015, 56017, 56018, 56019, 56020, 56021, 56023, 56024, 56025, 56026, 56027, 57165, 57166, 57167, 57168, 57169, 57170, 63977, 63978, 63979, 63980, 63981, 63982, 63983, 63984, 63985, 63986, 63987, 67660, 67661, 67662, 67663, 67664, 67665, 67666, 67667, 67668, 67669, 67670	Llaves de vaso / Socket wrenches	1/4"
69	55795, 55796, 55797, 55798, 55799, 55800, 55801, 55802, 55803, 55804, 55805, 55806, 55807, 55808, 55809, 55811, 55833, 57179, 57180, 57181, 57182, 57183, 57184, 57185, 57186, 57187, 61380, 61381, 61382, 61383, 61384, 61385, 61386, 61387, 61388, 61389, 61390, 61391, 61392, 61393, 61394, 61395, 61396, 61397, 61398, 61399, 61400, 61401, 61402, 61403, 67780, 67781, 67782, 67783, 67784, 67785, 67786, 67787, 67788, 67789, 67791, 67792, 67793, 67794, 67795, 67796, 67797, 67799, 67800	Llaves de vaso / Socket wrenches	1/2"
5	57718, 57719, 57720, 57721, 57722	Llaves estrella planas Torx / Double ended flat ring spanners Torx	
14	61701, 61702, 61703, 61704, 61705, 61706, 61707, 61708, 61709, 61710, 61711, 61712, 61713, 67917	Llaves fijas / Open-end wrenches	
15	58520, 58521, 58522, 58523, 58524, 58525, 58526, 58527, 58528, 58529, 58530, 58531, 58532, 58533, 58534	Llaves fijas micromecánicas a 15° y 75° / 15° and 75° micromech open end wrenches	
32	61501, 61502, 61503, 61504, 61505, 61506, 61517, 61518, 61519, 61525, 61526, 61621, 61622, 61623, 61624, 65302, 65303, 65304, 65306, 65307, 65308, 65309, 65310, 65330, 65331, 65332, 65519, 65955, 65956, 65958, 67493, 67494	Llaves hexagonales / Hexagonal key wrenches	-
8	57155, 57156, 57158, 57159, 57160, 57161, 57162, 60795	Llaves media luna / Half moon spanners	
1	61001	Llaves Stillson / Stillson pipe wrenches	
20	56544, 56545, 56546, 56547, 56548, 56549, 56550, 56551, 56552, 56553, 56554, 56556, 56557, 56558, 56559, 56560, 56561, 56562, 56563, 56564	Llaves Tamper Torx / Tamper Torx keys	
1	69504	Magnetizador-desmagnetizador / Magnetizer-demagnetizer	
	61438	Mango correrizo en T / Sliding "T" handle	1/4"
13	55326, 69521, 69601, 69603, 69605, 69612, 69613, 69614, 69618, 69620, 69622, 69681, 69701	Martillos / Hammers	
	69525	Navajas / Penknives	-
1	65158	Nivel magnético torpedo / Torpedo Magnetic level	
	55265	Punta portavosos / Socket holder bit	
59	53000, 53001, 53002, 53003, 53004, 53005, 53006, 53007, 53008, 53009, 53010, 53011, 53013, 53015, 53016, 53017, 53019, 53020, 53021, 53023, 53024, 53025, 53034, 53035, 53036, 53037, 53038, 53039, 53041, 53042, 53043, 53044, 53045, 53046, 53047, 53048, 53049, 53050, 55697, 55698, 55699, 55700, 58900, 66733, 66734, 66735, 66736, 66737, 66738, 66739, 66740, 66741, 66742, 66743, 66744, 66745, 66746, 66747, 67164	Puntas atornilladoras con vaso / Socket bits	1/4"
73	53105, 53107, 53108, 53109, 53110, 53115, 53116, 53117, 53118, 53119, 53120, 53121, 53122, 53123, 53124, 53125, 53127, 53128, 53129, 53131, 53132, 53133, 53134, 53136, 53137, 53138, 53139, 53149, 53150, 53151, 53152, 53153, 53154, 53155, 53156, 55704, 55705, 55706, 55707, 55708, 56896, 66801, 66802, 66803, 66804, 66805, 66806, 66807, 66808, 66809, 66810, 66811, 66812, 66813, 66814, 66815, 66816, 66817, 66818, 66819, 66820, 66821, 66822, 66823, 66824, 66825, 66826, 66827, 66828, 66829, 66842, 67213, 67214	Puntas atornilladoras con vaso / Socket bits	1/2"
7	57575, 57576, 66269, 66270, 66271, 66279, 66280	Puntas Stecker / Magnetic Stecker	1/4"
1	65783	Punzón / Awl	
10	64671, 64672, 64673, 64674, 64675, 64676, 64677, 64678, 64679, 64680	Sacabocados / Hollow punches	
1	69570	Sargentos / Clamps	
3	62146, 62177, 62795	Tenazas / Pincers	-
	62170	Tijeras / Tin snips	
	69534	Tijeras electricista / Electrician's scissors	
1	65846	Vaso adaptador para puntas / Square drive bit retainer	1/4"
	87628	Limpiador multiusos / Multi-purpose cleaner	250 ml
	63988	Cinta de señalización de seguridad / Safety hazard signs tape	-

### INCH

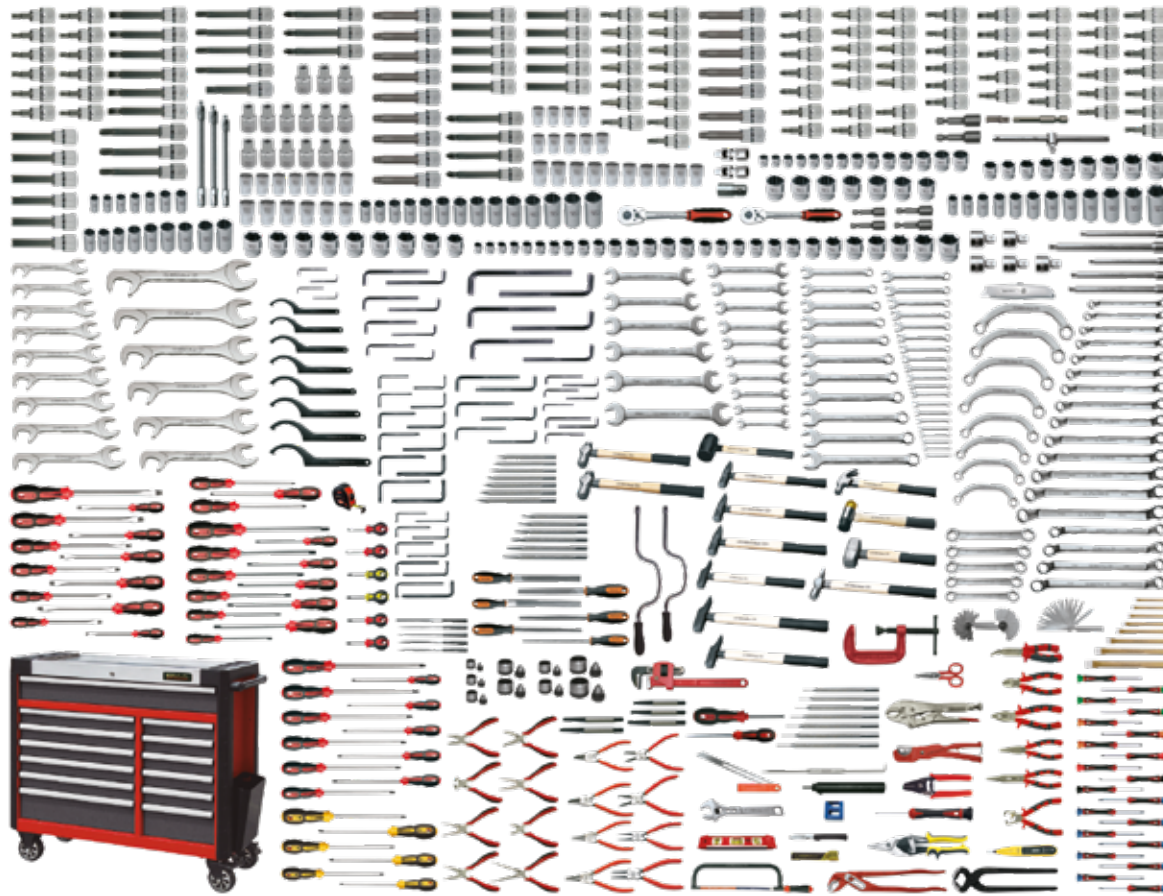

COD.	PCS.		Medidas en / Sizes in / Mesures en	
51698		-		70
51699	615	50954	inch	180
51700		51674, 51117		240

PCS.	Composición / Composition / Composition	Descripción / Description / Description	
1	65880		1/4"
2	65881, 65884	Adaptador para llaves de vaso / Adapter for socket wrenches	3/8"
	65882, 65885		1/2"
4	66261, 66262, 66263, 66264	Adaptadores portapuntas magnéticos / Magnetic bit holders	1/4"
1	65603	Agujas de trazar / Scribers	-
3	61442, 61444, 61445		1/4"
	61453, 61455, 61458	Alargaderas / Extensions	1/2"
6	62331, 62338, 62339, 62341, 62343, 62349	Alicates / Pliers	
8	62180, 62181, 62182, 62183, 62216, 62220, 62224, 62228	Alicates Circlips / Circlips pliers	
	62241, 62242, 62243, 62244, 62245, 62246, 62247, 62249	Alicates mini / Mini Pliers	-
	62092	Alicates tipo Ford / Slip joint pliers	
1	63745	Arcos de sierra / Hack saws	
	61435		1/4"
	61437	Articulación universal / Universal joint	1/2"
14	63387, 63388, 63389, 63390, 63391, 63392, 63393, 63408, 63409, 63410, 63411, 63412, 63413, 63414	Botadores / Punches	
1	66074	Buscapolos / Voltage tester	-
7	62847, 62848, 62849, 62850, 62853, 62854, 62855	Cinceles / Chisels	
1	69501	Cortadores / Cutters	
	66732	Destornillador portavasos / Socket holder	1/4"
3	55371, 66526, 66527	Destornilladores carroceros / Stubby screwdrivers	
8	55352, 55354, 55355, 55357, 55358, 55359, 55360, 55361	Destornilladores electricista / Electrician screwdrivers	
10	55328, 55329, 55330, 55331, 55332, 55333, 55334, 55335, 55337, 55338	Destornilladores mecánicos / Slotted screwdrivers	-
18	55449, 55450, 55451, 55452, 55453, 55457, 66850, 66851, 66852, 66853, 66854, 66866, 66867, 66868, 66869, 66870, 66871, 66872	Destornilladores Microtronic / Microtronic screwdrivers	

PCS.	Composición / Composition / Composition	Descripción / Description / Description	
8	66437, 66438, 66439, 66440, 66441, 66442, 66443, 67192	Destornilladores Phillips® / Phillips® screwdriver	
3	66249, 66843, 66844	Destornilladores portapuntas / Bitholder screwdrivers	
8	66456, 66457, 66458, 66459, 66460, 66472, 66473, 67193	Destornilladores Pozidriv® / Pozidriv® screwdrivers	
3	66530, 66531, 66532	Destornilladores Robertson / Screwdrivers Robertson	
13	66487, 66488, 66489, 66490, 66491, 66492, 66493, 66494, 66495, 66496, 66497, 66498, 66499	Destornilladores Tamper Torx / Screwdrivers Tamper Torx	
1	65768	Escuadras / Squares	
7	61583, 61584, 61585, 61586, 61587, 61588, 61589	Extractores de tornillos / Screw extractors	
1	65361	Flexómetros / Measuring tapes	-
6	63429, 63430, 63431, 63432, 63433, 63434	Granetes / Center punches	
5	63714, 63715, 63717, 63718, 63719	Limas / Files	
1	58641	Linternas / Flashlights	
11	60380, 60381, 60382, 60384, 60385, 60388, 60390, 60391, 67886, 67887, 67888	Llaves acodadas / Double offset ring wrenches	
1	61110	Llaves ajustables / Adjustable wrenches	
30	58460, 58461, 58462, 58463, 58464, 58465, 58466, 58467, 60340, 60341, 60342, 60343, 60344, 60345, 60346, 60347, 60348, 60349, 60350, 60351, 60352, 60353, 60354, 60355, 60356, 60358, 60359, 67885, 67886, 67887, 67888, 67889, 67890, 67891, 67892, 67893, 67894, 67895, 67896, 67897, 67898, 67899	Llaves combinadas / Combination wrenches	
1	62603	Llaves de carraca reversible / Reversible ratchet handles	1/4"
	62606		1/2"
9	68283, 68284, 68285, 68286, 68287, 68288, 68289, 68290, 68292	Llaves de gancho / Hook spanners	-
40	55813, 55814, 56015, 56017, 56018, 56019, 56020, 56021, 56022, 56024, 56025, 56026, 56027, 57165, 57166, 57167, 57168, 57169, 57170, 63998, 63999, 63991, 63992, 63993, 63994, 63995, 63996, 63997, 63998, 67689, 67690, 67691, 67692, 67693, 67694, 67695, 67696, 67697, 67698, 67699	Llaves de vaso / Socket wrenches	1/4"
47	55795, 55796, 55797, 55798, 55799, 55800, 55801, 55802, 55803, 55804, 55805, 55806, 55807, 55808, 55809, 55810, 55811, 55833, 55834, 57185, 57186, 57187, 60479, 60480, 60481, 60482, 60483, 60484, 60485, 60486, 60487, 60488, 60489, 60490, 60491, 60492, 60493, 60494, 60495, 60496, 60497, 60498, 67806, 67807, 67808, 67809, 67811		1/2"
4	57775, 57776, 57777, 57778	Llaves estrella planas / Double ended flat ring spanners	
5	57718, 57719, 57720, 57721, 57722	Llaves estrella planas Torx / Double ended flat ring spanners Torx	
25	60300, 60301, 60302, 60303, 60304, 60305, 60306, 60307, 60308, 60309, 60310, 60311, 60312, 60313, 60314, 60315, 67931, 67934, 67939, 67940, 67941, 67942, 67943, 67944, 67945	Llaves fijas / Open-end wrenches	
12	58537, 58538, 58539, 58540, 58541, 58542, 58543, 58544, 58545, 58546, 58547, 58548	Llaves fijas micromecánicas a 15° y 75° / 15° and 75° micromech open end wrenches	
28	65315, 65316, 65317, 65318, 65319, 65320, 65321, 65322, 65323, 65324, 65325, 65326, 65327, 65328, 67671, 68900, 68901, 68902, 68903, 68904, 68905, 68906, 68907, 68908, 68909, 68910, 68911, 68912	Llaves hexagonales / Hexagonal key wrenches	
13	68914, 68915, 68916, 68917, 68918, 68919, 68920, 68921, 68922, 68923, 68924, 68925, 68926	Llaves hexagonales bola / Hexagonal key wrenches ball type	-
5	57148, 57149, 57150, 57151, 57152	Llaves media luna / Half moon spanners	
6	58752, 58753, 58754, 58755, 58756, 58758	Llaves para racores / Flare nut spanners	
5	65975, 65976, 65977, 65978, 65979	Llaves Ribe® / Ribe® wrenches	
1	61001	Llaves Stillson / Stillson pipe wrenches	
20	56544, 56545, 56546, 56547, 56548, 56549, 56550, 56551, 56552, 56553, 56554, 56556, 56557, 56558, 56559, 56560, 56561, 56562, 56563, 56564	Llaves Tamper Torx / Tamper Torx keys	
	69504	Magnetizador-desmagnetizador / Magnetizer-demagnetizer	
	65874	Mango articulado / Swivel handle	1/4"
1	61438	Mango corrrero en T / Sliding "T" handle	1/2"
	61440		
12	55326, 69521, 69601, 69603, 69612, 69614, 69617, 69618, 69620, 69675, 69681, 69701	Martillos / Hammers	
5	68043, 68048, 68050, 68051, 68056	Muelles curvátubos / Spring tube benders	-
	65158	Nivel magnético torpedo / Torpedo Magnetic level	
	55265	Punta portavasos / Socket holder bit	1/4"
1	61695	Puntas adaptadoras para vasos / Adapter bits for sockets	1/2"
	61697		
64	53000, 53001, 53002, 53003, 53004, 53005, 53006, 53007, 53008, 53009, 53010, 53011, 53015, 53016, 53017, 53019, 53020, 53021, 53023, 53024, 53025, 53027, 53028, 53029, 53030, 53031, 53032, 53034, 53035, 53036, 53037, 53038, 53039, 53051, 53052, 53053, 53054, 53055, 53056, 53057, 53058, 53059, 53060, 55670, 55671, 55672, 55673, 55674, 55675, 55676, 55677, 55678, 55679, 58900, 66733, 66734, 66735, 66736, 66737, 66738, 66739, 66740, 66741, 66742	Puntas atornilladoras con vaso / Socket bits	1/4"
10	55684, 56985, 56986, 56987, 56988, 56989, 56990, 56991, 56992, 56993		3/8"
72	53105, 53107, 53108, 53109, 53110, 53115, 53116, 53117, 53118, 53119, 53120, 53121, 53122, 53123, 53124, 53125, 53127, 53128, 53129, 53131, 53132, 53133, 53134, 53136, 53137, 53138, 53139, 53149, 53150, 53151, 53152, 53153, 53154, 53155, 53156, 53157, 53158, 53159, 55688, 55689, 55690, 55691, 55692, 55693, 55695, 55696, 56896, 56897, 65985, 65986, 65987, 65988, 65989, 65990, 65991, 65992, 66801, 66802, 66803, 66804, 66805, 66806, 66820, 66821, 66822, 66823, 66824, 66825, 66826, 66827, 66828, 66829	Puntas atornilladoras con vaso / Socket bits	1/2"
	65783	Punzón / Awl	
	65831	Reglas / Rulers	
10	64671, 64672, 64673, 64674, 64675, 64677, 64678, 64679, 64680	Sacabocados / Hollow punches	-
1	69570	Sargentos / Clamps	
4	62123, 62145, 62177, 62795	Tenazas / Pincers	
	62170	Tijeras / Tin snips	
	65846	Vaso adaptador para puntas / Square drive bit retainer	1/4"
1	87628	Limpiador multiusos / Multi-purpose cleaner	250 ml
	63988	Cinta de señalización de seguridad / Safety hazard signs tape	-

■ ≈ 500 PCS.

■ MM

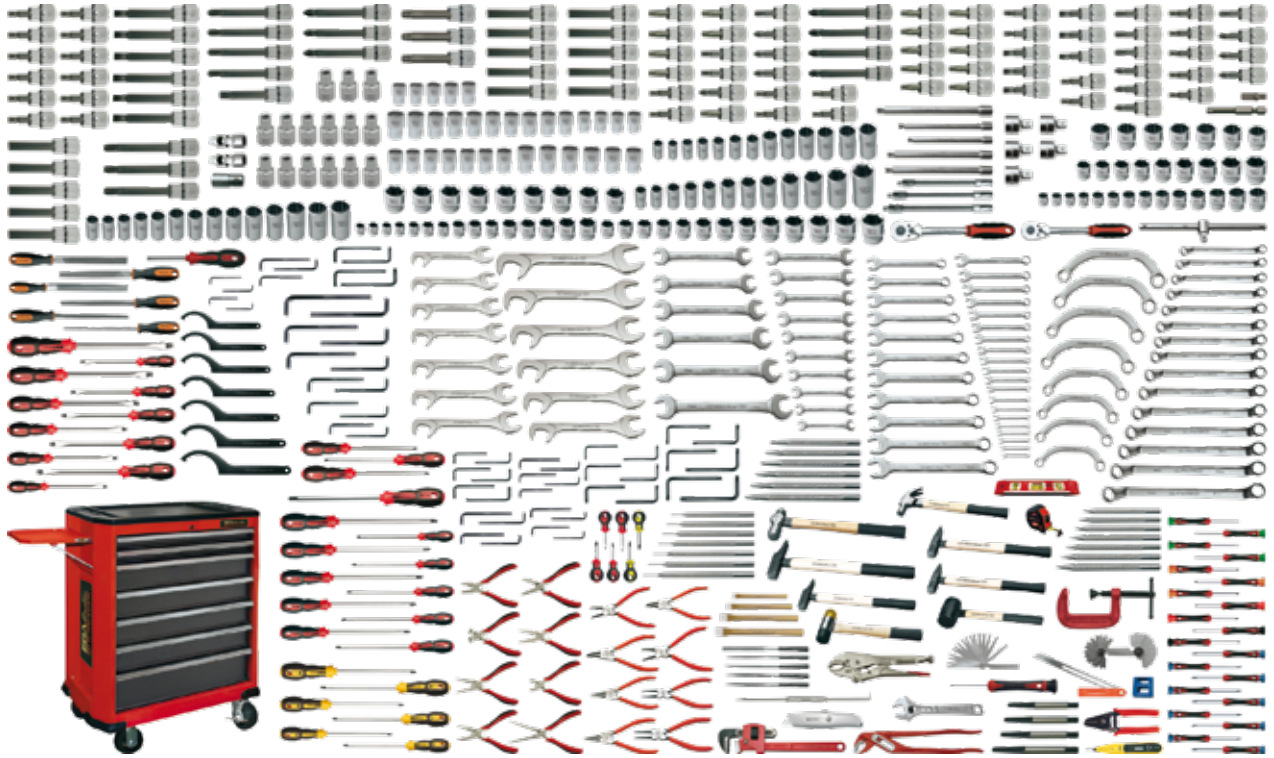

COD.	PCS.	Medidas en / Sizes in / Mesures en	Kg
51701	-	-	50
51702	513	51039 mm	120
51703	-	51117	175

PCS.	Composición / Composition / Composition	Descripción / Description / Description	
1	65880		1/4"
2	65881, 65884	Adaptador para llaves de vaso / Adapter for socket wrenches	3/8"
	65882, 65885		1/2"
1	65603	Agujas de trazar / Scribers	-
4	61442, 61443, 61444, 61445	Alargaderas / Extensions	1/4"
3	61453, 61455, 61458		1/2"
4	62331, 62339, 62341, 62343	Alicates / Pliers	
8	62180, 62181, 62182, 62183, 62216, 62220, 62224, 62228	Alicates Circlips / Circlips pliers	-
5	62241, 62242, 62246, 62247, 62249	Alicates mini / Mini Pliers	
1	61435		1/4"
	61437	Articulación universal / Universal joint	1/2"
14	63387, 63388, 63389, 63390, 63391, 63392, 63393, 63408, 63409, 63410, 63411, 63412, 63413, 63414	Botadores / Punches	
1	66074	Buscapolos / Voltage tester	
4	62847, 62849, 62853, 62854	Cinceles / Chisels	-
	63915	Cortabridas / Plastic tie cutters	
1	69501	Cortadores / Cutters	
	66732	Destornillador portavasos / Socket holder	1/4"
4	66525, 66526, 66527, 66529	Destornilladores carroceros / Stubby screwdrivers	
11	66411, 66412, 66420, 66421, 66422, 66423, 66424, 66425, 66426, 66427, 66428	Destornilladores electricista / Electrician screwdrivers	
	66399, 66400, 66401, 66402, 66403, 66404, 66405, 66406, 66407, 66408, 66448	Destornilladores mecánicos / Slotted screwdrivers	
20	57684, 66846, 66847, 66848, 66849, 66850, 66851, 66852, 66853, 66854, 57685, 66864, 66865, 66866, 66867, 66868, 66869, 66870, 66871, 66872	Destornilladores Microtronc / Microtronic screwdrivers	-
7	66437, 66438, 66439, 66440, 66441, 66443, 67192	Destornilladores Phillips® / Phillips® screwdriver	
	66456, 66457, 66458, 66459, 66472, 66473, 67193	Destornilladores Pozidriv® / Pozidriv® screwdrivers	
3	66530, 66531, 66532	Destornilladores Robertson / Screwdrivers Robertson	
1	66492	Destornilladores Tamper Torx / Screwdrivers Tamper Torx	



PCS.	Composición / Composition / Composition	Descripción / Description / Description	
1	65768	Escuadras / Squares	
4	61586, 61587, 61588, 61589	Extractores de tornillos / Screw extractors	
1	65171	Flexómetros / Measuring tapes	
2	65559, 65571	Galgas / Gauges	
6	63429, 63430, 63431, 63432, 63433, 63434	Granetes / Center punches	
6	63692, 63714, 63715, 63717, 63718, 63719	Limas / Files	
15	61774, 61775, 61776, 61777, 61778, 61779, 61780, 61781, 61782, 61783, 61784, 67843, 67844, 67845, 67855	Llaves acodadas / Double offset ring wrenches	
1	61112	Llaves ajustables / Adjustable wrenches	
31	61725, 61726, 61727, 61728, 61729, 61730, 61731, 61732, 61733, 61734, 61735, 61736, 61737, 61738, 61739, 61740, 61741, 61742, 61743, 61744, 61745, 61746, 61747, 61748, 61749, 61750, 63965, 63966, 63967, 67880, 67881	Llaves combinadas / Combination wrenches	
1	62603	Llaves de carraca reversible / Reversible ratchet handles	1/4"
	62606		1/2"
7	68283, 68284, 68285, 68286, 68287, 68288, 68289	Llaves de gancho / Hook spanners	-
41	55813, 55814, 56015, 56017, 56018, 56019, 56020, 56021, 56023, 56024, 56025, 56026, 56027, 57165, 57166, 57167, 57168, 57169, 57170, 63977, 63978, 63979, 63980, 63981, 63982, 63983, 63984, 63985, 63986, 63987, 67660, 67661, 67662, 67663, 67664, 67665, 67666, 67667, 67668, 67669, 67670		1/4"
66	55795, 55796, 55797, 55798, 55799, 55800, 55801, 55802, 55803, 55804, 55805, 55806, 55807, 55808, 55809, 55811, 55833, 57179, 57180, 57181, 57182, 57183, 57184, 57185, 57186, 57187, 61380, 61381, 61382, 61383, 61384, 61385, 61386, 61387, 61388, 61389, 61390, 61391, 61392, 61393, 61394, 61395, 61396, 61397, 61398, 61399, 61400, 61401, 61402, 61403, 67780, 67781, 67782, 67783, 67784, 67785, 67786, 67787, 67788, 67789, 67791, 67792, 67793, 67794, 67795, 67796	Llaves de vaso / Socket wrenches	1/2"
14	61701, 61702, 61703, 61704, 61705, 61706, 61707, 61708, 61709, 61710, 61711, 61712, 61713, 67917	Llaves fijas / Open-end wrenches	
13	58520, 58521, 58522, 58523, 58524, 58525, 58526, 58527, 58528, 58529, 58530, 58531, 58532	Llaves fijas micromecánicas a 15° y 75° / 15° and 75° micromech open end wrenches	
32	61501, 61502, 61503, 61504, 61505, 61506, 61517, 61518, 61519, 61525, 61526, 61621, 61622, 61623, 61624, 65302, 65303, 65304, 65306, 65307, 65308, 65309, 65310, 65330, 65331, 65332, 65519, 65955, 65956, 65958, 67493, 67494	Llaves hexagonales / Hexagonal key wrenches	-
8	57155, 57156, 57158, 57159, 57160, 57161, 57162, 60795	Llaves media luna / Half moon spanners	
1	61001	Llaves Stillson / Stillson pipe wrenches	
20	56544, 56545, 56546, 56547, 56548, 56549, 56550, 56551, 56552, 56553, 56554, 56556, 56557, 56558, 56559, 56560, 56561, 56562, 56563, 56564	Llaves Tamper Torx / Tamper Torx keys	
1	69504	Magnetizador-desmagnetizador / Magnetizer-demagnetizer	
1	61438	Mango corrrerizo en T / Sliding "T" handle	1/4"
8	55326, 69521, 69601, 69612, 69614, 69618, 69622, 69681	Martillos / Hammers	-
1	65158	Nivel magnético torpedo / Torpedo Magnetic level	
	55265	Punta portavasos / Socket holder bit	
59	53000, 53001, 53002, 53003, 53004, 53005, 53006, 53007, 53008, 53009, 53010, 53011, 53013, 53015, 53016, 53017, 53019, 53020, 53021, 53023, 53024, 53025, 53034, 53035, 53036, 53037, 53038, 53039, 53041, 53042, 53043, 53044, 53045, 53046, 53047, 53048, 53049, 53050, 55697, 55698, 55699, 55700, 58900, 66733, 66734, 66735, 66736, 66737, 66738, 66739, 66740, 66741, 66742, 66743, 66744, 66745, 66746, 66747, 67164	Puntas atornilladoras con vaso / Socket bits	1/4"
48	53105, 53107, 53108, 53109, 53110, 53115, 53116, 53117, 53118, 53119, 53120, 53121, 53122, 53127, 53128, 53129, 53131, 53132, 53133, 53134, 53136, 53137, 53138, 53139, 55704, 55705, 55706, 55707, 55708, 66801, 66802, 66804, 66805, 66806, 66807, 66808, 66809, 66810, 66811, 66812, 66813, 66814, 66815, 66816, 66817, 66818, 67213, 67214		1/2"
1	66280	Puntas Stecker / Magnetic Stecker	1/4"
	69570	Sargentos / Clamps	-
2	62177, 62795	Tenazas / Pincers	
1	65846	Vaso adaptador para puntas / Square drive bit retainer	1/4"

### INCH

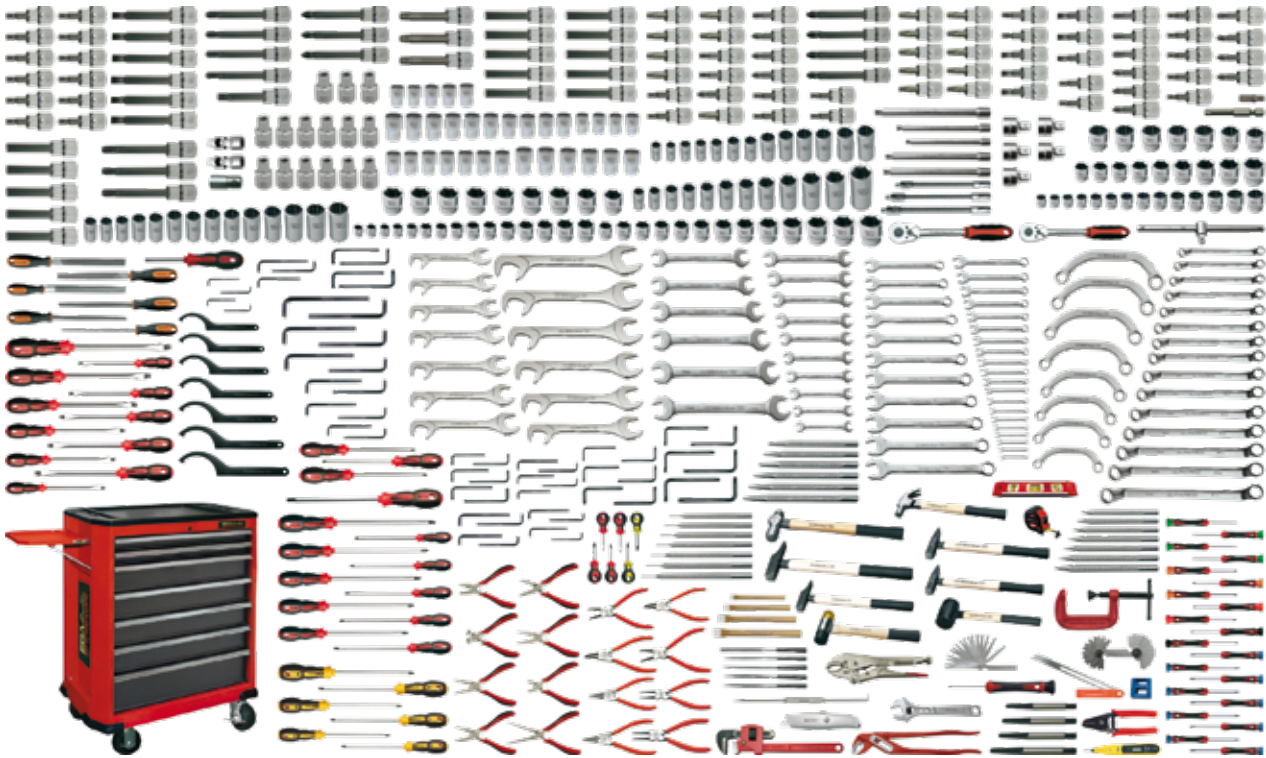



COD.	PCS.	Medidas en / Sizes in / Mesures en	Kg
51704	-	-	50
51705	505	51039	120
51706	-	51117	175

PCS.	Composición / Composition / Composition	Descripción / Description / Description	
1	65880		1/4"
2	65881, 65884	Adaptador para llaves de vaso / Adapter for socket wrenches	3/8"
	65882, 65885		1/2"
1	65603	Agujas de trazar / Scribers	-
3	61442, 61444, 61445	Alargaderas / Extensions	1/4"
	61453, 61455, 61458		1/2"
4	62331, 62339, 62341, 62343	Alicates / Pliers	-
8	62180, 62181, 62182, 62183, 62216, 62220, 62224, 62228	Alicates Circlips / Circlips pliers	-
	62241, 62242, 62243, 62244, 62245, 62246, 62247, 62249	Alicates mini / Mini Pliers	-
1	61435	Articulación universal / Universal joint	1/4"
	61437		1/2"
14	63387, 63388, 63389, 63390, 63391, 63392, 63393, 63408, 63409, 63410, 63411, 63412, 63413, 63414	Botadores / Punches	-
1	66074	Buscapolos / Voltage tester	-
4	62847, 62849, 62853, 62854	Cinceles / Chisels	-
1	69501	Cortadores / Cutters	-
	66732	Destornillador portavasos / Socket holder	1/4"
3	55371, 66526, 66527	Destornilladores carroceros / Stubby screwdrivers	-
8	55352, 55354, 55355, 55357, 55358, 55359, 55360, 55361	Destornilladores electricista / Electrician screwdrivers	-
9	55328, 55330, 55331, 55332, 55333, 55334, 55335, 55337, 55338	Destornilladores mecánicos / Slotted screwdrivers	-
18	55449, 55450, 55451, 55452, 55453, 55457, 66850, 66851, 66852, 66853, 66854, 66866, 66867, 66868, 66869, 66870, 66871, 66872	Destornilladores Microtronc / Microtronic screwdrivers	-
7	66437, 66438, 66439, 66440, 66441, 66443, 67192	Destornilladores Phillips® / Phillips® screwdriver	-
	66456, 66457, 66458, 66459, 66472, 66473, 67193	Destornilladores Pozidriv® / Pozidriv® screwdrivers	-
3	66530, 66531, 66532	Destornilladores Robertson / Screwdrivers Robertson	-
11	66487, 66488, 66489, 66490, 66491, 66492, 66493, 66494, 66495, 66496, 66497	Destornilladores Tamper Torx / Screwdrivers Tamper Torx	-
1	65768	Escuadras / Squares	-
7	61583, 61584, 61585, 61586, 61587, 61588, 61589	Extractores de tornillos / Screw extractors	-

PCS.	Composición / Composition / Composition	Descripción / Description / Description	
1	65361	Flexómetros / Measuring tapes	
6	63429, 63430, 63431, 63432, 63433, 63434	Granetes / Center punches	
5	63714, 63715, 63717, 63718, 63719	Limas / Files	
11	60380, 60381, 60382, 60384, 60385, 60388, 60390, 60391, 67886, 67887, 67888	Llaves acodadas / Double offset ring wrenches	-
1	61110	Llaves ajustables / Adjustable wrenches	
30	58460, 58461, 58462, 58463, 58464, 58465, 58466, 58467, 60340, 60341, 60342, 60343, 60344, 60345, 60346, 60347, 60348, 60349, 60350, 60351, 60352, 60353, 60354, 60355, 60356, 60358, 67878, 67885, 67953, 67954	Llaves combinadas / Combination wrenches	
1	62603	Llaves de carraca reversible / Reversible ratchet handles	1/4"
	62606		1/2"
7	68283, 68284, 68285, 68286, 68287, 68288, 68289	Llaves de gancho / Hook spanners	-
27	57165, 57166, 57167, 57168, 57169, 57170, 63989, 63990, 63991, 63992, 63993, 63994, 63995, 63996, 63997, 63998, 67689, 67690, 67691, 67692, 67693, 67694, 67695, 67696, 67697, 67698, 67699	Llaves de vaso / Socket wrenches	1/4"
26	57185, 57186, 57187, 60479, 60480, 60481, 60482, 60483, 60484, 60485, 60486, 60487, 60488, 60489, 60490, 60491, 60492, 60493, 60494, 60495, 60496, 60497, 60498, 67807, 67809, 67811		1/2"
4	57775, 57776, 57777, 57778	Llaves estrella planas / Double ended flat ring spanners	
25	60300, 60301, 60302, 60303, 60304, 60305, 60306, 60307, 60308, 60309, 60310, 60311, 60312, 60313, 60314, 60315, 67931, 67934, 67939, 67940, 67941, 67942, 67943, 67944, 67945	Llaves fijas / Open-end wrenches	
10	58537, 58538, 58539, 58540, 58541, 58542, 58543, 58544, 58545, 58546	Llaves fijas micromecánicas a 15° y 75° / 15° and 75° micromech open end wrenches	
28	65315, 65316, 65317, 65318, 65319, 65320, 65321, 65322, 65323, 65324, 65325, 65326, 65327, 65328, 67671, 68900, 68901, 68902, 68903, 68904, 68905, 68906, 68907, 68908, 68909, 68910, 68911, 68912	Llaves hexagonales / Hexagonal key wrenches	
12	68914, 68915, 68916, 68917, 68918, 68919, 68920, 68921, 68922, 68923, 68924, 68925	Llaves hexagonales bola / Hexagonal key wrenches ball type	-
5	57148, 57149, 57150, 57151, 57152	Llaves media luna / Half moon spanners	
1	61001	Llaves Stillson / Stillson pipe wrenches	
20	56544, 56545, 56546, 56547, 56548, 56549, 56550, 56551, 56552, 56553, 56554, 56556, 56557, 56558, 56559, 56560, 56561, 56562, 56563, 56564	Llaves Tamper Torx / Tamper Torx keys	
1	69504	Magnetizador-desmagnetizador / Magnetizer-demagnetizer	
7	55326, 69521, 69601, 69614, 69620, 69681, 69701	Martillos / Hammers	
	65158	Nivel magnético torpedo / Torpedo Magnetic level	
1	55265	Punta portavasos / Socket holder bit	1/4"
	61695	Puntas adaptadoras para vasos / Adapter bits for sockets	1/2"
	61697		
64	53000, 53001, 53002, 53003, 53004, 53005, 53006, 53007, 53008, 53009, 53010, 53011, 53015, 53016, 53017, 53019, 53020, 53021, 53023, 53024, 53025, 53027, 53028, 53029, 53030, 53031, 53032, 53034, 53035, 53036, 53037, 53038, 53039, 53051, 53052, 53053, 53054, 53055, 53056, 53057, 53058, 53059, 53060, 55670, 55671, 55672, 55673, 55674, 55675, 55676, 55677, 55678, 55679, 58900, 66733, 66734, 66735, 66736, 66737, 66738, 66739, 66740, 66741, 66742		1/4"
10	55684, 56985, 56986, 56987, 56988, 56989, 56990, 56991, 56992, 56993	Puntas atornilladoras con vaso / Socket bits	3/8"
64	53105, 53107, 53108, 53109, 53110, 53111, 53112, 53113, 53114, 53115, 53116, 53117, 53118, 53119, 53120, 53121, 53122, 53123, 53124, 53125, 53127, 53128, 53129, 53131, 53132, 53133, 53134, 53136, 53137, 53138, 53139, 53149, 53150, 53151, 53152, 53153, 53154, 53155, 53156, 53157, 53158, 53159, 55688, 55689, 55690, 55691, 55692, 55693, 55695, 55696, 56896, 56897, 66801, 66802, 66803, 66804, 66805, 66806, 66820, 66821, 66822, 66823, 66824, 66825, 66826, 66827, 66828, 66829		1/2"
1	65783	Punzón / Awl	
	65831	Reglas / Rulers	-
2	62177, 62795	Tenazas / Pincers	
1	65846	Vaso adaptador para puntas / Square drive bit retainer	1/4"

- 428 PCS.
- MM / INCH



COD.	PCS.		Medidas en / Sizes in / Mesures en		 Kg
68962	-	-	-	-	110
68963	428	51039	mm/inch	-	160
55766	-	50954 (2)	-	●	521



PCS.	Composición / Composition / Composition	Descripción / Description / Description	
20	62214, 62215, 62216, 62217, 62218, 62219, 62220, 62221, 62222, 62223, 62224, 62225, 62226, 62227, 62228, 62229, 62180, 62181, 62182, 62183	Alicates Circlips / Circlips pliers	-
27	66400, 66401, 66403, 66405, 66407, 66408, 66409, 66410, 76620, 76621, 76622, 76624, 76625, 76626, 76627, 66438, 66439, 66440, 66441, 66442, 76629, 76630, 66456, 66457, 66458, 66459, 66460	Destornilladores mecánicos, electricistas, Phillips®, Pozidriv® / Slotted, electrician, Phillips®, Pozidriv® screwdrivers	-
26	61725, 61726, 61727, 61728, 61729, 61730, 61731, 61732, 61733, 61734, 61735, 61736, 61737, 61738, 61739, 61740, 61741, 61742, 61743, 61744, 61745, 61746, 61747, 61748, 61749, 61750	Llaves combinadas / Combination wrenches	mm
17	60340, 60341, 60342, 60343, 60344, 60345, 60346, 60347, 60348, 60349, 60350, 60351, 60352, 60353, 60354, 60355, 60356	Llaves combinadas / Combination wrenches	inch
12	61701, 61702, 61703, 61704, 61705, 61706, 61707, 61708, 61709, 61710, 61711, 61713	Llaves fijas / Open-end wrenches	mm
	60300, 60301, 60302, 60303, 60304, 60306, 60309, 60310, 60311, 60312, 60313, 60314	Llaves fijas / Open-end wrenches	inch
	61775, 61776, 61777, 61778, 61779, 61780, 61781, 61782, 61783, 61784, 61785, 61787	Llaves acodadas / Double offset ring wrenches	inch
25	61960	Juego / Set	1/2", mm, 26 pcs
	61963	Juego / Set	1/2", inch, 26 pcs
26	61870, 61871, 61872, 61873, 61874, 61875, 61876, 61877, 61878, 61879, 61880, 61881, 61882, 61883, 61884, 61885, 61886, 61887, 61888, 61889, 61890, 61891, 61892, 61893, 61894, 61895	Llaves de pipa / Angled sockets	-
23	65302, 65303, 65304, 65305, 65306, 65307, 65308, 65309, 65310, 65311, 65312, 65313, 65314, 61501, 61502, 61503, 61504, 61505, 61506, 61507, 61508, 61509, 61510	Llaves hexagonales / Hexagonal keys	mm
15	65315, 65316, 65317, 65318, 65319, 65320, 65321, 65322, 65323, 65324, 65325, 65326, 65327, 65328, 65329	Llaves hexagonales / Hexagonal keys	inch
7	63401, 63402, 63403, 63404, 63405, 63406, 63407	Botadores octogonales / Octagonal punches	-
6	63435, 63436, 63437, 63438, 63439, 63440	Granetes hexagonales / Hexagonal center punches	-
3	63178, 63179, 63180	Cortafíos / Chisel	-
10	62331, 62332, 62333, 62339, 62340, 62341, 62342, 62343, 62344, 62349	Alicates / Pliers	-
9	62241, 62242, 62243, 62244, 62245, 62246, 62247, 62248, 62249	Alicates mini / Mini Pliers	-
2	62135, 62134	Tenazas de canal / Box joint pincers	-
1	61112	Llave ajustable / Adjustable wrench	-
2	62587, 62590	Extractores / Gear pullers	-
1	63748	Arco de sierra / Hack Saw	-
	62963	Llave dinamométrica reversible / Reversible torque wrench	1/2", 40-200 nm
7	69619, 69622, 69614, 69750, 69752, 69729, 69521	Martillos / Hammers	-
33	66942	Juego puntas / Bits set	-
1	61016	Llave HD / HD Pipe wrench	12"
3	62177, 62178, 62172	Tenazas Grip / Grip pincers	-
6	63498, 63534, 63570, 63606, 63642, 63678	Limas / Files	-
1	62233	Tijera de chapa / Tin snip	-
	69534	Tijera electricista / Electrician's scissors	-
	65479	Calibre / Caliper	-
3	69570, 69572, 69575	Sargentos G / G Clamps	-
1	65155	Nivel trapezoidal profesional / Professional bridge type spirit level	400 mm
	66731	Destornillador portapuntas magnético / Screwdriver magnetic bitholder	-
10	60693	Juego de vasos impacto / Impact socket sets	mm
11	61267	Juego de vasos impacto / Impact socket sets	inch
1	62124	Tenaza rusa / Tower pincer	9", 10"
2	62438, 62440	Tenaza carpintero / Carpenter pincer	-
4	69529	Set 4 pinzas / Set 4 tweezers	-
1	62493	Alicate de terminales / Crimping pliers	-
12	66846, 66848, 66849, 66850, 66851, 66852, 66853, 66854, 57684, 57685, 66864, 66865	Juego destornilladores Microtronic / Microtronic screwdriver set	-
1	69504	Magnetizador-desmagnetizador / Magnetizer-demagnetizer	-
	65362	Flexómetros / Measuring tape	3m/10'
6	63714, 63715, 63716, 63717, 63718, 63719	Limas de aguja / Needle files	-
	65595	Recogedor telescópico / Telescopic joing pick up	-
	65586	Espejo articulado / Joint telescopic mirror	-
1	65774	Regla / Ruler	300 mm
	63119	Cortatubos cobre / Cooper tube cutter	42 mm
	63376	Rasqueta / Scraper	-
7	63208	Cepillos / Brushes	-
	68172	Set curvatubos carraca / Ratchet tube bender set	mm
	68001	Abocinador / Pulg flaring tool	inch
1	63172	Cortatubos acero / Steel tube cutter	2"
	63205	Cortatubos plástico Piraina / Piraina plastic pipe cutter	-
	62200	Cortavarillas / Bolt cutters	8"
9	69501	Cutter	-
	64615	Set sierra de coronas / Bimetal hole saws set	-
1	66073	Tester	-

■ ≈ 400 PCS.

■ MM

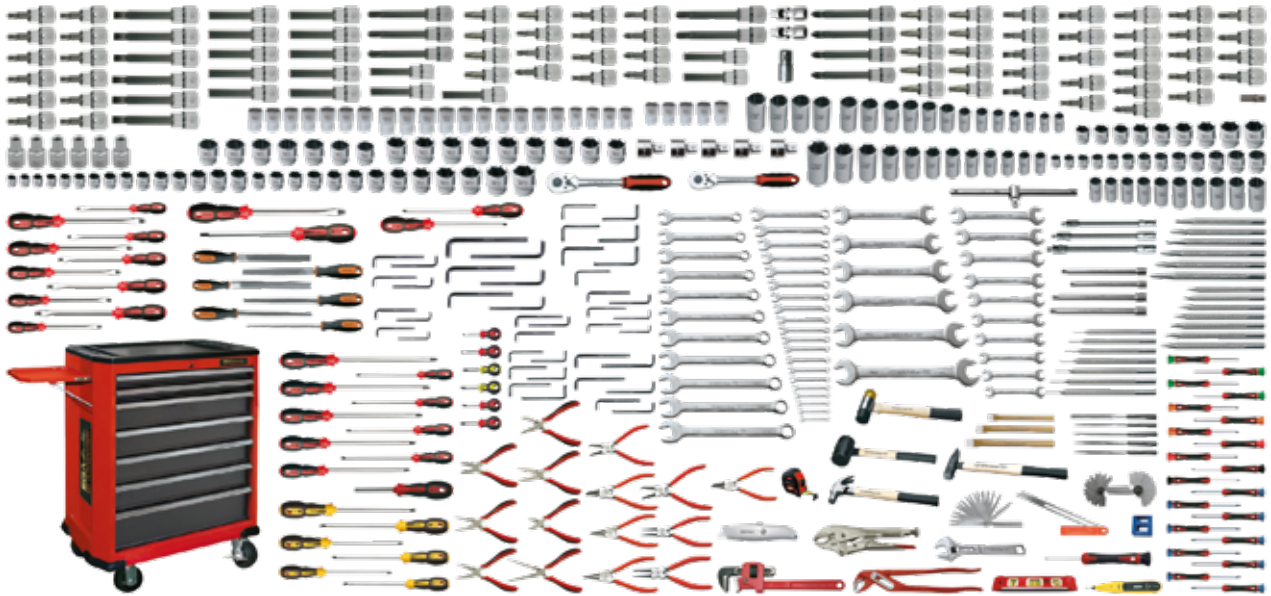

COD.	PCS.		Medidas en / Sizes in / Mesures en		
51707		-			39
51708	413	51039	mm	-	110
51709		50954		●	150

PCS.	Composición / Composition / Composition	Descripción / Description / Description	
1	65880		1/4"
2	65881, 65884	Adaptador para llaves de vaso / Adapter for socket wrenches	3/8"
	65882, 65885		1/2"
4	61442, 61443, 61444, 61445		1/4"
2	61455, 61458	Alargaderas / Extensions	1/2"
4	62331, 62339, 62341, 62343	Alicates / Pliers	
8	62180, 62181, 62182, 62183, 62216, 62220, 62224, 62228	Alicates Circlips / Circlips pliers	-
4	62241, 62242, 62246, 62247	Alicates mini / Mini Pliers	
1	61435	Articulación universal / Universal joint	1/4"
	61437		1/2"
14	63387, 63388, 63389, 63390, 63391, 63392, 63393, 63408, 63409, 63410, 63411, 63412, 63413, 63414	Botadores / Punches	
1	66074	Buscapolos / Voltage tester	-
3	62847, 62849, 62853	Cinceles / Chisels	
1	69501	Cortadores / Cutters	
	66732	Destornillador portavasos / Socket holder	1/4"
4	66525, 66526, 66527, 66529	Destornilladores carroceros / Stubby screwdrivers	
10	66411, 66412, 66420, 66421, 66422, 66423, 66424, 66425, 66426, 66428	Destornilladores electricista / Electrician screwdrivers	
11	66399, 66400, 66401, 66402, 66403, 66404, 66405, 66406, 66407, 66408, 66448	Destornilladores mecánicos / Slotted screwdrivers	
20	57684, 66846, 66847, 66848, 66849, 66850, 66851, 66852, 66853, 66854, 57685, 66864, 66865, 66866, 66867, 66868, 66869, 66870, 66871, 66872	Destornilladores Microtronic / Microtronic screwdrivers	
	66437, 66438, 66439, 66440, 66441, 66443, 67192	Destornilladores Phillips® / Phillips® screwdriver	
7	66456, 66457, 66458, 66459, 66472, 66473, 67193	Destornilladores Pozidriv® / Pozidriv® screwdrivers	
2	66531, 66532	Destornilladores Robertson / Screwdrivers Robertson	-
	66492	Destornilladores Tamper Torx / Screwdrivers Tamper Torx	
1	65768	Escuadras / Squares	
	65171	Flexómetros / Measuring tapes	
2	65559, 65571	Galgas / Gauges	
6	63429, 63430, 63431, 63432, 63433, 63434	Granetes / Center punches	
	63692, 63714, 63715, 63717, 63718, 63719	Limas / Files	
1	61112	Llaves ajustables / Adjustable wrenches	

PCS.	Composición / Composition / Composition	Descripción / Description / Description	
31	61725, 61726, 61727, 61728, 61729, 61730, 61731, 61732, 61733, 61734, 61735, 61736, 61737, 61738, 61739, 61740, 61741, 61742, 61743, 61744, 61745, 61746, 61747, 61748, 61749, 61750, 63965, 63966, 63967, 67880, 67881	Llaves combinadas / Combination wrenches	-
1	62603	Llaves de carraca reversible / Reversible ratchet handles	1/4"
	62606		1/2"
35	55813, 55814, 56015, 56017, 56018, 56019, 56020, 56021, 56023, 56024, 56025, 56026, 56027, 63977, 63978, 63979, 63980, 63981, 63982, 63983, 63984, 63985, 63986, 63987, 67660, 67661, 67662, 67663, 67664, 67665, 67666, 67667, 67668, 67669, 67670		1/4"
56	55795, 55796, 55797, 55798, 55799, 55800, 55801, 55802, 55803, 55804, 55811, 57179, 57180, 57181, 57182, 57183, 57184, 61380, 61381, 61382, 61383, 61384, 61385, 61386, 61387, 61388, 61389, 61390, 61391, 61392, 61393, 61394, 61395, 61396, 61397, 61398, 61399, 61400, 61401, 61402, 67780, 67781, 67782, 67783, 67784, 67785, 67786, 67787, 67788, 67789, 67791, 67792, 67793, 67794, 67795, 67796	Llaves de vaso / Socket wrenches	1/2"
14	61701, 61702, 61703, 61704, 61705, 61706, 61707, 61708, 61709, 61710, 61711, 61712, 61713, 67917	Llaves fijas / Open-end wrenches	
29	61501, 61502, 61503, 61504, 61505, 61506, 61517, 61518, 61519, 61525, 61526, 61621, 61622, 61623, 61624, 65302, 65303, 65304, 65306, 65307, 65308, 65330, 65331, 65332, 65519, 65955, 65956, 67493, 67494	Llaves hexagonales / Hexagonal key wrenches	-
1	61001	Llaves Stillson / Stillson pipe wrenches	
11	56544, 56545, 56546, 56547, 56548, 56549, 56550, 56551, 56552, 56553, 56554	Llaves Tamper Torx / Tamper Torx keys	
1	69504	Magnetizador-desmagnetizador / Magnetizer-demagnetizer	
	61438	Mango correrizo en T / Sliding "T" handle	1/4"
4	55326, 69521, 69614, 69622	Martillos / Hammers	
1	65158	Nivel magnético torpedo / Torpedo Magnetic level	-
	55265	Punta portavasos / Socket holder bit	
53	53000, 53001, 53002, 53003, 53004, 53005, 53006, 53007, 53008, 53009, 53010, 53011, 53013, 53015, 53016, 53017, 53019, 53020, 53021, 53023, 53024, 53025, 53041, 53042, 53043, 53044, 53045, 53046, 53047, 53048, 53049, 53050, 55697, 55698, 55699, 55700, 58900, 66733, 66734, 66735, 66736, 66737, 66738, 66739, 66740, 66741, 66742, 66743, 66744, 66745, 66746, 66747, 67164	Puntas atornilladoras con vaso / Socket bits	1/4"
42	53105, 53107, 53108, 53109, 53110, 53115, 53116, 53117, 53118, 53119, 53120, 53127, 53128, 53129, 53131, 53132, 53133, 53136, 53137, 53138, 55704, 55705, 55708, 66801, 66802, 66804, 66805, 66806, 66807, 66808, 66809, 66810, 66811, 66812, 66813, 66814, 66815, 66816, 66817, 66818, 67213, 67214		1/2"
2	62177, 62795	Tenazas / Pincers	-
1	65846	Vaso adaptador para puntas / Square drive bit retainer	1/4"

### INCH

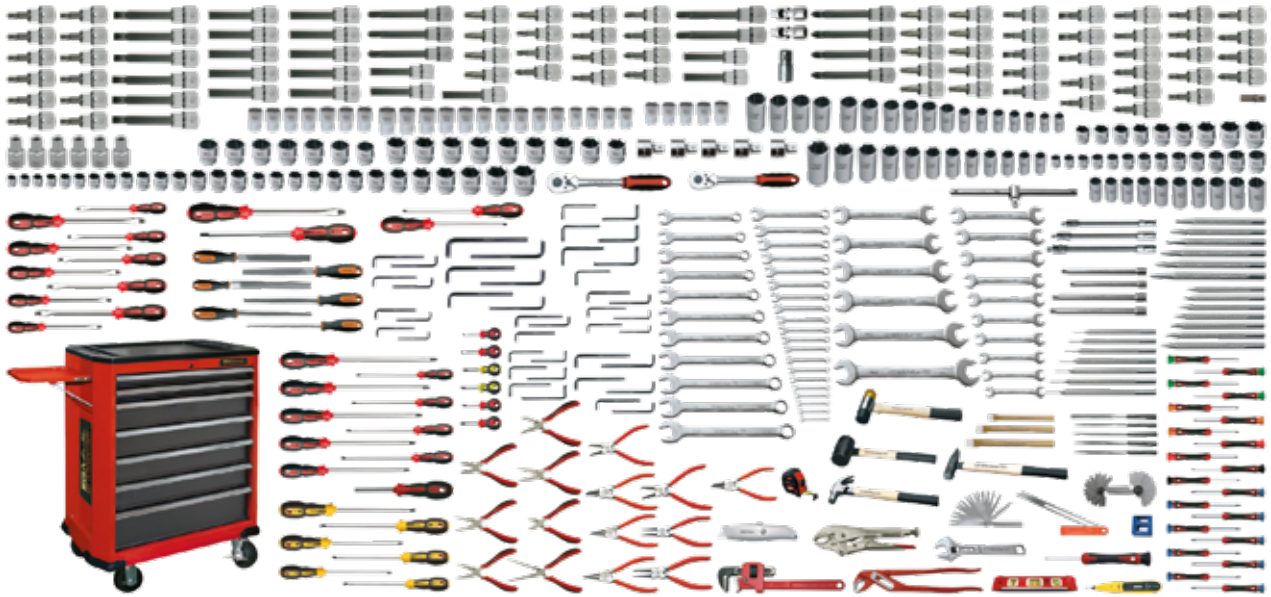

COD.	PCS.	Medidas en / Sizes in / Mesures en	Kg
51710	-	-	37
51711	414	51039	105
51712	-	50954	150

PCS.	Composición / Composition / Composition	Descripción / Description / Description	
1	65880		1/4"
2	65881, 65884	Adaptador para llaves de vaso / Adapter for socket wrenches	3/8"
	65882, 65885		1/2"
1	65603	Agujas de trazar / Scribers	-
3	61442, 61444, 61445	Alargaderas / Extensions	1/4"
	61453, 61455, 61458		1/2"
4	62331, 62339, 62341, 62343	Alicates / Pliers	
8	62180, 62181, 62182, 62183, 62216, 62220, 62224, 62228	Alicates Circlips / Circlips pliers	-
6	62241, 62242, 62243, 62245, 62246, 62247	Alicates mini / Mini Pliers	
1	61435	Articulación universal / Universal joint	1/4"
	61437		1/2"
14	63387, 63388, 63389, 63390, 63391, 63392, 63393, 63408, 63409, 63410, 63411, 63412, 63413, 63414	Botadores / Punches	
1	66074	Buscapolos / Voltage tester	-
2	62847, 62849	Cinceles / Chisels	
1	69501	Cortadores / Cutters	
	66732	Destornillador portavasos / Socket holder	1/4"
3	55371, 66526, 66527	Destornilladores carroceros / Stubby screwdrivers	
8	55352, 55354, 55355, 55357, 55358, 55359, 55360, 55361	Destornilladores electricista / Electrician screwdrivers	
9	55328, 55330, 55331, 55332, 55333, 55334, 55335, 55337, 55338	Destornilladores mecánicos / Slotted screwdrivers	
19	55449, 55450, 55451, 55452, 55453, 55457, 55458, 66850, 66851, 66852, 66853, 66854, 66866, 66867, 66868, 66869, 66870, 66871, 66872	Destornilladores Microtronic / Microtronic screwdrivers	
7	66437, 66438, 66439, 66440, 66441, 66443, 67192	Destornilladores Phillips® / Phillips® screwdriver	
	66456, 66457, 66458, 66459, 66472, 66473, 67193	Destornilladores Pozidriv® / Pozidriv® screwdrivers	
3	66530, 66531, 66532	Destornilladores Robertson / Screwdrivers Robertson	
11	66487, 66488, 66489, 66490, 66491, 66492, 66493, 66494, 66495, 66496, 66497	Destornilladores Tamper Torx / Screwdrivers Tamper Torx	
1	65768	Escuadras / Squares	
	65361	Flexómetros / Measuring tapes	
6	63429, 63430, 63431, 63432, 63433, 63434	Granetes / Center punches	
5	63714, 63715, 63717, 63718, 63719	Limas / Files	
1	61110	Llaves ajustables / Adjustable wrenches	
24	58460, 58461, 58462, 58463, 58464, 60340, 60341, 60342, 60343, 60344, 60345, 60346, 60347, 60348, 60349, 60351, 60352, 60353, 60354, 60356, 67878, 67885, 67953, 67954	Llaves combinadas / Combination wrenches	
1	62603	Llaves de carraca reversible / Reversible ratchet handles	1/4"



PCS.	Composición / Composition / Composition	Descripción / Description / Description	
1	62606	Llaves de carraca reversible / Reversible ratchet handles	1/2"
21	63989, 63990, 63991, 63992, 63993, 63994, 63995, 63996, 63997, 63998, 67689, 67690, 67691, 67692, 67693, 67694, 67695, 67696, 67697, 67698, 67699	Llaves de vaso / Socket wrenches	1/4"
23	60479, 60480, 60481, 60482, 60483, 60484, 60485, 60486, 60487, 60488, 60489, 60490, 60491, 60492, 60493, 60494, 60495, 60496, 60497, 60498, 67807, 67809, 67811	Llaves hexagonales / Hexagonal key wrenches	1/2"
25	60300, 60301, 60302, 60303, 60304, 60305, 60306, 60307, 60308, 60309, 60310, 60311, 60312, 60313, 60314, 60315, 67931, 67934, 67939, 67940, 67941, 67942, 67943, 67944, 67945	Llaves hexagonales bola / Hexagonal key wrenches ball type	-
28	65315, 65316, 65317, 65318, 65319, 65320, 65321, 65322, 65323, 65324, 65325, 65326, 65327, 65328, 67671, 68900, 68901, 68902, 68903, 68904, 68905, 68906, 68907, 68908, 68909, 68910, 68911, 68912	Llaves Stillson / Stillson pipe wrenches	-
12	68914, 68915, 68916, 68917, 68918, 68919, 68920, 68921, 68922, 68923, 68924, 68925	Llaves Tamper Torx / Tamper Torx keys	-
1	61001	Magnetizador-desmagnetizador / Magnetizer-demagnetizer	-
20	56544, 56545, 56546, 56547, 56548, 56549, 56550, 56551, 56552, 56553, 56554, 56556, 56557, 56558, 56559, 56560, 56561, 56562, 56563, 56564	Martillos / Hammers	-
1	69504	Nivel magnético torpedo / Torpedo Magnetic level	-
4	55326, 69601, 69614, 69620	Punta portavasos / Socket holder bit	1/4"
	65158	Puntas adaptadoras para vasos / Adapter bits for sockets	1/2"
1	55265		
	61695		
	61697		
64	53000, 53001, 53002, 53003, 53004, 53005, 53006, 53007, 53008, 53009, 53010, 53011, 53015, 53016, 53017, 53019, 53020, 53021, 53023, 53024, 53025, 53027, 53028, 53029, 53030, 53031, 53032, 53034, 53035, 53036, 53037, 53038, 53039, 53051, 53052, 53053, 53054, 53055, 53056, 53057, 53058, 53059, 53060, 55670, 55671, 55672, 55673, 55674, 55675, 55676, 55677, 55678, 55679, 58900, 66733, 66734, 66735, 66736, 66737, 66738, 66739, 66740, 66741, 66742	Puntas atornilladoras con vaso / Socket bits	3/8"
7	56985, 56986, 56987, 56988, 56990, 56991, 56992		
41	53105, 53107, 53108, 53109, 53110, 53115, 53116, 53117, 53118, 53119, 53120, 53121, 53122, 53123, 53124, 53125, 53127, 53128, 53129, 53131, 53132, 53133, 53134, 53136, 53137, 53138, 53139, 55688, 55689, 55690, 55691, 55692, 55693, 55695, 55696, 66801, 66802, 66803, 66804, 66805, 66806		1/2"
1	65783	Punzón / Awl	-
	65831	Reglas / Rulers	-
2	62177, 62795	Tenazas / Pincers	-
1	65846	Vaso adaptador para puntas / Square drive bit retainer	1/4"

■ 290 PCS.  
■ MM / INCH





COD.	PCS.		Medidas en / Sizes in / Mesures en		Kg
69774	-	-	-	-	26
69775	290	51075	mm/inch	-	73
69784	-	-	-	-	-

PCS.	Composición / Composition / Composition	Descripción / Description / Description	
3	62214, 62222, 62183	Alicates Circlips / Circlips pliers	
7	62340, 62342, 62344, 62333, 62337, 62346, 62338	Alicates / Pliers	
1	62494	Alicate de terminales / Crimping pliers	-
9	62651, 62653, 62654, 62655, 62656, 62657, 62659, 62660, 62662	Llaves combinadas de carraca / Combination ratchet wrenches	
6	62666, 62667, 62668, 62669, 62671, 62673		
13	60340, 60341, 60342, 60343, 60344, 60345, 60347, 60348, 60349, 60351, 60352, 60353, 60354	Llaves combinadas / Combination wrenches	inch
14	61725, 61726, 61727, 61728, 61729, 61730, 61731, 61732, 61733, 61734, 61735, 61736, 61737, 61738		mm
1	65550	Galgas de espesores / Feeler gauge	
	69501	Cutter	
4	63429, 63431, 63432, 63436	Granetes / Center punches	
1	62828	Extractor / Gear puller	
	62847	Cinzel mecánico / Flat cold chisel	-
7	63408, 63409, 63410, 63411, 63412, 63413, 63414	Botadores cónicos / Taper punch	
	63394, 63395, 63396, 63397, 63398, 63399, 63400	Botadores cilíndricos / Pin punches	
	62707	Tenaza de canal / Box joint	
1	61500	Juego llaves Allen / Allen keys wrenches Set	mm
	61516		inch
	61496	Juego llaves Allen bola / Set of hexagonal key wrenches ball type	mm
	61495		inch
4	66438, 66439, 66440, 66441	Destornilladores Phillips® / Phillips® screwdriver	
3	66402, 66403, 66405	Destornilladores mecánicos / Slotted screwdrivers	
4	66420, 66422, 66423, 66425	Destornilladores electricistas / Electrician screwdrivers	
2	66457, 66458	Destornilladores Pozidriv® / Pozidriv® screwdrivers	
33	66942	Juego puntas / Bits set	-
4	66733, 66734, 66735, 66736	Puntas atornilladoras con vaso planas / Flat socket bits	
3	66737, 66738, 66739	Puntas atornilladoras con vaso Phillips® / Phillips® socket bits	
5	66743, 66744, 66745, 66746, 66747	Puntas atornilladoras con vaso hexagonales / Hexagonal socket bits	
9	66748, 66749, 66750, 66751, 66752, 66753, 66754, 66755, 66756	Puntas atornilladoras con vaso Torx® / Torx® socket bits	
24	61791	Juego vasos / Socket set	mm/inch, 1/4", 24 pcs
42	61792		mm/inch, 3/8", 42 pcs
41	61793		mm/inch, 1/2", 41 pcs

■ 213 PCS.

■ MM / INCH



COD.	PCS.		Medidas en / Sizes in / Mesures en		
59148			-		28
59149	213		51674	mm/inch	70
59150			51025	●	82

PCS.	Composición / Composition / Composition	Descripción / Description / Description	
5	62332, 62338, 62340, 62341, 62343	Alicates / Pliers	
4	62180, 62181, 62182, 62183	Alicates Circlip / Circlip pliers	
1	62091	Alicates tipo Ford	
14	63394, 63395, 63396, 63397, 63398, 63399, 63400, 63422, 63423, 63424, 63425, 63426, 63427, 63428	Botadores / Punches	
1	62871	Buriles planos / Crosscut chisels	
	61578	Cepillo / Brushes	
2	62849, 63472	Cinceles / Chisels	-
1	66070	Destornillador buscapolos / Voltage tester screwdriver	
2	66937, 67190	Destornilladores carroceros / Stubby screwdrivers	
6	66874, 66875, 66877, 66879, 66881, 66882	Destornilladores mecánicos / Slotted screwdrivers	
5	66897, 66898, 66899, 66900, 67131	Destornilladores Phillips® / Phillips® screwdriver	
7	66917, 66919, 66921, 66922, 66923, 66924, 66926	Destornilladores Torx® / Screwdrivers Torx®	
1	65172	Flexómetros / Measuring tapes	
10	61500	Juego llaves hexagonales / Set hexagonal key wrenches	mm
36	58720, 61963	Juego vasos / Socket set	1/2"
62	58691, 58695	Juego Vasos / Socket set	1/4"
5	63537, 63573, 63609, 63645, 63681	Limas / Files	-
12	60380, 60381, 60382, 60383, 60384, 60386, 60389, 60390, 60391, 60392, 60393, 60394	Llaves acodadas / Double offset ring wrenches	
17	60340, 60341, 60342, 60343, 60344, 60345, 60346, 60347, 60348, 60349, 60350, 60351, 60352, 60353, 60354, 60355, 60356	Llaves combinadas / Combination wrenches	inch
12	60300, 60301, 60302, 60303, 60304, 60306, 60309, 60310, 60311, 60312, 60313, 60314	Llaves fijas / Open-end wrenches	
2	55326, 69621	Martillos / Hammers	
1	65388	Navajas / Penknives	
	65588	Recogedor telescópico / Telescopic joint pick up	-
3	62128, 62140, 62172	Tenazas / Pincers	
1	62170	Tijeras / Tin snips	
	69534	Tijeras electricista / Electrician's scissors	

■ 191 PCS.  
■ MM / INCH



COD.	PCS.	Medidas en / Sizes in / Mesures en	Kg
68964		-	39
68965	191	mm/inch	89
55767		●	194

PCS.	Composición / Composition / Composition	Descripción / Description / Description	
16	62214, 62215, 62216, 62217, 62218, 62219, 62220, 62221, 62222, 62223, 62224, 62225, 62226, 62227, 62228, 62229	Alicates Circlips / Circlips pliers	-
18	66400, 66401, 66403, 66407, 66408, 76621, 76622, 76624, 76625, 76626, 66439, 66440, 66441, 76629, 76630, 66457, 66458, 66459	Destornilladores mecánicos, electricistas, Phillips®, Pozidriv® / Slotted, electrician, Phillips®, Pozidriv® screwdrivers	-
12	61725, 61726, 61727, 61728, 61729, 61730, 61731, 61732, 61733, 61734, 61735, 61736 60341, 60342, 60343, 60344, 60345, 60347, 60348, 60349, 60351, 60352, 60353, 60354 61701, 61702, 61703, 61704, 61705, 61706, 61707, 61708	Llaves combinadas / Combination wrenches	mm inch
8	60302, 60303, 60304, 60306, 60309, 60310, 60311, 60312 61775, 61776, 61777, 61778, 61779, 61780, 61781, 61782 60382, 60383, 60384, 60385, 60386, 60389, 60390, 60391	Llaves fijas / Open-end wrenches Llaves acodadas / Double offset ring wrenches	mm inch
17	61796 61798	Juego llaves vaso / Socket wrench set	1/2", mm 1/2", inch
10	61503, 61504, 61505, 61506, 61508, 61509, 61510, 65307, 65308, 65310 65318, 65319, 65320, 65321, 65322, 65323, 65324, 65325, 65326, 65327	Llaves hexagonales / Hexagonal keys	mm inch
5	63402, 63403, 63404, 63405, 63406	Botadores / Punches	
2	63178, 63179,	Cortafíos / Chisel	
4	62340, 62343, 62344, 62349	Alicates / Pliers	
1	62135 61112	Tenazas de canal / Box joint pincers Llave ajustable / Adjustable wrench	-
2	62587, 62590	Extractores / Gear pullers	
1	63748	Arco de sierra / Hack Saw	
4	69619, 69622, 69614, 69750	Martillos / Hammers	
1	61016	Llave HD / HD Pipe wrench	12"
3	62177, 62178, 62172	Tenazas Grip / Grip pincers	
6	63498, 63534, 63570, 63606, 63642, 63678	Limas / Files	
	62233	Tijera de chapa / Tin snip	
	69534	Tijera electricista / Electrician's scissors	
1	65479 69572 62124	Calibre / Caliper Sargentos G / G Clamps Tenaza rusa / Tower pincer	10"
2	62438, 62440	Tenaza carpintero / Carpenter pincer	
4	69529 62493 65362	Set 4 pinzas / Set 4 tweezers Alicate de terminales / Crimping pliers Flexómetro / Measuring tape	- 3 m/10'
1	65595 63119 69501 66073	Recogedor telescópico / Telescopic joing pick up Cortatubos cobre / Cooper tube cutter Cutter Tester	- 42 mm -



■ 181 PCS.

■ INCH



COD.	PCS.	Medidas en / Sizes in / Mesures en	Kg
59151	-	-	45
59152	181	inch	143
59153	50950	-	145

  

PCS.	Composición / Composition / Composition	Descripción / Description / Description	
9	62299, 62300, 62337, 62338, 62346, 62349, 62495, 62498, 62500	Alicates / Pliers	
4	62214, 62218, 62222, 62226	Alicates Circlips / Circlips pliers	
2	63299, 63742	Arcos de sierra / Hack saws	
8	63394, 63395, 126792, 63397, 63398, 63399, 63400, 63416	Botadores / Punches	
1	62871	Buriles planos / Crosscut chisels	
2	62847, 62848	Cinceles / Chisels	
1	63874	Cortadores / Cutters	
9	55373, 55374, 55375, 55376, 55378, 55379, 55380, 55382, 55383	Destornilladores de vaso / Socket screwdrivers	
7	66571, 66572, 66573, 66574, 66575, 66576, 66577	Destornilladores T-Mastertork / T-Mastertork screwdrivers	
	67021	Espátulas / Scrapers	
1	65357	Flexómetros / Measuring tapes	
	63436	Granetes / Center punches	
5	61591	Juego de extractores de tornillos / Set of screw extractors	
4	67206	Juego de palancas boca curva / Set of pry bars	
1	61495	Juego llaves hexagonales bola / Set hexagonal key wrenches ball type	inch
25	61963		3/8"
14	61862	Juego vasos / Socket set	1/2"
16	61962		3/4"
1	62951	Llave dinamoétrica reversible / Reversible torque wrench	1/4", 2,5-12 Nm
2	61111, 61112	Llaves ajustables / Adjustable wrenches	-
15	60342, 60343, 60344, 60345, 60347, 60348, 60349, 60351, 60352, 60353, 60354, 60355, 60356, 60357, 60358	Llaves combinadas / Combination wrenches	inch
6	62666, 62667, 62668, 62669, 62672, 62673	Llaves combinadas de carraca / Combination ratchet wrenches	
1	62603	Llaves de carraca reversible / Reversible ratchet handles	
11	60420, 60421, 60422, 60423, 60424, 60425, 60426, 60427, 60428, 60429, 60430	Llaves de vaso / Socket wrenches	1/4"
12	60300, 60301, 60302, 60303, 60304, 60306, 60309, 60310, 60311, 60312, 60313, 60314	Llaves fijas / Open-end wrenches	inch
2	61015, 61017	Llaves heavy duty / Heavy duty wrenches	
1	61405	Llaves para tubo Mastergrip / Mastergrip pipe wrenches	
	57581	Llaves refinera para tubo y válvulas / Refinery pipe and valve wrenches	-
3	69614, 69750, 72766	Martillos / Hammers	
1	65388	Navajas / Penknives	
9	55682, 55683, 55684, 55685, 55686, 55687, 56990, 56991, 56992	Puntas atornilladoras con vaso / Socket bits	3/8"
1	69572	Sargentos / Clamps	
	62172	Tenazas / Pincers	-
2	62159, 62234	Tijeras / Tin snips	

■ 171 PCS.

■ MM





COD.	PCS.		Medidas en / Sizes in / Mesures en		Kg
55793		-			22
55794	171	51025	mm	-	72
69989					

PCS.	Composición / Composition / Composition	Descripción / Description / Description
12	66400, 66401, 66403, 66405, 66439, 66440, 66478, 66479, 66480, 66481, 66483, 66484	Destornilladores Mastertork: mecánico, Phillips®, Torx® / Screwdrivers Mastertork: slotted, Phillips®, Torx®
3	62332, 62339, 62343	Alicates Titacrom®: universal, telefonista y corte diagonal / Pliers Titacrom®: combination, long nose, diagonal plier
26	61725, 61726, 61727, 61728, 61729, 61730, 61731, 61732, 61733, 61734, 61735, 61736, 61737, 61738, 61739, 61740, 61741, 61742, 61743, 61744, 61745, 61746, 61747, 61748, 61749, 61750	Llaves combinadas cromado aeroespacial / Aerospaceal chrome plating combination wrenches
46	61800, 61801, 61802, 61803, 61804, 61805, 61806, 61807, 61808, 61809, 61810, 61811, 61812, 61813, 61814, 61815, 61816, 61817, 61818, 61819, 61822, 61823, 61311, 61312, 61313, 61314, 61315, 61316, 61317, 61318, 61319, 61320, 61321, 65044, 65045, 65046, 65047, 65048, 65049, 65050, 65051, 65052, 65053, 65054, 65055, 65056	Llaves de vaso / Socket wrenches
2	61438, 61440	Mango correrizo en T / Sliding "T" handle
4	61442, 61444, 61455, 61458	Alargadera / Extension
2	62603, 61431	Llave de carraca reversible / Reversible ratchet handle
	61435, 61437	Articulación universal / Universal joint
1	66731	Destornillador portapuntas magnético / Screwdriver magnetic bitholder
15	58230, 58231, 58232, 58242, 58243, 58247, 58248, 58253, 58254, 58255, 58164, 58165, 58271, 58155, 58272	Puntas de destornillador Masterbit / Masterbit bits
3	61501, 61502, 61503	Llaves hexagonales / Hexagonal keys
1	66264	Adaptador portapuntas magnético / Magnetic bit holder
13	66733, 66734, 66735, 66737, 66738, 66740, 66741, 66748, 66750, 66751, 66752, 66753, 66755	Puntas atornilladoras con vaso / Socket bits
1	63742	Arco de sierra / Hack Saw
3	62169, 62170, 62171	Tijera articulada / Aviation tin snip
1	63876	Cortador / Cutter
3	63178, 63179, 63180	Cortafíos / Chisel
6	63394, 63395, 63396, 63397, 63398, 63399	Botador / Pin punch
1	69621	Martillo alemán / German type machinist's hammer
	55326	Maceta de nylon / Nylon hammer
11	63498, 63570, 63606, 63642, 63678, 63714, 63715, 63716, 63717, 63718, 63719	Limas / Files
4	62180, 62181, 62182, 62183	Alicates Circlips / Circlips pliers
	62172	Tenaza Grip / Grip plier
	61944	Llave ajustable / Adjustable wrench
	62707	Tenaza de canal / Box joint
	69534	Tijera electricista / Electrician's scissors
1	62494	Tenaza para engastar / Crimping plier
	62151	Tenaza cortacables / Cable cutters
	65167	Flexómetro / Measuring tape
	65293	Nivel trapezoidal profesional / Professional bridge type spirit level
	65480	Calibre / Caliper
	66073	Buscapolos / Voltage tester

■ 110 PCS.

■ INCH



COD.	PCS.		Medidas en / Sizes in / Mesures en	
59145		-		11
59146	110	51674	inch	53
59147			●	56

PCS.	Composición / Composition / Composition	Descripción / Description / Description	
1	65884	Adaptador para llaves de vaso / Adapter for socket wrenches	3/8"
	65603	Agujas de trazar / Scribers	-
2	61442, 61444	Alargaderas / Extensions	1/4"
	61447, 61459		3/8"
	62344, 62499	Alicates / Pliers	-
	62091	Alicates tipo Ford / Slip joint pliers	-
1	61435	Articulación universal / Universal joint	1/4"
	61436		
	61409	Berbiquí / Speeder Handle	3/8"
2	66937, 66938	Destornilladores carroceros / Stubby screwdrivers	
4	66876, 66878, 66880, 66882	Destornilladores mecánicos / Slotted screwdrivers	
	66901	Destornilladores Phillips® / Phillips® screwdriver	-
1	66843	Destornilladores portapuntas / Bitholder screwdrivers	
	65570	Galgas / Gauges	
10	61495	Juego llaves hexagonales bola / Set hexagonal key wrenches ball type	
2	63289, 63290	Llave de carraca doble Mastergear / Mastergear double ratchet wrench	inch
13	60340, 60341, 60342, 60343, 60344, 60345, 60347, 60348, 60349, 60351, 60352, 60353, 67878	Llaves combinadas / Combination wrenches	
1	62603	Llaves de carraca reversible / Reversible ratchet handles	1/4"
	62604		3/8"
20	63989, 63990, 63991, 63992, 63993, 63994, 63995, 63996, 63997, 63998, 67690, 67691, 67692, 67693, 67694, 67695, 67696, 67697, 67698, 67699	Llaves de vaso / Socket wrenches	1/4"
24	60439, 60440, 60442, 60443, 60444, 60445, 60447, 60448, 60449, 60450, 60451, 60452, 67750, 67751, 67752, 67753, 67754, 67755, 67757, 67758, 67759, 67760, 67761, 67762	Llaves de vaso articuladas / Universal sockets	3/8"
5	57288, 57289, 57290, 57291, 57292	Llaves fijas micromecánicas a 15° y 75° / 15° and 75° micromech open end wrenches	inch
6	58544, 58545, 58546, 58547, 58548, 58549	Mango articulado / Swivel handle	
1	65875	Mango correrizo en T / Sliding "T" handle	3/8"
	61439		
2	69614, 69750	Martillos / Hammers	-
1	55685	Puntas atornilladoras con vaso / Socket bits	3/8"
2	62106, 62178	Tenazas / Pincers	-

■ 109 PCS.

■ INCH



COD.	PCS.		Medidas en / Sizes in / Mesures en		
59154	109	58609	inch	●	30

PCS.	Composición / Composition / Composition	Descripción / Description / Description	
1	65884	Adaptador para llaves de vaso / Adapter for socket wrenches	3/8"
	65603	Agujas de trazar / Scribers	-
	61442, 61444		1/4"
2	61447, 61459	Alargaderas / Extensions	3/8"
	62344, 62499	Alicates / Pliers	-
	62091	Alicates tipo Ford / Slip joint pliers	-
1	61435	Articulación universal / Universal joint	1/4"
	61436		-
	61409	Berbiquí / Speeder Handle	3/8"
2	66937, 66938	Destornilladores carroceros / Stubby screwdrivers	-
4	66876, 66878, 66880, 66882	Destornilladores mecánicos / Slotted screwdrivers	-
	66901	Destornilladores Phillips® / Phillips® screwdriver	-
1	66843	Destornilladores portapuntas / Bit holder screwdrivers	-
	65570	Galgas / Gauges	-
10	61495	Juego llaves hexagonales bola / Set hexagonal key wrenches ball type	-
1	63290	Llave de carraca doble Mastergear / Mastergear double ratchet wrench	inch
13	60340, 60341, 60342, 60343, 60344, 60345, 60347, 60348, 60349, 60351, 60352, 60353, 67878	Llaves combinadas / Combination wrenches	-
1	62603	Llaves de carraca reversible / Reversible ratchet handles	1/4"
	62604		3/8"
20	63989, 63990, 63991, 63992, 63993, 63994, 63995, 63996, 63997, 63998, 67690, 67691, 67692, 67693, 67694, 67695, 67696, 67697, 67698, 67699	Llaves de vaso / Socket wrenches	1/4"
24	60439, 60440, 60442, 60443, 60444, 60445, 60447, 60448, 60449, 60450, 60451, 60452, 67750, 67751, 67752, 67753, 67754, 67755, 67757, 67758, 67759, 67760, 67761, 67762		3/8"
5	57288, 57289, 57290, 57291, 57292	Llaves de vaso articuladas / Universal sockets	1/4"
6	58544, 58545, 58546, 58547, 58548, 58549	Llaves fijas micromecánicas a 15° y 75° / 15° and 75° micromech open end wrenches	inch
1	65875	Mango articulado / Swivel handle	-
	61439	Mango correrizo en T / Sliding "T" handle	3/8"
2	69614, 69750	Martillos / Hammers	-
1	55685	Puntas atornilladoras con vaso / Socket bits	3/8"
2	62106, 62178	Tenazas / Pincers	-



**JUEGOS MANTENIMIENTO INDUSTRIAL / INDUSTRIAL MAINTENANCE SETS / SETS DE MAINTENANCE INDUSTRIELLE / INDUSTRIELLE INSTANDHALTUNG SETS / KIT MANUTENZIONE INDUSTRIALE / JOGOS DE MANUTENÇÃO INDUSTRIAL / ИНДУСТРИАЛЬНЫЕ НАБОРЫ**
■ 299 PCS.

■ MM

COD.	PCS.	Medidas en / Sizes in / Mesures en	Kg
68966	-	-	67
68967	299	51039 mm	117
55768	-	57060	323

PCS.	Composición / Composition / Composition	Descripción / Description / Description	
20	62214, 62215, 62216, 62217, 62218, 62219, 62220, 62221, 62222, 62223, 62224, 62225, 62226, 62227, 62228, 62229, 62180, 62181, 62182, 62183	Alicates Circlips / Circlips pliers	-
27	66400, 66401, 66403, 66405, 66407, 66408, 66409, 66410, 76620, 76621, 76622, 76624, 76625, 76626, 76627, 66438, 66439, 66440, 66441, 66442, 76629, 76630, 66456, 66457, 66458, 66459, 66460	Destornilladores mecánicos, electricistas, Phillips®, Pozidriv® / Slotted, electrician, Phillips®, Pozidriv® screwdrivers	-
26	61725, 61726, 61727, 61728, 61729, 61730, 61731, 61732, 61733, 61734, 61735, 61736, 61737, 61738, 61739, 61740, 61741, 61742, 61743, 61744, 61745, 61746, 61747, 61748, 61749, 61750	Llaves combinadas / Combination wrenches	mm
12	61701, 61702, 61703, 61704, 61705, 61706, 61707, 61708, 61709, 61710, 61711, 61713	Llaves fijas / Open-end wrenches	
	61775, 61776, 61777, 61778, 61779, 61780, 61781, 61782, 61783, 61784, 61785, 61787	Llaves acodadas / Double offset ring wrenches	
25	61960	Juego / Set	1/2", mm, 26 pcs
12	61872, 61874, 61875, 61877, 61878, 61881, 61883, 61886, 61888, 61891, 61894, 61895	Llaves de pipa / Angled sockets	mm
14	61501, 61502, 61503, 61504, 61505, 61506, 61508, 61509, 61510, 65307, 65308, 65310, 65311, 65313	Llaves hexagonales / Hexagonal keys	
7	63401, 63402, 63403, 63404, 63405, 63406, 63407	Botadores / Punches	
2	63178, 63179	Cortafíos / Chisel	
10	62331, 62332, 62333, 62339, 62340, 62341, 62342, 62343, 62344, 62349	Alicates / Pliers	
2	62135, 62134	Tenazas de canal / Box joint pincers	-
1	61112	Llave ajustable / Adjustable wrench	
2	62587, 62590	Extractores / Gear pullers	
1	63748	Arco de sierra / Hack Saw	
29	61958	Juego vasos / Socket set	1/4"
1	62963	Llave dinamométrica reversible / Reversible torque wrench	1/2", 40-200 nm
4	69619, 69622, 69614, 69750	Martillos / Hammers	-
33	66942	Juego puntas / Bits set	-
1	61016	Llave HD / HD Pipe wrench	12"
3	62177, 62178, 62172	Tenazas Grip / Grip pincers	
6	63498, 63534, 63570, 63606, 63642, 63678	Limas / Files	
	62233	Tijera de chapa / Tin snip	-
1	69534	Tijera electricista / Electrician's scissors	
	65479	Calibre / Caliper	
2	69571, 69574	Sargentos G / G Clamps	
1	65155	Nivel trapezoidal profesional / Professional bridge type spirit level	400 mm
	66731	Destornillador portapuntas magnético / Screwdriver magnetic bitholder	-
10	60693	Juego de vasos impacto / Impact socket sets	-
1	62124	Tenaza rusa / Tower pincer	10"
4	69529	Set 4 pinzas / Set 4 tweezers	
1	62493	Alicate de terminales / Crimping pliers	-
11	65089, 65090, 65091, 65092, 65093, 65095, 65096, 65098, 65099, 65100, 65102	Llaves de carraca para racores	
6	66999	Juego destornilladores Microtronic / Microtronic screwdriver set	
1	65172	Flexómetro Rallye II / Rallye II Measuring tape	3 m/16 mm
6	63714, 63715, 63716, 63717, 63718, 63719	Limas de aguja / Needle files	
	65595	Recogedor telescópico / Telescopic joing pick up	-
1	65586	Espejo articulado / Joint telescopic mirror	
	65774	Regla / Ruler	300 mm

■ 286 PCS.

■ INCH



COD.	PCS.		Medidas en / Sizes in / Mesures en	
68968		-		55
68969	286	51039	inch	105
55769		51117		311
PCS.	Composición / Composition / Composition		Descripción / Description / Description	
20	62214, 62215, 62216, 62217, 62218, 62219, 62220, 62221, 62222, 62223, 62224, 62225, 62226, 62227, 62228, 62229, 62180, 62181, 62182, 62183		Alicates Circlips / Circlips pliers	
27	66400, 66401, 66403, 66405, 66407, 66408, 66409, 66410, 76620, 76621, 76622, 76624, 76625, 76626, 76627, 66438, 66439, 66440, 66441, 66442, 76629, 76630, 66456, 66457, 66458, 66459, 66460		Destornilladores mecánicos, electricistas, Phillips®, Pozidriv® / Slotted, electrician, Phillips®, Pozidriv® screwdrivers	
17	60340, 60341, 60342, 60343, 60344, 60345, 60346, 60347, 60348, 60349, 60350, 60351, 60352, 60353, 60354, 60355, 60356		Llaves combinadas / Combination wrenches	
12	60300, 60301, 60302, 60303, 60304, 60306, 60309, 60310, 60311, 60312, 60313, 60314		Llaves fijas / Open-end wrenches	
25	60380, 60381, 60382, 60383, 60384, 60386, 60389, 60390, 60391, 60392, 60393, 60394		Llaves acodadas / Double offset ring wrenches	
5	61963		Juego / Set	
15	65113, 65114, 65115, 65116, 65117		Llaves de estrella carraca / Ratchet wrench	
7	65315, 65316, 65317, 65318, 65319, 65320, 65321, 65322, 65323, 65324, 65325, 65326, 65327, 65328, 65329		Llaves hexagonales / Hexagonal keys	
2	63401, 63402, 63403, 63404, 63405, 63406, 63407		Botadores / Punches	
10	63178, 63179		Cortafíos / Chisel	
2	62331, 62332, 62333, 62339, 62340, 62341, 62342, 62343, 62344, 62349		Alicates / Pliers	
1	62135, 62134		Tenazas de canal / Box joint pincers	
2	61112		Llave ajustable / Adjustable wrench	
29	62587, 62590		Extractores / Gear pullers	
1	63748		Arco de sierra / Hack Saw	
1	61961		Juego vasos / Socket set	
4	62963		Llave dinamométrica reversible / Reversible torque wrench	
33	69619, 69622, 69614, 69750		Martillos / Hammers	
1	66942		Juego puntas / Bits set	
3	61016		Llave HD / HD Pipe wrench	
6	62177, 62178, 62172		Tenazas Grip / Grip pincers	
1	63498, 63534, 63570, 63606, 63642, 63678		Limas / Files	
1	62233		Tijera de chapa / Tin snip	
2	69534		Tijera electricista / Electrician's scissors	
1	65485		Calibre / Caliper	
1	69571, 69574		Sargentos G / G Clamps	
11	65155		Nivel trapezoidal profesional / Professional bridge type spirit level	
1	66731		Destornillador portapuntas magnético / Screwdriver magnetic bitholder	
11	61267		Juego de vasos impacto / Impact socket sets	
1	62124		Tenaza rusa / Tower pincer	
4	69529		Set 4 pinzas / Set 4 tweezers	
1	62493		Alicata de terminales / Crimping pliers	
11	62666, 62667, 62668, 62669, 62670, 62671, 62672, 62673, 62674, 62675, 62676		Llave Mastergear / Mastergear Wrench	
6	66999		Juego destornilladores Microtronic / Microtronic screwdriver set	
1	65172		Flexómetro Rallye II / Rallye II Measuring tape	
6	63714, 63715, 63716, 63717, 63718, 63719		Limas de aguja / Needle files	
1	65595		Recogedor telescópico / Telescopic joing pick up	
1	65586		Espejo articulado / Joint telescopic mirror	
1	65773		Regla / Ruler	

■ 152 PCS.

■ MM





COD.	PCS.		Medidas en / Sizes in / Mesures en	
68970		-		35
68971	152	51025	mm	85
55770		50954		190

PCS.	Composición / Composition / Composition	Descripción / Description / Description	
16	62214, 62215, 62216, 62217, 62218, 62219, 62220, 62221, 62222, 62223, 62224, 62225, 62226, 62227, 62228, 62229	Alicates Circlips / Circlips pliers	-
18	66400, 66401, 66403, 66407, 66408, 76621, 76622, 76624, 76625, 76626, 66439, 66440, 66441, 76629, 76630, 66457, 66458, 66459	Destornilladores mecánicos, electricistas, Phillips®, Pozidriv® / Slotted, electrician, Phillips®, Pozidriv® screwdrivers	-
12	61725, 61726, 61727, 61728, 61729, 61730, 61731, 61732, 61733, 61734, 61735, 61736	Llaves combinadas / Combination wrenches	
8	61701, 61702, 61703, 61704, 61705, 61706, 61707, 61708	Llaves fijas / Open-end wrenches	mm
	61775, 61776, 61777, 61778, 61779, 61780, 61781, 61782	Llaves acodadas / Double offset ring wrenches	
25	61960	Juego / Set	1/2", mm, 25 pcs
10	61503, 61504, 61505, 61506, 61508, 61509, 61510, 65307, 65308, 65310	Llaves hexagonales / Hexagonal keys	mm
5	63402, 63403, 63404, 63405, 63406	Botadores / Punches	
2	63178, 63179	Cortafíos / Chisel	
6	62332, 62340, 62342, 62343, 62344, 62349	Alicates / Pliers	
1	62135	Tenazas de canal / Box joint pincers	-
	61112	Llave ajustable / Adjustable wrench	
2	62587, 62590	Extractores / Gear pullers	
1	63748	Arco de sierra / Hack Saw	
	62963	Llave dinamométrica reversible / Reversible torque wrench	1/2", 40-200 nm
4	69619, 69622, 69614, 69750	Martillos / Hammers	-
1	61016	Llave HD / HD Pipe wrench	12"
3	62177, 62178, 62172	Tenazas Grip / Grip pincers	
6	63498, 63534, 63570, 63606, 63642, 63678	Limas / Files	
	62233	Tijera de chapa / Tin snip	
1	69534	Tijera electricista / Electrician's scissors	-
	65479	Calibre Caliper / Vernier caliper	
2	69571, 69574	Sargentos G / G Clamps	
1	65155	Nivel trapezoidal profesional / Professional bridge type spirit level	400 mm
	62124	Tenaza rusa / Tower pincer	10"
4	69529	Set 4 pinzas / Set 4 tweezers	
	62493	Alicate de terminales / Crimping pliers	-
1	65172	Flexómetro Rallye II / Rallye II Measuring tape	3 m/16 mm
6	63714, 63715, 63716, 63717, 63718, 63719	Limas de aguja / Needle files	
	65595	Recogedor telescópico / Telescopic joining pick up	-
1	65586	Espejo articulado / Joint telescopic mirror	
	65774	Regla / Ruler	300 mm



## INCH





COD.	PCS.		Medidas en / Sizes in / Mesures en		
68972		-			33
68973	152	51025	inch	-	83
55771		50954		●	128

PCS.	Composición / Composition / Composition	Descripción / Description / Description	
16	62214, 62215, 62216, 62217, 62218, 62219, 62220, 62221, 62222, 62223, 62224, 62225, 62226, 62227, 62228, 62229	Alicates Circlips / Circlips pliers	
18	66400, 66401, 66403, 66407, 66408, 76621, 76622, 76624, 76625, 76626, 66439, 66440, 66441, 76629, 76630, 66457, 66458, 66459	Destornilladores mecánicos, electricistas, Phillips®, Pozidriv® / Slotted, electrician, Phillips®, Pozidriv® screwdrivers	
12	60341, 60342, 60343, 60344, 60345, 60347, 60348, 60349, 60351, 60352, 60353, 60354	Llaves combinadas / Combination wrenches	
8	60302, 60303, 60304, 60306, 60309, 60310, 60311, 60312	Llaves fijas / Open-end wrenches	inch
	60382, 60383, 60384, 60385, 60386, 60389, 60390, 60391	Llaves acodadas / Double offset ring wrenches	
25	61963	Juego / Set	1/2", inch, 25 pcs
10	65318, 65319, 65320, 65321, 65322, 65323, 65324, 65325, 65326, 65327	Llaves hexagonales / Hexagonal keys	inch
5	63402, 63403, 63404, 63405, 63406	Botadores / Punches	
2	63178, 63179	Cortafíos / Chisel	
6	62332, 62340, 62342, 62343, 62344, 62349	Alicates / Pliers	
1	62135	Tenazas de canal / Box joint pincers	-
	61112	Llave ajustable / Adjustable wrench	
2	62587, 62590	Extractores / Gear pullers	
1	63748	Arco de sierra / Hack Saw	
1	62963	Llave dinamométrica / Torque wrench	1/2", 40-200 nm
4	69619, 69622, 69614, 69750	Martillos / Hammers	-
1	61016	Llave HD / HD Pipe wrench	12"
3	62177, 62178, 62172	Tenazas Grip / Grip pincers	
6	63498, 63534, 63570, 63606, 63642, 63678	Limas / Files	
	62233	Tijera de chapa / Tin snip	
1	69534	Tijera electricista / Electrician's scissors	-
	65485	Calibre / Caliper	
2	69571, 69574	Sargentos G / G Clamps	
1	65155	Nivel trapezoidal profesional / Professional bridge type spirit level	400 mm
	62124	Tenaza rusa / Tower pincer	10"
4	69529	Set 4 pinzas / Set 4 tweezers	
1	62493	Alicate de terminales / Crimping pliers	-
1	65172	Flexómetro Rallye II / Rallye II Measuring tape	3 m/16 mm
6	63714, 63715, 63716, 63717, 63718, 63719	Limas de aguja / Needle files	
	65595	Recogedor telescópico / Telescopic joing pick up	-
1	65586	Espejo articulado / Joint telescopic mirror	
	65773	Regla / Ruler	300 mm



**JUEGO AERONÁUTICA / AVIATION SET / SET AÉRONAUTIQUE / WERKZEUG SET FÜR LUFTFAHRT / KIT PER AEREONAUTICA / JOGO AERONÁUTICA / АВИАЦИОННЫЙ НАБОР**
 158 PCS.

 INCH

COD.	PCS.		Medidas en / Sizes in / Mesures en	
68974				21
68975	158		inch	71
55772		51039		

PCS.	Composición / Composition / Composition	Descripción / Description / Description	
10	63380, 63381, 63382, 63401, 63402, 63403, 63404, 63405, 63406, 63407	Botadores / Punches	
6	63498, 63534, 63570, 63606, 63642, 63678	Limas / Files	
3	63178, 63179, 63180	Cortafíos / Chisel	
12	66874, 66875, 66877, 66880, 66883, 66885, 66897, 66898, 66899, 66938, 66901, 66902,	Destornilladores Rotork / Rotork Screwdrivers	
	65479	Calibre / Caliper	
1	61112	Llave ajustable / Adjustable wrench	
	62135	Tenazas de canal / Box joint pincers	
11	56223, 65369, 65370, 65371, 65373, 65375, 65377, 65378, 65380, 65381, 57598	Set dinamométrica / Reversible torque wrench set	
4	62333, 62343, 62337, 62339	Alicates / Pliers	
11	62695, 62696, 62697, 62698, 62699, 62700, 62701, 62702, 62703, 62704, 62705	Llaves de Mastergear Spline / Spline Mastergear wrenches	
15	60380, 60381, 60382, 60383, 60384, 60385, 60386, 60387, 60388, 60389, 60390, 60391, 60392, 60393, 60394	Llaves acodadas / Double offset ring wrenches	inch
14	60341, 60342, 60343, 60344, 60345, 60346, 60347, 60348, 60349, 60350, 60351, 60352, 60353, 60354	Llaves combinadas / Combination wrenches	
33	61963	Juego de vasos / Socket set	1/2"
1	63748	Arco de sierra / Hack Saw	
12	65315, 65316, 65317, 65318, 65319, 65320, 65321, 65322, 65323, 65324, 65325	Llaves hexagonales / Hexagonal keys	inch
1	69501	Cutter	
	65362	Flexómetros / Measuring tape	3 m/10'
2	69619, 55326	Martillos / Hammers	
1	65595	Recogedor telescópico / Telescopic joining pick up	
	65550	Galga de espesores / Feeler gauge	
6	63714, 63715, 63716, 63717, 63718, 63719	Limas de aguja / Needle files	
4	69529	Set 4 pinzas / Set 4 tweezers	
1	69534	Tijera electricista / Electrician's scissors	
3	62178, 62135, 62136	Tenazas Grip / Grip pincers	
	65586	Espejo articulado / Joint telescopic mirror	
1	62188	Tijera aviación articulada reforzada / Reinforced aviation tin snips	
	62136	Tenaza de sifón / Syphon plier	

■ 129 PCS.  
■ MM/INCH





COD.	PCS.			Medidas en / Sizes in / Mesures en		
<b>69004</b>	129	50995	50986	mm/inch	20	
PCS.	Composición / Composition / Composition		Descripción / Description / Description			
7	63401, 63402, 63403, 63404, 63405, 63406, 63407		Botador / Pin punch			
1	63437		Granete / Center punches			
28	58688, 58702		Juegos llaves de vaso / Socket wrench set			
23	60420, 60421, 60422, 60423, 60424, 60425, 60426, 60427, 60428, 60429, 60430, 60440, 60441, 60442, 60443, 60444, 60445, 60446, 60447, 60448, 60449, 60450, 60451		Llaves de vaso / Socket wrenches			1/4" & 3/8", inch
13	58537, 58538, 58539, 58540, 58541, 58542, 58543, 58544, 58545, 58546, 58547, 58548, 58549		Llaves fijas micromecánica / Micromech open end wrenches			inch
5	57288, 57289, 57290, 57291, 57292		Llaves de vaso articuladas / Universal socket			1/4", inch
4	60340, 60341, 67878, 67954		Llaves combinadas / Combination wrenches			inch
1	62129		Tenaza de canal / Box joint pincer			-
	62090		Alicate tipo Ford / Slip joint plier			-
6	62247, 62332, 62339, 62340, 62343, 62540		Alicates / Pliers			-
1	62624		Alicate trenzador de alambre / Wire twist plier			-
6	61442, 61443, 61444, 61447, 61450, 61459		Alargaderas / Extensions			1/4" & 3/8", inch
2	55327, 69704		Martillos / Hammers			-
3	62169, 62170, 62171		Tijeras / Snips			-
2	61435, 61436		Articulaciones universales / Universal joints			1/4" & 3/8", inch
	62603, 62604		Llaves de carraca reversibles / Reversible ratchet handles			1/4" & 3/8"
10	61516		Juego llaves allen / Set of hexagonal key wrenches			inch
2	63536, 63572		Limas / Files			-
	65570		Galgas de espesores / Feeler gauge			-
	65586		Espejo telescópico / Telescopic joint mirror			-
	65588		Recogedor telescópico / Telescopic joint pick up			-
	65603		Aguja de trazar / Scriber			-
	65836		Regla métrica INOX / Stainless steel ruler			600 mm
1	58241		Punta Phillips® / Phillips® bit			-
	66937		Destornillador carrocerero Rotork® / Rotork stubby screwdriver			-
	63742		Arco de sierra / Hack Saw			-
	79598		Linterna MasterEx / MasterEx flashlight			-
	61577		Cepillo INOX / Stainless steel universal brush			-

### JUEGOS AUTOMOCIÓN / SETS FOR AUTOMOTIVE / SETS AUTOMOBILE / SETS FÜR AUTOMOTIVE / SET RIPARAZIONE / JOGOS PARA SETOR AUTOMÓVEL / НАБОР ДЛЯ АВТОМОБИЛЕЙ

364 PCS.

MM



COD.	PCS.		Medidas en / Sizes in / Mesures en	
51668		-		46
51669	364	50954	mm	158
51670				160

PCS.	Composición / Composition / Composition	Descripción / Description / Description	
54	53000, 53001, 53002, 53003, 53004, 53005, 53006, 53007, 53008, 53009, 53010, 53011, 53013, 53015, 53016, 53017, 53019, 53021, 53023, 53024, 53025, 53034, 53035, 53036, 53037, 53038, 53039, 53041, 53042, 53043, 53044, 53045, 53046, 55697, 55698, 55699, 55700, 58900, 66733, 66734, 66735, 66736, 66737, 66738, 66739, 66740, 66741, 66742, 66743, 66744, 66745, 66746, 66747, 67164		1/4"
73	53105, 53107, 53108, 53109, 53110, 53120, 53121, 53122, 53123, 53124, 53125, 53127, 53128, 53129, 53131, 53132, 53133, 53134, 53136, 53137, 53138, 53139, 53149, 53150, 53151, 53152, 53153, 53154, 53155, 53156, 53157, 53158, 53159, 55705, 55706, 55707, 55708, 56896, 65985, 65986, 65987, 65988, 65989, 65990, 65991, 65992, 65993, 66802, 66803, 66804, 66805, 66806, 66812, 66813, 66814, 66816, 66817, 66818, 66819, 66820, 66821, 66822, 66823, 66824, 66825, 66826, 66828, 66829, 66830, 66842, 67213, 67214, 66827	Puntas atornilladoras con vaso / Socket bits	1/2"
26	56015, 56017, 56018, 56020, 57165, 57166, 57167, 57168, 57169, 57170, 61311, 61312, 61313, 61314, 61315, 61322, 63974, 63975, 67640, 67641, 67642, 67643, 67644, 67645, 67647		1/4"
56	55795, 55796, 55797, 55798, 55801, 57180, 57181, 57182, 57183, 57184, 57185, 57186, 57187, 61381, 61382, 61383, 61384, 61385, 61386, 61387, 61388, 61389, 61390, 61391, 61392, 61393, 61394, 61395, 61396, 61397, 61398, 61399, 61400, 61401, 61402, 61403, 67780, 67781, 67782, 67783, 67784, 67785, 67786, 67787, 67788, 67789, 67791, 67792, 67793, 67794, 67795, 67796, 67797, 67798, 67799, 67800	Llaves de vaso / Socket wrenches	1/2"
2	61462, 61463	Llaves de vaso para bujías / Spark plug sockets	
5	57410, 57411, 57413, 62603, 62606	Llaves de carraca reversibles / Reversible ratchet handles	
25	61530, 61531, 61532, 61533, 61534, 61535, 61536, 61537, 61538, 61539, 61540, 61541, 62710, 62711, 62712, 62713, 62714, 62715, 62716, 62717, 62718, 62719, 62720, 62721	Llaves combinadas de carraca / Combination ratchet wrenches	
9	61701, 61702, 61703, 61704, 61705, 61706, 61707, 61708, 61709	Llaves fijas / Open-end wrenches	-
	61775, 61776, 61777, 61778, 61779, 61780, 61781, 61782, 61783	Llaves acodadas / Double offset ring wrenches	
	60785, 60786, 60788, 60789, 60790	Llaves para racores / Flare nut wrenches	
5	62734, 62735, 62736, 62737, 62738	Llaves E-Torx / E-Torx wrenches	
	61442, 61443, 61444, 61445, 62731		1/4"
	61453, 61455, 61458, 61464, 62119	Alargaderas / Extensions	1/2"
4	62180, 62181, 62182, 62183	Alicates Circlips / Circlips pliers	
1	51215	Alicate para cables de bujía / Spark plug lead plier	
3	51219, 51220, 51221	Alicates para manguitos / Hose clamps	
	62591	Alicate para terminales aislados / Plier for insulated terminals	
1	62594	Alicate para unión de cables aislados y no aislados / Plier for cable links insulated and no insulated	
7	62332, 62337, 62340, 62342, 62343, 62344, 63955	Alicates / Pliers	
1	61580	Cepillo soldadura / Soldering brush	
2	62169, 62171	Tijeras articuladas / Aviation tin snips	-
3	62172, 62178, 62485	Tenazas Grip / Grip pincers	
2	62706, 62707	Tenazas de canal / Box joint pincers	
1	56184	Tenazas axiales / Axial grip pliers	
5	63533, 63569, 63605, 63606, 63677	Limas / Files	
	67195	Rasqueta para juntas / Gasket scraper	
	51227	Palanca para desmontar neumáticos / Tyre-removers	
	51230	Herramienta para extracción de clips / Fastener removal tool	
	61408		1/4"
	61434	Berbiqui / Speeder handle	1/2"
	63299	Arco de sierra / Hack saws	
1	63874	Cutter	
	63862	Pelacables / Cable stripper	
	65165	Flexómetro Robust Bimat / Robust Bimat Measuring tape	-
	65480	Calibre pie de rey / Vernier Caliper	
	65491	Calibre de profundidad / Depth gauge	
	65568	Galgas de espesores / Feeler gauge	
	65774	Regla / Ruler	300 mm
	65820	Goniómetro / Protractor	
24	66487, 66488, 66489, 66490, 66491, 66492, 66493, 66494, 66495, 66496, 66497, 66731, 66732, 66874, 66875, 66877, 66878, 66881, 66882, 66887, 66897, 66898, 66899, 66900	Destornilladores mecánico, portavasos, portapuntas, electricista, Phillips®, Torx® / Slotted, socket holder, bitholder, electrician, Phillips®, Torx® screwdrivers	-
3	58239, 58244, 58265	Puntas de destornillador Masterbit / Masterbit bits	
4	55265, 65846, 65884		1/4"
2	65880, 65885	Adaptadores / Adapters	3/8"
	65881	Adaptador / Adapter	1/2"
	61435	Articulación universal / Universal joint	
	61438	Mango corredizo / Sliding-T-handle	1/4"
1	65874	Mango articulado / Swivel handle	
	61484	Mango articulado telescópico / Telescopic swivel handle	1/2"
	63468	Granete con mago / Center punch with handle	-
	65589	Recogedor telescópico articulado / Telescopic joint pick up	



■ 158 PCS.

■ MM



COD.	PCS.	Medidas en / Sizes in / Mesures en	Kg
51665	-	-	17
51666	158	mm	90
51667	-	-	-



PCS.	Composición / Composition / Composition	Descripción / Description / Description	
1	55327	Martillo nylon mango Hickory / Nylon hammer Hickory handle	-
6	53013, 66743, 66744, 66745, 66746, 66747	Puntas atornilladoras con vaso hexagonales / Hexagonal socket bits	1/4"
23	58155, 58156, 58157, 58160, 58163, 58164, 58165, 58188, 58253, 58254, 58255, 58257, 58258, 58272, 58284, 58286, 58287, 58290, 58292, 58293, 58295, 58296, 58297	Puntas de destornillador Masterbit / Masterbit bits	-
14	60423, 61311, 61312, 61313, 61314, 61315, 61316, 61317, 61318, 61319, 61320, 61321, 63974, 63975	Llaves de vaso / Socket wrenches	1/4"
19	61802, 61803, 61804, 61805, 61806, 61807, 61808, 61809, 61810, 61811, 61812, 61813, 61814, 61815, 61816, 61818, 61819, 61822, 61823	Llaves combinadas / Combination wrenches	1/2"
22	60952, 61725, 61726, 61727, 61728, 61729, 61730, 61731, 61732, 61733, 61734, 61735, 61736, 61737, 61738, 61739, 61740, 61741, 61743, 61746, 61749, 61750	Llaves combinadas / Combination wrenches	-
7	61775, 61776, 61777, 61778, 61779, 61780, 61781	Llaves acodadas / Double offset ring wrenches	-
4	62180, 62181, 62182, 62183	Alicates Circlips / Circlips pliers	-
3	62332, 62339, 62343	Alicates / Pliers	-
	69621	Martillo alemán / German type machinist's hammer	-
	69502	Cutter	-
	64005	Cuchilla / Blade	-
	65172	Flexómetro / Measuring tape	-
1	61580	Cepillo soldadura / Soldering brush	-
	61435	Articulación universal / Universal joint	1/4"
	61437	Articulación universal / Universal joint	1/2"
	61438	Mango corredizo en T / Sliding T handle	1/4"
	61440	Mango corredizo en T / Sliding T handle	1/2"
2	61442, 61444	Alargaderas / Extensions	1/4"
	61455, 61458	Alargaderas / Extensions	1/2"
	62128	Tenaza de canal / Box joint pincer	-
1	62172	Tenaza Grip / Grip pincer	-
	62603	Llave de carraca reversible / Reversible ratchet handle	1/4"
	62606	Llave de carraca reversible / Reversible ratchet handle	1/2"
9	63394, 63395, 63396, 63397, 63398, 63399, 63408, 63409, 63410	Botadores / Punches	-
3	62849, 63309, 63311	Cinceles / Chisels	-
1	62871	Buril plano / Crosscut chisel	-
	63437	Granete / Center punch	-
5	63498, 63570, 63606, 63642, 63678	Limas / Files	-
1	65591	Recogedor telescópico / Telescopic joint pick up	-
22	66571, 66572, 66573, 66574, 66575, 66732, 66886, 66887, 66888, 66890, 66892, 66897, 66898, 66899, 66919, 66921, 66922, 66923, 66924, 66926, 66937, 67190	Destornilladores T-Mastertork, portavasos, electricistas, Phillips®, Torx®, carroceros / T-Mastertork, socket holder, electrician, Phillips®, Torx®, Stubby screwdrivers	-

### JUEGOS MECÁNICA / SETS FOR MECHANICS / SETS DE MÉCANICIENS / WERKZEUG SETS FÜR MECHANIKER / KIT MECCANICA / JOGO DE MECÂNICA / МЕХАНИЧЕСКИЕ НАБОРЫ

419 PCS.

MM



COD.	PCS.		Medidas en / Sizes in / Mesures en	
68976	-	-	-	127
68977	419	50950	mm	222
55773	-	51074	●	538



PCS.	Composición / Composition / Composition	Descripción / Description / Description	
20	62214, 62215, 62216, 62217, 62218, 62219, 62220, 62221, 62222, 62223, 62224, 62225, 62226, 62227, 62228, 62229, 62180, 62181, 62182, 62183	Alicates Circlips / Circlips pliers	
9	66400, 66401, 66403, 66405, 66407, 66408, 66409, 66410, 66525	Destornilladores mecánicos / Slotted screwdrivers	
7	76620, 76621, 76622, 76624, 76625, 76626, 76627	Destornilladores electricistas / Electrician screwdrivers	
6	66438, 66439, 66440, 66441, 66442, 66526	Destornilladores Phillips® / Phillips® screwdriver	
	66456, 66457, 66458, 66459, 66460, 66527	Destornilladores Pozidriv® / Pozidriv® screwdrivers	
13	66474, 66475, 66476, 66477, 66478, 66479, 66480, 66481, 66482, 66483, 66484, 66485, 66486	Destornilladores Torx® / Torx® screwdrivers	
7	66571, 66572, 66573, 66574, 66575, 66576, 66577	Destornilladores T-Mastertork / T-Mastertork screwdrivers	-
16	69870	Set reversible Mastergear / Set rev. Mastergear	
13	61824, 61825, 61826, 61827, 61828, 61829, 61830, 61831, 61832, 61833, 61834, 61835, 61836	Llaves de tubo doble boca / Socket double ended wrench	
18	61840, 61841, 61842, 61843, 61844, 61845, 61846, 61847, 61848, 61849, 61850, 61851, 61852, 61853, 61854, 61855, 61856, 61858	Llaves articuladas en T / T-handle wrenches with universal joint	
32	61725, 61726, 61727, 61728, 61729, 61730, 61731, 61732, 61733, 61734, 61735, 61736, 61737, 61738, 61739, 61740, 61741, 61742, 61743, 61744, 61745, 61746, 61747, 61748, 61749, 61750, 60951, 60952, 60953, 60954, 60955, 60956	Llaves combinadas / Combination wrenches	
14	61701, 61702, 61703, 61704, 61705, 61706, 61707, 61708, 61709, 61710, 61711, 61712, 61713	Llaves fijas / Open-end wrenches	mm
16	61775, 61776, 61777, 61778, 61779, 61780, 61781, 61782, 61783, 61784, 61785, 61786, 61787, 61788, 61789, 61790	Llaves acodadas / Double offset ring wrenches	
25	61960	Juego / Set	
26	61870, 61871, 61872, 61873, 61874, 61875, 61876, 61877, 61878, 61879, 61880, 61881, 61882, 61883, 61884, 61885, 61886, 61887, 61888, 61889, 61890, 61891, 61892, 61893, 61894, 61895	Llaves de pipa / Angled sockets	1/2", mm, 26 pcs
23	65302, 65303, 65304, 65305, 65306, 65307, 65308, 65309, 65310, 65311, 65312, 65313, 65314, 61501, 61502, 61503, 61504, 61505, 61506, 61507, 61508, 61509, 61510	Llaves hexagonales / Hexagonal keys	mm
7	63401, 63402, 63403, 63404, 63405, 63406, 63407	Botadores octogonales / Octagonal punches	
6	63435, 63436, 63437, 63438, 63439, 63440	Granetes hexagonales / Hexagonal center punches	
3	63178, 63179, 63180	Cortafíos / Chisel	
13	62331, 62332, 62333, 62337, 62338, 62339, 62340, 62341, 62342, 62343, 62344, 62345, 62349	Alicates / Pliers	-
3	62133, 62135, 62134	Tenazas de canal / Box joint pincers	
2	61112, 61114	Llave ajustable / Adjustable wrench	
5	62586, 62587, 62588, 62589, 62590	Extractores / Gear pullers	
1	63748	Arco de sierra / Hack Saw	
29	61958	Juego vasos / Socket set	1/4", mm
1	62963	Llave dinamométrica / Torque wrench	1/2" 40-200 nm
7	69619, 69622, 69614, 69750, 69742, 69729, 69521	Martillos / Hammers	
33	66942	Juego puntas / Bits set	-
1	61016	Llave HD / HD Pipe wrench	12"
3	62177, 62178, 62172	Tenazas Grip / Grip pincers	
6	63498, 63534, 63570, 63606, 63642, 63678	Limas / Files	
	62233	Tijera de chapa / Tin snip	-
	69534	Tijera electricista / Electrician's scissors	
1	65479	Calibre / Caliper	
	65155	Nivel trapezoidal profesional / Professional bridge type spirit level	400 mm
	66731	Destornillador portapuntas magnético / Screwdriver magnetic bitholder	-
10	60693	Juego de vasos impacto / Impact socket sets	mm
4	69529	Set 4 pinzas / Set 4 tweezers	
1	62493	Alicata de terminales / Crimping pliers	
11	65089, 65090, 65091, 65092, 65093, 65095, 65096, 65098, 65099, 65100, 65102	Llaves de carraca para racores / Ratcheting ring wrench	
1	69504	Magnetizador-desmagnetizador / Magnetizer-demagnetizer	
	65362	Flexómetro / Measuring tape	3 m, mm/inch
6	63714, 63715, 63716, 63717, 63718, 63719	Limas de aguja / Needle files	
	65595	Recogedor telescópico / Telescopic joing pick up	-
	65586	Espejo articulado / Joint telescopic mirror	
	65774	Regla / Ruler	300 mm
	63119	Cortatubos cobre / Cooper tube cutter	42 mm
1	63172	Cortatubos acero / Steel tube cutter	2"
	63205	Cortatubos plástico Piraina / Piraina plastic pipe cutter	
	69501	Cutter	
	51259	Multímetro digital para automóviles / Automotive digital multimeter	-
	65388	Navaja / Penknife	

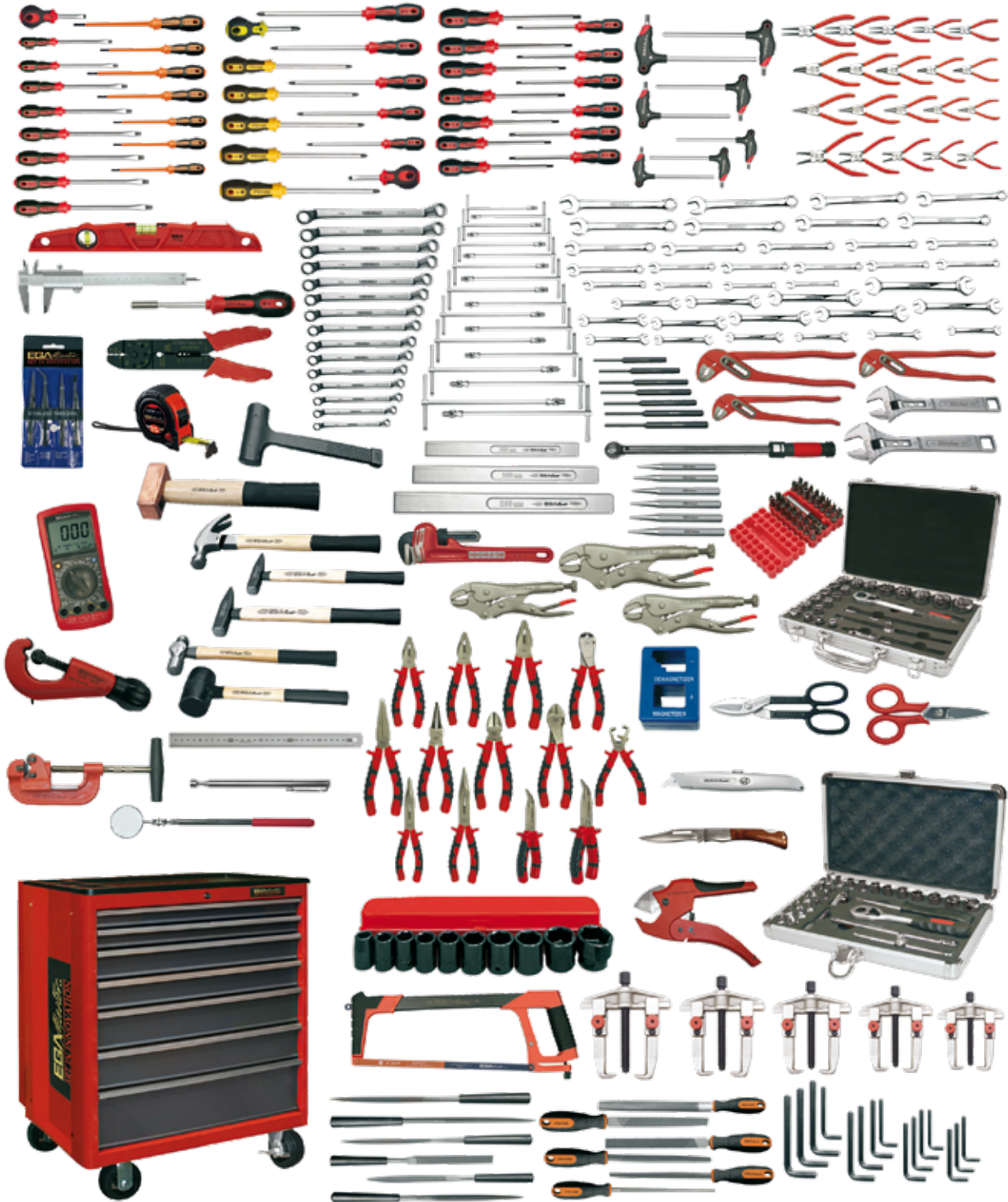

■ 337 PCS.

■ INCH



COD.	PCS.		Medidas en / Sizes in / Mesures en		
68978					87
68979	337		50950	inch	182
55774			51117, 51039	●	343





PCS.	Composición / Composition / Composition	Descripción / Description / Description	
20	62214, 62215, 62216, 62217, 62218, 62219, 62220, 62221, 62222, 62223, 62224, 62225, 62226, 62227, 62228, 62229, 62180, 62181, 62182, 62183	Alicates Circlips / Circlips pliers	
9	66400, 66401, 66403, 66405, 66407, 66408, 66409, 66410, 66525	Destornilladores mecánicos / Slotted screwdrivers	
7	76620, 76621, 76622, 76624, 76625, 76626, 76627	Destornilladores electricistas / Electrician screwdrivers	
5	66438, 66439, 66440, 66441, 66442, 66526	Destornilladores Phillips® / Phillips® screwdriver	
	66456, 66457, 66458, 66459, 66460, 66527	Destornilladores Pozidriv® / Pozidriv® screwdrivers	
13	66474, 66475, 66476, 66477, 66478, 66479, 66480, 66481, 66482, 66483, 66484, 66485, 66486	Destornilladores Torx® / Torx® screwdrivers	
7	66571, 66572, 66573, 66574, 66575, 66576, 66577	Destornilladores T-Mastertork / T-Mastertork screwdrivers	
18	61840, 61841, 61842, 61843, 61844, 61845, 61846, 61847, 61848, 61849, 61850, 61851, 61852, 61853, 61854, 61855, 61856, 61858	Llaves articuladas en T / T-handle wrenches with universal joint	
23	60340, 60341, 60342, 60343, 60344, 60345, 60346, 60347, 60348, 60349, 60350, 60351, 60352, 60353, 60354, 60355, 60356, 60357, 60358, 60957, 60958, 60959, 60960	Llaves combinadas / Combination wrenches	
15	60300, 60301, 60302, 60303, 60304, 60305, 60306, 60307, 60308, 60309, 60310, 60311, 60312, 60313, 60314	Llaves fijas / Open-end wrenches	inch
	60380, 60381, 60382, 60383, 60384, 60385, 60386, 60387, 60388, 60389, 60390, 60391, 60392, 60393, 60394	Llaves acodadas / Double offset ring wrenches	
25	61963	Llaves de vaso, extensiones, carraca, mango corredizo en T, articulación universal	1/2", exten. 5" - 10"
15	65315, 65316, 65317, 65318, 65319, 65320, 65321, 65322, 65323, 65324, 65325, 65326, 65327, 65328, 65329	Llaves hexagonales / Hexagonal keys	inch
7	63401, 63402, 63403, 63404, 63405, 63406, 63407	Botadores octogonales / Octagonal punches	
6	63435, 63436, 63437, 63438, 63439, 63440	Granetes hexagonales / Hexagonal center punches	
3	63178, 63179, 63180	Cortafrios / Chisel	
13	62331, 62332, 62333, 62337, 62338, 62339, 62340, 62341, 62342, 62343, 62344, 62345, 62349	Alicates / Pliers	
3	62133, 62135, 62134	Tenazas de canal / Box joint pincers	
2	61112, 61114	Llave ajustable / Adjustable wrench	
5	62586, 62587, 62588, 62589, 62590	Extractores / Gear pullers	
1	63748	Arco de sierra / Hack Saw	
29	61961	Juego vasos / Socket set	1/4", inch
1	62963	Llave dinamométrica reversible / Reversible torque wrench	1/2", 40-200 nm
7	69619, 69622, 69614, 69750, 69742, 69729, 69521	Martillos / Hammers	
33	66942	Juego puntas / Bits set	
1	61016	Llave HD / HD Pipe wrench	12"
3	62177, 62178, 62172	Tenazas Grip / Grip pincers	
6	63498, 63534, 63570, 63606, 63642, 63678	Limas / Files	
	62233	Tijera de chapa / Tin snip	
	69534	Tijera electricista / Electrician's scissors	
1	65479	Calibre / Caliper	
	65155	Nivel trapezoidal profesional / Professional bridge type spirit level	400 mm
	66731	Destornillador portapuntas magnético / Screwdriver magnetic bitholder	
11	61267	Juego de vasos impacto / Impact socket sets	inch
4	69529	Set 4 pinzas / Set 4 tweezers	
	62493	Alicate de terminales / Crimping pliers	
1	69504	Magnetizador-desmagnetizador / Magnetizer-demagnetizer	
	65362	Flexómetros / Measuring tape	3m/10'
6	63714, 63715, 63716, 63717, 63718, 63719	Limas de aguja / Needle files	
	65595	Recogedor telescópico / Telescopic joing pick up	
	65586	Espejo articulado / Joint telescopic mirror	
	65774	Regla / Ruler	300 mm
	63119	Cortatubos cobre / Cooper tube cutter	42 mm
1	63172	Cortatubos acero / Steel tube cutter	2"
	63205	Cortatubos plástico Piraina / Piraina plastic pipe cutter	
	69501	Cutter	
	51259	Multímetro digital para automóviles / Automotive digital multimeter	
	65388	Navaja / Penknife	

■ 228 PCS.

■ MM





COD.	PCS.		Medidas en / Sizes in / Mesures en		
68980		-			49
68981	228	51025	mm	-	99
55775		57060		●	305
PCS.	Composición / Composition / Composition			Descripción / Description / Description	
16	62214, 62215, 62216, 62217, 62218, 62219, 62220, 62221, 62222, 62223, 62224, 62225, 62226, 62227, 62228, 62229			Alicates Circlips / Circlips pliers	
18	66400, 66401, 66403, 66407, 66408, 76621, 76622, 76624, 76625, 76626, 66439, 66440, 66441, 76629, 76630, 66457, 66458, 66459			Destornilladores mecánicos, electricistas, Phillips®, Pozidriv® / Slotted, electrician, Phillips®, Pozidriv® screwdrivers	
13	66474, 66475, 66476, 66477, 66478, 66479, 66480, 66481, 66482, 66483, 66484, 66485, 66486			Destornilladores Torx® / Torx® screwdrivers	
7	66571, 66572, 66573, 66574, 66575, 66576, 66577			Destornilladores T-Mastertork / T-Mastertork screwdrivers	
13	61824, 61825, 61826, 61827, 61828, 61829, 61830, 61831, 61832, 61833, 61834, 61835, 61836			Llaves de tubo doble boca / Socket double ended wrench	
12	61725, 61726, 61727, 61728, 61729, 61730, 61731, 61732, 61733, 61734, 61735, 61736			Llaves combinadas / Combination wrenches	
8	61701, 61702, 61703, 61704, 61705, 61706, 61707, 61708			Llaves fijas / Open-end wrenches	
	61775, 61776, 61777, 61778, 61779, 61780, 61781, 61782			Llaves acodadas / Double offset ring wrenches	
17	61796			Juego llaves vaso / Socket wrench set	
10	61503, 61504, 61505, 61506, 61508, 61509, 61510, 65307, 65308, 65310			Llaves hexagonales / Hexagonal keys	
7	63401, 63402, 63403, 63404, 63405, 63406, 63407			Botadores octogonales / Octagonal punches	
6	63435, 63436, 63437, 63438, 63439, 63440			Granetes hexagonales / Hexagonal center punches	
3	63178, 63179, 63180			Cortafíos / Chisel	
6	62332, 62340, 62342, 62343, 62344, 62349			Alicates / Pliers	
1	62135			Tenazas de canal / Box joint pincers	
	61112			Llave ajustable / Adjustable wrench	
2	62587, 62590			Extractores / Gear pullers	
1	63748			Arco de sierra / Hack Saw	
	62963			Llave dinamométrica reversible / Reversible torque wrench	
7	69619, 69622, 69614, 69750, 69742, 69729, 69521			Martillos / Hammers	
33	66942			Juego puntas / Bits set	
1	61016			Llave HD / HD Pipe wrench	
3	62177, 62178, 62172			Tenazas Grip / Grip pincers	
6	63498, 63534, 63570, 63606, 63642, 63678			Limas / Files	
	62233			Tijera de chapa / Tin snip	
	69534			Tijera electricista / Electrician's scissors	
1	65479			Calibre / Caliper	
	65155			Nivel trapezoidal profesional / Professional bridge type spirit level	
	66731			Destornillador portapuntas magnético / Screwdriver magnetic bitholder	
10	60693			Juego de vasos impacto / Impact socket sets	
4	69529			Set 4 pinzas / Set 4 tweezers	
	62493			Alicata de terminales / Crimping pliers	
	69504			Magnetizador-desmagnetizador / Magnetizer-demagnetizer	
	65362			Flexómetros / Measuring tape	
	65595			Recogedor telescópico / Telescopic joing pick up	
1	65586			Espejo articulado / Joint telescopic mirror	
	65774			Regla / Ruler	
	63205			Cortatubos plástico Piraina / Piraina plastic pipe cutter	
	69501			Cutter	
	65388			Navaja / Penknife	

■ 216 PCS.

■ INCH





COD.	PCS.		Medidas en / Sizes in / Mesures en	
68982		-		47
68983	216	51025	inch	97
55776		50977	●	303

PCS.	Composición / Composition / Composition	Descripción / Description / Description	
16	62214, 62215, 62216, 62217, 62218, 62219, 62220, 62221, 62222, 62223, 62224, 62225, 62226, 62227, 62228, 62229	Alicates Circlips / Circlips pliers	
18	66400, 66401, 66403, 66407, 66408, 76621, 76622, 76624, 76625, 76626, 66439, 66440, 66441, 76629, 76630, 66457, 66458, 66459	Destornilladores mecánicos, electricistas, Phillips®, Pozidriv® / Slotted, electrician, Phillips®, Pozidriv® screwdrivers	
13	66474, 66475, 66476, 66477, 66478, 66479, 66480, 66481, 66482, 66483, 66484, 66485, 66486	Destornilladores Torx® / Torx® screwdrivers	-
7	66571, 66572, 66573, 66574, 66575, 66576, 66577	Destornilladores T-Mastertork / T-Mastertork screwdrivers	
12	60341, 60342, 60343, 60344, 60345, 60347, 60348, 60349, 60351, 60352, 60353, 60354	Llaves combinadas / Combination wrenches	
8	60302, 60303, 60304, 60306, 60309, 60310, 60311, 60312	Llaves fijas / Open-end wrenches	
	60382, 60383, 60384, 60385, 60386, 60389, 60390, 60391	Llaves acodadas / Double offset ring wrenches	
17	61798	Juego llaves vaso / Socket wrench set	1/2", inch
10	65318, 65319, 65320, 65321, 65322, 65323, 65324, 65325, 65326, 65327	Llaves hexagonales / Hexagonal keys	inch
7	63401, 63402, 63403, 63404, 63405, 63406, 63407	Botadores octogonales / Octagonal punches	
6	63435, 63436, 63437, 63438, 63439, 63440	Granetes hexagonales / Hexagonal center punches	
3	63178, 63179, 63180	Cortafíos / Chisel	
6	62332, 62340, 62342, 62343, 62344, 62349	Alicates / Pliers	
1	62135	Tenazas de canal / Box joint pincers	
	61112	Llave ajustable / Adjustable wrench	
2	62587, 62590	Extractores / Gear pullers	
1	63748	Arco de sierra / Hack Saw	
	62963	Llave dinamométrica / Torque wrench	1/2", 40-200 nm
7	69619, 69622, 69614, 69750, 69742, 69729, 69521	Martillos / Hammers	
33	66942	Juego puntas / Bits set	
1	61016	Llave HD / HD Pipe wrench	12"
3	62177, 62178, 62172	Tenazas Grip / Grip pincers	
6	63498, 63534, 63570, 63606, 63642, 63678	Limas / Files	
	62233	Tijera de chapa / Tin snip	
	69534	Tijera electricista / Electrician's scissors	
1	65479	Calibre / Caliper	
	65155	Nivel trapezoidal profesional / Professional bridge type spirit level	400 mm
	66731	Destornillador portapuntas magnético / Screwdriver magnetic bitholder	
11	61267	Juego de vasos impacto / Impact socket sets	
4	69529	Set 4 pinzas / Set 4 tweezers	
	62493	Alicate de terminales / Crimping pliers	
	69504	Magnetizador-desmagnetizador / Magnetizer-demagnetizer	
	65362	Flexómetros / Measuring tape	3m/10'
	65595	Recogedor telescópico / Telescopic joing pick up	
1	65586	Espejo articulado / Joint telescopic mirror	
	65774	Regla / Ruler	300 mm
	63205	Cortatubos plástico Piraina / Piraina plastic pipe cutter	
	69501	Cutter	
	65388	Navaja / Penknife	

■ 135 PCS.

■ MM



COD.	PCS.		Medidas en / Sizes in / Mesures en	
69396	135	51011	mm	60



PCS.	Composición / Composition / Composition	Descripción / Description / Description	
25	61960	Juego / Set	1/2", 25 pcs
	69280	Juego llaves combinadas / Combination wrenches set	26 pcs
26	61870, 61871, 61872, 61873, 61874, 61875, 61876, 61877, 61878, 61879, 61880, 61881, 61882, 61883, 61884, 61885, 61886, 61887, 61888, 61889, 61890, 61891, 61892, 61893, 61894, 61895	Llaves de pipa / Angled sockets	6-32
10	61500	Juego llaves Allen / Allen keys wrenches Set	1,5/2/2,5/3/4/5/5,5/6/8/10, hex.
	61110	Llave ajustable Unique Plus / Unique Plus adjustable wrench	6"
1	61935	Llave ajustable Alavesa Combi Unique Plus / Basque Combi Unique Plus adjustable wrench	12"
5	66877, 66878, 66879, 66881, 66882	Destornilladores mecánico / Slotted screwdriver	
	66898, 66899, 66900	Destornilladores Phillips® Rotork / Phillips® Rotork screwdrivers	
3	66908, 66909, 66910	Destornilladores Pozidriv® / Pozidriv® screwdrivers	
	66921, 66923, 66926	Destornilladores Torx® Rotork / Rotork Torx® screwdrivers	
	62332	Alicate universal Titacrom® / Titacrom® Combination pliers	
	62340	Alicate telefonista Titacrom® / Titacrom® Long nose pliers pliers	
	62342	Alicate telefonista b/curva / Titacrom® bent nose pliers	
	62344	Cortaalambres reforzado / Heavy Duty cutting nippers	
	62129	Tenaza canal / Box joint plier	
1	62172	Tenaza Grip curva / Curved Grip pliers	
	62349	Alicate pelacables / Wirestripper	
	62216	Alicate Circlips exterior recto / External straight Circlips pliers	
	62220	Alicate Circlips exterior curvo / External bent Circlips pliers	
	62224	Alicate Circlips interior recto / Internal straight Circlips pliers	
	62228	Alicate Circlips interior curvo / Internal bent Circlips pliers	
	63748	Arco de sierra / Hack Saw	
10	64435	Hojas de sierra acero al carbono / Carbon steel hacksaw blade	24 dientes / 24 teeth
	69621	Martillo alemán / German type machinist's hammer	
	69616	Martillo de bola / Ball pein hammer	-
	55326	Martillo de nylon / Nylon hammer	
	61017	Llave Heavy Duty / Heavy Duty pipe wrench	14"
1	61035	Llave de cadena reversible / Reversible chain pipe wrench	-
	61480	Llave de correa / Strap wrench	
	63119	Cortatubos Unique / Unique tube cutter	42 mm
	68003	Abocinador / Pulg flaring tool	
	62151	Tenaza cortacables / Cable cutters	-
	69501	Cutter	



■ 109 PCS.

■ MM



COD.	PCS.		Medidas en / Sizes in / Mesures en		
68984		-			27
68985	109	51674	mm	-	67
55777		51025		●	122

PCS.	Composición / Composition / Composition	Descripción / Description / Description	
8	62214, 62215, 62216, 62217, 62222, 62223, 62224, 62225	Alicates Circlips / Circlips pliers	
11	66400, 66401, 66403, 66407, 66408, 66439, 66440, 66441, 66457, 66458, 66459	Destornilladores mecánicos, Phillips®, Pozidriv® / Slotted, Phillips®, Pozidriv® screwdrivers	-
10	66475, 66476, 66477, 66478, 66479, 66480, 66481, 66482, 66483, 66484	Destornilladores Torx® / Torx® screwdrivers	
12	61725, 61726, 61727, 61728, 61729, 61730, 61731, 61732, 61733, 61734, 61735, 61736	Llaves combinadas / Combination wrenches	mm
8	61701, 61702, 61703, 61704, 61705, 61706, 61707, 61708	Llaves fijas / Open-end wrenches	
	61775, 61776, 61777, 61778, 61779, 61780, 61781, 61782	Llaves acodadas / Double offset ring wrenches	-
17	61796	Juego llaves vaso / Socket wrench set	1/2", mm
10	61503, 61504, 61505, 61506, 61508, 61509, 61510, 65307, 65308, 65310	Llaves hexagonales / Hexagonal keys	mm
3	63402, 63404, 63406	Botadores / Punches	
1	63179	Cortafíos / Chisel	
4	62332, 62343, 62344, 62349	Alicates / Pliers	
1	62135	Tenazas de canal / Box joint pincers	
	61112	Llave ajustable / Adjustable wrench	
2	62587, 62590	Extractores / Gear pullers	
1	62963	Llave dinamoétrica reversible / Reversible torque wrench	1/2", 40-200 nm
4	69619, 69622, 69614, 69750	Martillos / Hammers	
1	62178	Tenazas Grip / Grip pincers	
3	63498, 63570, 63678	Limas / Files	
	62233	Tijera de chapa / Tin snip	
1	65362	Flexómetros / Measuring tape	3 m/10'
	65595	Recogedor telescópico / Telescopic joing pick up	
	69501	Cutter	

### INCH





COD.	PCS.		Medidas en / Sizes in / Mesures en	
68986		-		27
68987	109	51674	inch	67
55778		51025	●	122

PCS.	Composición / Composition / Composition	Descripción / Description / Description	
8	62214, 62215, 62216, 62217, 62222, 62223, 62224, 62225	Alicates Circlips / Circlips pliers	
11	66400, 66401, 66403, 66407, 66408, 66439, 66440, 66441, 66457, 66458, 66459	Destornilladores mecánicos, Phillips®, Pozidriv® / Slotted, Phillips®, Pozidriv® screwdrivers	-
10	66475, 66476, 66477, 66478, 66479, 66480, 66481, 66482, 66483, 66484	Destornilladores Torx® / Torx® screwdrivers	
12	60341, 60342, 60343, 60344, 60345, 60347, 60348, 60349, 60351, 60352, 60353, 60354	Llaves combinadas / Combination wrenches	
8	60302, 60303, 60304, 60306, 60309, 60310, 60311, 60312	Llaves fijas / Open-end wrenches	inch
	60382, 60383, 60384, 60385, 60386, 60389, 60390, 60391	Llaves acodadas / Double offset ring wrenches	
17	61798	Juego llaves vaso / Socket wrench set	1/2", inch
10	65318, 65319, 65320, 65321, 65322, 65323, 65324, 65325, 65326, 65327	Llaves hexagonales / Hexagonal keys	
3	63402, 63404, 63406	Botadores / Punches	
1	63179	Cortafíos / Chisel	
4	62332, 62343, 62344, 62349	Alicates / Pliers	-
1	62135	Tenazas de canal / Box joint pincers	
	61112	Llave ajustable / Adjustable wrench	
2	62587, 62590	Extractores / Gear pullers	
1	62963	Llave dinamométrica reversible / Reversible torque wrench	1/2", 40-200 nm
4	69619, 69622, 69614, 69750	Martillos / Hammers	
1	62178	Tenazas Grip / Grip pincers	
3	63498, 63570, 63678	Limas / Files	
	62233	Tijera de chapa / Tin snip	
	65362	Flexómetros / Measuring tape	3 m/10'
1	65595	Recogedor telescópico / Telescopic joing pick up	
	69501	Cutter	

## ■ 102 PCS.



## ■ MM

COD.	PCS.		
69398	102	51012	17
PCS.	Composición / Composition / Composition	Descripción / Description / Description	
25	61960	Juego / Set	1/2", 25 pcs
12	69795	Juego llaves fijas / Open end wrenches set	12 pcs
	69278	Juego llaves combinadas / Combination wrenches set	6/7/8/9/10/11/12/13/14/15/16/17
10	61500	Juego llaves Allen / Allen keys wrenches Set	1,5/2/2,5/3/4/5/5,5/6/8/10, hex.
2	61110, 61113	Llaves ajustables Unique / Unique adjustable wrenches	6"/12"
5	66877, 66878, 66879, 66881, 66882	Destornilladores mecánico Rotork / Rotork slotted screwdriver	
	66898, 66899, 66900	Destornilladores Phillips® Rotork / Phillips® Rotork screwdrivers	
3	66908, 66909, 66910	Destornilladores Pozidriv® Rotork / Pozidriv® Rotork screwdrivers	
	66921, 66923, 66926	Destornilladores Torx® Rotork / Rotork Torx® screwdrivers	
	66937, 66938, 66939	Destornilladores carroceros Rotork / Rotork Stubby screwdrivers	
1	62332	Alicate universal Titacrom® Bimat / Titacrom® Bimat combination pliers	
	62337	Alicate b/plana Titacrom® Bimat / Titacrom® Bimat flat nose pliers	
	62338	Alicate b/redonda Titacrom® Bimat / Titacrom® Bimat round nose pliers	
	62341	Alicate telefonista b/curva Titacrom® Bimat / Titacrom® Bimat bent nose pliers	
	62343	Alicate c/diagonal Titacrom® Bimat / Titacrom® Bimat cutting pliers	
1	62445	Tenaza Pico Loro Bimat / Bimat groove joint	
	62231	Tenaza Grip recta / Straight grip pliers	
	62183	Alicate Circlips exterior recto / External straight Circlips pliers	
	62182	Alicate Circlips exterior curvo / External bent Circlips pliers	
	62181	Alicate Circlips interior recto / Internal straight Circlips pliers	
	62180	Alicate Circlips interior curvo / Internal bent Circlips pliers	
	63748	Arco de sierra / Hack Saw	
10	64435	Hojas de sierra acero al carbono / Carbon steel hacksaw blade	24 TPI
1	69604	Martillo ebanista / Joiners hammer	
	55326	Martillo de nylon / Nylon hammer	



## ■ 57 PCS.



## ■ INCH

COD.	PCS.		Medidas en / Sizes in / Mesures en	
<b>68990</b>		-		9
<b>68991</b>	57	51011	inch	34
PCS.	Composición / Composition / Composition	Descripción / Description / Description		
1	62213	Alicates Circlips / Circlips pliers		
11	66400, 66401, 66403, 66407, 66408, 66439, 66440, 66441, 66457, 66458, 66459	Destornilladores mecánicos, electricistas, Phillips®, Pozidriv® / Slotted, electrician, Phillips®, Pozidriv® screwdrivers		
12	60341, 60342, 60343, 60344, 60345, 60347, 60348, 60349, 60351, 60352, 60353, 60354	Llaves combinadas / Combination wrenches		
17	61798	Juego llaves vaso / Socket wrench set		
7	65320, 65321, 65322, 65323, 65324, 65325, 65326	Llaves hexagonales / Hexagonal keys		
1	62963	Llave dinamométrica reversible / Reversible torque wrench		
3	62332, 62343, 62344	Alicates / Pliers		
1	62135	Tenazas de canal / Box joint pincers		
1	61112	Llave ajustable / Adjustable wrench		
2	69622, 69614	Martillos / Hammers		
1	69534	Tijera electricista / Electrician's scissors		



## ■ 53 PCS.

## ■ MM

COD.	PCS.		Medidas en / Sizes in / Mesures en	
<b>68988</b>		-		8
<b>68989</b>	53	51011	mm	33
PCS.	Composición / Composition / Composition	Descripción / Description / Description		
1	62213	Alicates Circlips / Circlips pliers		
7	66401, 66403, 66407, 66439, 66440, 66457, 66458	Destornilladores mecánicos, electricistas, Phillips®, Pozidriv® / Slotted, electrician, Phillips®, Pozidriv® screwdrivers		
12	61725, 61726, 61727, 61728, 61729, 61730, 61731, 61732, 61733, 61734, 61735, 61736	Llaves combinadas / Combination wrenches		
17	61796	Juego llaves vaso / Socket wrench set		
7	61504, 61505, 61506, 61508, 61509, 61510, 65307	Llaves hexagonales / Hexagonal keys		
1	62963	Llave dinamométrica reversible / Reversible torque wrench		
3	62332, 62343, 62344	Alicates / Pliers		
1	62135	Tenazas de canal / Box joint pincers		
1	61112	Llave ajustable / Adjustable wrench		
2	69622, 69614	Martillos / Hammers		
1	69534	Tijera electricista / Electrician's scissors		





■ 47 PCS.

■ MM



COD.	PCS.		Medidas en / Sizes in / Mesures en	
68992		-		16
68993	47	51011	mm	41

PCS.	Composición / Composition / Composition	Descripción / Description / Description	
12	69251	Juego llaves fijas / Open end wrenches set 6x7 - 8x9 - 10x11 - 12x13 - 14x15 - 16x17 - 18x19 - 20x22 - 21x23 - 24x27 - 25x28 - 30x32 mm	
2	63178, 63179	Cortafíos / Chisel	160-200
	61112	Llave ajustable / Adjustable wrench	10"
	63172	Cortatubos acero / Steel tube cutter	2"
	63119	Cortatubos de cobre Unique / Tube cutter Unique	-
	61004	Llave Stillson / Stillson pipe wrench	14"
	61465	Llave Blitz / Blitz Wrench	175
1	62133	Tenaza de canal / Box joint	10"
	62233	Tijera para chapa / Tin snip	12"
	62172	Tenaza Grip boca curva / Curved jaw grip plier	10"
	69534	Tijera electricista / Electrician's scissors	
	62333	Alicate universal Titacrom® / Titacrom® Combination pliers	180
5	66400, 66401, 66403, 66405, 66407	Destornilladores Mastertork / Mastertork Screwdrivers	3x80 - 4x100 - 5,5x125 - 6,5x150 - 8x200
2	66439, 66440		PH1 - PH2
	69619	Martillo mecánico alemán / German type machinist's hammer	300 g
	65172	Flexómetro Rallye II / Rallye II Measuring tape	3 m/16 mm
	63570	Lima media caña entrefina / Medium half round file	
1	63678	Lima redonda entrefina / Medium round file	8"
	65293	Nivel trapezoidal profesional / Professional bridge type spirit level	400 mm
	63748	Arco de sierra / Hack Saw	-
	68003	Abocinador / Pulg flaring tool	mm
	61480	Llave de correa / Strap wrench	450 mm
8	68172	Set curvatubos carraca / Ratchet tube bender set	mm



## ■ 26 PCS.

## ■ MM

COD.	PCS.		
<b>69538</b>	26	51013	4,5

  

PCS.	COD.	PCS.	Descripción / Description / Description	
	61112		Llave ajustable Unique Plus Titacrom® / Unique Plus Titacrom® Adjustable wrench	10"
1	62479		Alicate universal Mastercut / Mastercut Combination pliers	210 mm
	62499		Alicate telefonista Mastercut / Mastercut Long nose pliers	200 mm
	62343		Alicate corte diagonal / Diagonal cutting plier	160 mm
10	61496		Set Allen punta bola / Long pattern ballpoint Allen set	-
	66401			4x100
	66403		Destornillador mecánico / Slotted screwdriver	5,5x125
	66405			6,5x150
	66406			8x150
	66439		Destornillador Phillips® / Phillips® screwdriver	PH1
	66440			PH2
	66457		Destornillador Pozidriv® / Screwdriver Pozidriv®	PZ1
	66458			PZ2
	69613		Martillo de bola / Ball pein hammer	425 g
63326		Cinzel / Flat chisel	23x200	
63748		Arco de Sierra / Hack Saw	-	
62850		Cortafíos / Chisel	20x200	



## ■ 26 PCS.

## ■ MM

COD.	PCS.	
<b>51620</b>	26	6,9



PCS.	COD.	PCS.	Descripción / Description / Description	
	62450		Alicate universal bimat / Combination plier bimat	
	62339		Alicate telefonista Titacrom® / Long nose plier titacrom® bimat	160 mm
	62459		Alicate corte diagonal bimat / Diagonal cutting plier bimat	
	62411		Tenaza pico loro automática / Auto grip groove joint plier	8"
1	61229		Llave ajustable de gran apertura Titacrom® / Wide opening adjustable wrench Titacrom®	6"
	66886			3x60
	66888		Destornillador electricista Rotork / Electrician screwdriver Rotork	4x125
	66890			5x150
	66898		Destornillador Phillips® Rotork / Screwdriver Phillips® Rotork	PH-1
	66908		Destornillador pozidriv Rotork / Screwdriver pozidriv Rotork	PZ-1
10	61500		Juego 10 llaves allen / Set of 10 hexagonal key wrenches	1,5-10
	65172		Flexómetro Rallye II / Rallye II Measuring tape	3M/16MM
	66909		Destornillador pozidriv Rotork / Screwdriver pozidriv Rotork	PZ-2
	66899		Destornillador Phillips® Rotork / Screwdriver Phillips® Rotork	PH-2
1	69614		Martillo bola madera / Ball pein hammer	
	61405		Llave mastergrip / Mastergrip wrench	10"
	69534		Tijera electricista / Electrician scissors	145 mm
	51010		Maleta porta-herramientas / Tool case	



**JUEGOS FONTANERÍA Y AIRE ACONDICIONADO / PLUMBING AND CONDITIONED AIR SETS / SETS PLOMBERIE ET AIR CONDITIONNEE / WERKZEUG SETS FÜR KLEMPNER UND KLIMATECHNIK / KIT PER IDRAULICA E CONDIZIONAMENTO / JOGOS DE CANALIZAÇÃO E AR CONDICIONADO / НАБОРЫ ДЛЯ КОНДИЦИОНИРОВАНИЯ И ДЛЯ САНТЕХНИКИ**

114 PCS.



MM

COD.	PCS.		
<b>69393</b>	114	51012	19,5
PCS.	Composición / Composition / Composition	Descripción / Description / Description	
12	69795	Juego llaves fijas / Open end wrenches set	12 pcs
10	69256	Juego llaves acodadas / Double offset wrenches set	10 pcs
1	61113	Llave Ajustable Unique Titacrom® / Unique Titacrom® adjustable wrench	12"
29	61958	Juego / Set	1/4", 29 pcs
2	61305, 61306	Llaves de vaso de doble articulación / Double ended swivel	16-17/18-19
10	61500	Juego llaves Allen / Allen keys wrenches Set	1,5/2/2,5/3/4/5/5,5/6/8/10, hex.
5	66874, 66876, 66878, 66880, 66881	Destornilladores mecánicos Rotork / Rotork slotted screwdrivers	
	76651, 76653, 76654	Destornilladores varilla protegida Rotork / Rotork Insulated screwdrivers	
3	76655, 76656, 76657	Destornilladores varilla protegida Phillips® Rotork / Rotork Phillips® insulated screwdrivers	
	76659, 76660, 76661	Destornilladores varilla protegida Pozidriv® Rotork / Rotork Pozidriv® insulated screwdrivers	
4	66920, 66921, 66922, 66923	Destornilladores Torx® Microtronic / Torx® Microtronic screwdrivers	
3	66937, 66938, 66939	Destornilladores carroceros Rotork / Rotork Stubby screwdrivers	
	66071	Destornillador buscapolos / Voltage tester screwdriver	
	61011	Llave sueca / Swedish pipe wrench	S-45°
1	61035	Llave de cadena reversible / Reversible chain pipe wrench	-
	63105	Cortatubos Telescopico / Telescopic tube cutter	32
6	68052	Kit frigorifista / Refrigeration Kit	
1	63748	Arco de sierra / Hack Saw	
10	64435	Hojas de sierra acero al carbono / Carbon steel hacksaw blade	
	69501	Cutter	
	69604	Martillo ebanista / Joiners hammer	
	62332	Alicate universal Titacrom® Bimat / Titacrom® Bimat combination pliers	
	62342	Alicate telefonista b/curva Titacrom® Bimat / Titacrom® Bimat bent nose pliers	
1	62344	Alicate cortaalambres Titacrom® Bimat Heavy Duty / Titacrom® Bimat, Heavy Duty cutting knippers	
	62349	Alicate pelacables Bimat / Bimat wirestripper pliers	
	62297	Tenaza canal Bimat Box / Bimat Box joint pliers	
	62178	Tenaza Grip Curva / Curved Grip pliers	



## ■ 68 PCS.

## ■ MM



COD.	PCS.		
69397	68	51012	19
PCS.	Composición / Composition / Composition	Descripción / Description / Description	
12	69795	Juego llaves Fijas / Open end wrenches set	12 pcs
	61935	Llave Combi Alavasa ajustable / Basque adjustable wrench combi	12"
1	61004	Llave Stillson / Stillson pipe wrench	14"
	61041	Llave Sueca / Swedish pipe wrench	45°, 1"
	61035	Llave de cadena reversible / Reversible chain pipe wrench	
10	61500	Juego llaves Allen / Allen keys wrenches Set	1,5/2/2,5/3/4/5/5,5/6/8/10, hex.
1	61009	Llave de lavabo / Basin Wrench	
5	66875, 66877, 66879, 66881, 66882	Destornilladores mecánico Rotork / Rotork slotted screwdriver	
3	66898, 66899, 66900	Destornilladores Phillips® Rotork / Phillips® Rotork screwdrivers	
2	66909, 66910	Destornilladores Pozidriv® Rotork / Pozidriv® Rotork screwdrivers	
4	66921, 66923, 66926, 66927	Destornilladores Torx® Rotork / Rotork Torx® screwdrivers	
	62333	Alicate universal Titacrom® Bimat / Titacrom® Bimat combination pliers	-
	62344	Alicate cortaalambres Titacrom® Bimat Heavy Duty Knippers / Titacrom® Bimat Heavy Duty Knippers cutting pliers	
	62172	Tenaza Grip Curva / Curved Grip pliers	
	62294	Tenaza canal Titacrom® Box / Titacrom® Box Joint pliers	
1	62123	Tenaza rusa Titacrom® / Titacrom® Tower pincer	
	63170	Cortatubos Classic / Classic Tube cutter	32
	63171	Cortatubos acero / Steel tube cutter	1 1/4"
	63200	Tijera para tubo de plástico / Plastic pipe cutter	
	62159	Tijera cortachapa / Tin Snip	-
	63748	Arco de Sierra / Hack Saw	
10	64435	Hojas de sierra acero al carbono / Carbon steel hacksaw blade	24 dientes / 24 teeth
	69620	Martillo alemán / German type machinist's hammer	
1	69605	Maceta / Stoning hammer	
	68003	Abocinador / Pulg flaring tool	
	69505	Desatascador de muelle / Spring pipe cleaner	
3	68043, 68045, 68054	Muelles curvatubos / Sping tube benders	10-14-18





■ 24 PCS.

■ MM



COD.	PCS.			
<b>69537</b>	24	51013	8,0	
PCS.	COD.	PCS.	Descripción / Description / Description	
	61934		Llave ajustable Alavesa combi / Basque Combi adjustable wrench	10"
	61017		Llave Heavy Duty / Heavy Duty pipe wrench	14"
1	63172		Cortatubos acero / Steel tube cutter	2"
	62479		Alicate universal Mastercut / Mastercut Combination pliers	210 mm
	62499		Alicate telefonista Mastercut / Mastercut Long nose pliers	200 mm
	62343		Alicate corte diagonal / Diagonal cutting plier	160 mm
10	61496		Set Allen punta bola / Long patern ballpoint Allen set	-
	66401			4x100
	66403			5,5x125
	66405		Destornillador mecánico / Slotted screwdriver	6,5x150
	66406			8x150
1	66439		Destornillador Phillips® / Phillips® screwdriver	PH1
	66440			PH2
	63119		Cortatubos Unique / Unique tube cutter	42
	63748		Arco de Sierra / Hack Saw	-



# EGGA Master

## ART IN INNOVATION



**JUEGOS ELECTRICIDAD / ELECTRICIAN SETS / SETS ÉLECTRICIENS / WERKZEUGSÄTZE FÜR ELEKTRIZITÄT / KIT ELETTRICISTI / JOGOS ÉTRICIDADE / НАБОР ЭЛЕКТРИКА**
**99 PCS.**
**MM**

COD.	PCS.		
<b>69390</b>	99	51010	8,0
PCS.	Composición / Composition / Composition	Descripción / Description / Description	
29	61958	Juego / Set	1/4", 29 pcs
6	69248	Juego de llaves fijas / Open end wrenches set	6-7/8-9/10-11/12-13/14-15/16-17
1	61110	Llave ajustable Unique Plus Titacrom® / Unique Plus Titacrom® Adjustable wrench	6"
4	66846, 66847, 66848, 66849	Destornilladores boca plana Microtronic / Microtronic flat nose screwdrivers	
3	66850, 66851, 66852	Destornilladores Phillips® Microtronic / Phillips® Microtronic screwdrivers	
2	66853, 66854	Destornilladores Pozidriv® Microtronic / Pozidriv® Microtronic screwdrivers	-
5	66855, 66856, 66857, 66858, 66859	Destornilladores Torx® Microtronic / Torx® Microtronic screwdrivers	
4	57684, 57685, 66864, 66865	Destornilladores hexagonales Microtronic / Microtronic hexagonal screwdrivers	
3	76651, 76652, 76653	Destornilladores varilla protegida Rotork / Rotork Insulated screwdrivers	
2	76655, 76656	Destornilladores varilla protegida Phillips® Rotork / Rotork Phillips® insulated screwdrivers	1000V
	76659, 76660	Destornilladores varilla protegida Pozidriv® Rotork / Rotork Pozidriv® insulated screwdrivers	
3	66928, 66929, 66930	Destornilladores punta esfera Rotork Phillips® / Rotork Phillips® ball tip screwdrivers	
	66917, 66918, 66919	Destornilladores Torx® Rotork / Rotork Torx® screwdrivers	-
1	66070	Destornillador buscapolos / Voltage tester screwdriver	
8	61499	Juego llaves Allen / Allen keys wrenches Set	1,5/2/2,5/3/4/5/5,5/6, hex.
5	61870, 61871, 61872, 61873, 61874	Llaves de pipa / Angled sockets	6/7/8/9/10
4	61824, 61825, 61826, 61827	Llaves de tubo doble boca / Socket double ended wrench	6.7/8-9/10-11/12-13
	62241	Alicate mini universal Titacrom® Bimat / Titacrom® Bimat combination electronic pliers	
1	62242	Alicate mini b/plana Titacrom® Bimat / Titacrom® Bimat flat nose electronic pliers	
	62243	Alicate mini b/redonda Titacrom® Bimat / Titacrom® Bimat round nose electronic pliers	
	62244	Alicate mini telefonista Titacrom® Bimat / Titacrom® Bimat long nose electronic pliers	
	62245	Alicate mini b/curva Titacrom® Bimat / Titacrom® Bimat bent nose electronic pliers	
	62246	Alicate mini b/aguja Titacrom® Bimat / Titacrom® Bimat long needle nose electronic pliers	
	62247	Alicate mini c/diagonal Titacrom® Bimat / Titacrom® Bimat diagonal cutting electronic pliers	
	62249	Alicate mini c/frontal Titacrom® Bimat / Titacrom® Bimat end cutter electronic pliers	
4	69529	Set 4 pinzas / Set 4 tweezers	
1	69501	Cutter	
	69601	Martillo ebanista / Joiners hammer	



■ 84 PCS.

■ MM

COD.	PCS.		
69391	84	51010	11



  

PCS.	Composición / Composition / Composition	Descripción / Description / Description		
29	61958	Juego / Set	1/4", 29 pcs	
8	69249	Juego de llaves fijas / Open end wrenches set	6-7/8-9/10-11/12-13/14-15/16-17/18-19/20-22	
10	61615, 61616, 61617, 61618, 61619, 61620, 61621, 61622, 61623, 61624	Llaves Allen p/bola / Keys Wrenches	1,5/2/2,5/3/4/5/5,5/6/8/10, hex.	
4	76651, 76652, 76653, 76654	Destornilladores varilla protegida Rotork / Rotork Insulated screwdrivers	1000V	
	76655, 76656, 76657, 76658	Destornilladores varilla protegida Phillips® Rotork / Rotork Phillips® insulated screwdrivers		
	76659, 76660, 76661, 76662	Destornilladores varilla protegida Pozidriv® Rotork / Rotork Pozidriv® insulated screwdrivers		
	66070	Destornillador buscapolos / Voltage tester screwdriver		-
	76552	Llave ajustable Titacrom® / Titacrom® Adjustable wrench	10", 1000V	
1	76584	Alicate universal / Combination pliers	1000V	
	76589	Alicate b/plana / Flat nose pliers		
	76590	Alicate b/redonda / Round nose pliers		
	76591	Alicate telefonista / Long nose plier		
	76593	Alicate telefonista b/curva / Titacrom® bent nose pliers		
	76595	Alicate c/diagonal / Diagonal cutting pliers		
	76603	Alicate pelacables / Wirestripper		
	62445	Tenaza Pico Loro Bimat / Bimat groove joint		-
	62178	Tenaza Grip / Grip plier		7"
	62151	Tenaza cortacables / Cable cutters		-
	69501	Cutter	-	
	63748	Arco de sierra / Hack saw	-	
10	64435	Hojas de sierra acero al carbono / Carbon steel hacksaw blade	24 dientes / 24 teeth	
1	69603	Martillo ebanista / Joiners hammer	-	



## ■ 52 PCS.

## ■ MM

COD.	PCS.		Medidas en / Sizes in / Mesures en	
<b>76686</b>		-		6,0
<b>76687</b>	52	51011	mm	31



  

PCS.	Composición / Composition / Composition	Descripción / Description / Description	
8	76584, 76590, 76592, 76591, 76593, 76594, 76595, 76603	Alicates / Pliers	
1	73008	Tenaza cortacables / Cable cutters	
2	73040, 73041	Pinzas / Tweezers	
	73035, 73036	Cuchillos / Knives	
	73011	Cortacables de carraca / Ratchet electrician cable cutter	1000V
1	73005	Tenazas de canal / Box joint pincers	
	76552	Llave ajustable / Adjustable wrench	
8	73064, 73065, 73066, 73067, 73068, 73071, 73073, 73076	Llaves fijas una boca / Single ended open jaw spanner	
	69534	Tijera electricista / Electrician's scissors	
1	62494	Alicate para terminales / Terminals plier	-
	51257	Tester	
6	76621, 76622, 76624, 76625, 76626, 76627	Destornilladores electricistas / Electrician screwdrivers	1000V
5	76628, 76629, 76630, 76631, 76632	Destornilladores Phillips® / Phillips® screwdriver	
	63254	Soldador de estaño / Tin soldering iron	
1	63256	Succionador con boquilla antiestática para soldadura / Desoldering pump with anti-static rubber nozzle	-
	65587	Espejo articulado / Joint telescopic mirror	
6	73232, 73233, 73234, 73236, 73238, 73239	Vasos / Sockets	
1	73245	Alargadera / Extension	1000V
	73687	Carraca / Ratchet	
3	73251, 73252, 73253	Boquillas hexagonales / Hexagonal sockets	



## ■ 37 PCS.

## ■ MM



COD.	PCS.		Medidas en / Sizes in / Mesures en	
<b>79066</b>	37	51054	mm	9

PCS.	Composición / Composition / Composition	Descripción / Description / Description	
4	76583, 76603, 76592, 76599	Alicates / Pliers	
1	73008	Cortacables / Cable cutters	
6	73064, 73067, 73068, 73071, 73073, 73076	Llaves fijas una boca / Single ended open jaw spanner	1000V
	73122, 73125, 73126, 73129, 73131, 73134	Llaves de estrella / Ring wrenches	
1	73683	Carraca / Ratchet	
2	73446, 73445	Alargadera / Extension	3/8" - 1000V
1	73448	Mango en T / T Handle	1000V
9	74962, 74963, 74964, 74965, 74966, 74969, 74971, 74974, 74976	Vasos / Sockets	1/2" - 1000V
2	73035, 73036	Cuchillos / Knives	
1	73040	Pinza de plástico / Plastic tweezers	1000V
4	76621, 76622, 76623, 76625	Destornilladores electricistas / Electrician screwdrivers	







COD.	PCS.		Medidas en / Sizes in / Mesures en	
<b>76688</b>		-		3,0
<b>76689</b>	37	51010	mm	7,0
PCS.	Composición / Composition / Composition	Descripción / Description / Description		
5	76584, 76591, 76593, 76595, 76603	Alicates / Pliers		
	73008	Tenaza cortacables / Cable cutters		
1	73040	Pinzas / Tweezers		
	73035	Cuchillos / Knives		1000V
	73005	Tenazas de canal / Box joint pincers		
5	73064, 73065, 73067, 73068, 73070	Llaves fijas una boca / Single ended open jaw spanner		
1	69534	Tijera electricista / Electrician's scissors		
	51257	Tester		-
5	76621, 76622, 76624, 76625, 76626	Destornilladores electricistas / Electrician screwdrivers		1000V
3	76629, 76630, 76631	Destornilladores Phillips® / Phillips® screwdriver		
	63254	Soldador de estaño / Tin soldering iron		
1	63256	Succionador con boquilla antiestática para soldadura / Desoldering pump with anti-static rubber nozzle		-
6	73232, 73233, 73234, 73236, 73238, 73239	Vasos / Sockets		
1	73245	Alargadera / Extension		1000V
	73246	Carraca / Ratchet		



### 27 PCS.



#### INCH

COD.	PCS.		Medidas en / Sizes in / Mesures en	
<b>79065</b>	27	51054	inch	8
PCS.	Composición / Composition / Composition	Descripción / Description / Description		
3	76583, 76597, 76592	Alicates / Pliers		
	76621, 76623, 76625	Destornilladores electricistas / Electrician screwdrivers		1000V
2	76629, 76630	Destornilladores Phillips® / Phillips® screwdriver		
1	73685	Carraca / Ratchet		-
2	73280, 73281	Alargadera / Extension		
	75162, 75163, 75164, 75165, 75167, 75168, 75169, 75170	Vasos / Sockets		3/8" - 1000V
8	73349, 73350, 73351, 73352, 73353, 73354, 73355, 73356	Llaves de estrella acodada una boca / Offset ring wrenches		1000V



### 26 PCS.



#### MM

COD.	PCS.		Medidas en / Sizes in / Mesures en	
<b>79064</b>	26	51033	mm	5
PCS.	Composición / Composition / Composition	Descripción / Description / Description		
7	76583, 76603, 76592, 76594, 76595, 76590, 76589	Alicates / Pliers		
2	73156, 73158	Llaves hexagonales / Hexagonal keys		
5	76621, 76622, 76623, 76625, 76626	Destornilladores electricistas / Electrician screwdrivers		
	76629, 76630	Destornilladores Phillips® / Phillips® screwdriver		1000V
	76634, 76635	Destornilladores Pozidriv® / Pozidriv® screwdrivers		
4	74700, 74701, 74702, 74703	Destornilladores de vaso / Socket screwdriver		
2	73035, 73036	Cuchillos / Knives		
	73008	Cortacables / Cable cutters		
1	66073	Buscapolos / Voltage tester		-



## ■ 20 PCS.



## ■ MM

COD.	PCS.			
<b>69536</b>	20	51013	4,0	
PCS.	COD.	PCS.	Descripción / Description / Description	
	76609		Alicates universales Mastercut / Mastercut combination pliers	1000V, 210 mm
	76595		Alicate corte diagonal / Diagonal cutting plier	
	76591		Alicates telefonista recto / Long nose pliers	1000V, 160 mm
	76603		Alicate pelacables / Wirestripper	
	62494		Alicate para terminales / Terminals plier	220 mm
	76622		Destornillador electricista / Electrician screwdriver	1000V, 4x125
	76625		Destornillador Phillips® / Phillips® screwdriver	1000V, 6,5x150
	76629		Destornillador Phillips® / Phillips® screwdriver	1000V, PH1
	76630		Destornillador Phillips® / Phillips® screwdriver	1000V, PH2
1	66422		Destornillador electricista / Electrician screwdriver	3 x 100
	66423		Destornillador electricista / Electrician screwdriver	4 x 125
	66425		Destornillador electricista / Electrician screwdriver	5,5 x 150
	66426		Destornillador electricista / Electrician screwdriver	6,5 x 150
	66427		Destornillador electricista / Electrician screwdriver	8 x 175
	66073		Buscapolos / Voltage tester	-
	73035		Cuchillo / Knife	1000V
	69662		Maceta modelo español / Spanish type stoning hammer	1000 g
	69534		Tijera electricista / Electrician's scissors	145 mm
	65167		Flexómetro robust magnet / Robust Magnet Measuring tape	5 x 25
	63748		Arco de sierra / Hack Saw	-



## ■ 17 PCS.



## ■ MM

COD.	PCS.		Medidas en / Sizes in / Mesures en	
<b>79063</b>	17	51033	mm	3,6
PCS.	Composición / Composition / Composition	Descripción / Description / Description		
6	76584, 76599, 76592, 76603, 76589, 76590	Alicates / Pliers	1000V	
1	66073	Buscapolos / Voltage tester	-	
6	76620, 76621, 76623, 76625, 76626, 76627	Destornilladores electricistas / Electrician screwdrivers	1000V	
2	76629, 76630	Destornilladores Phillips® / Phillips® screwdriver	1000V	
	73035, 73036	Cuchillos / Knives		



## ■ 16 PCS.



## ■ MM

COD.	PCS.		Medidas en / Sizes in / Mesures en	
<b>76690</b>		-		2,0
<b>76691</b>	16	51013	mm	4,0
PCS.	Composición / Composition / Composition	Descripción / Description / Description		
3	76584, 76591, 76595	Alicates / Pliers		
1	73040	Pinzas / Tweezers	1000V	
	73035	Cuchillos / Knives		
3	73064, 73067, 73070	Llaves fijas una boca / Single ended open jaw spanner		
1	69534	Tijera electricista / Electrician's scissors	-	
	66071	Buscapolos / Voltage tester		
4	76621, 76622, 76625, 76626	Destornilladores electricistas / Electrician screwdrivers	1000V	
2	76629, 76630	Destornilladores Phillips® / Phillips® screwdriver		





## ■ 10 PCS.

## ■ MM

COD.	PCS.		Medidas en / Sizes in / Mesures en	
<b>79061</b>	10	51033	mm	3
PCS.	Composición / Composition / Composition		Descripción / Description / Description	
4	76583, 76594, 76603, 76595		Alicates / Pliers	
3	76621, 76623, 76626		Destornilladores electricistas / Electrician screwdrivers	
2	76634, 76635		Destornilladores Pozidriv® / Pozidriv® screwdrivers	
1	73004		Tenaza de canal / Box joint	





COD.	PCS.		Medidas en / Sizes in / Mesures en	
<b>79062</b>	10	51033	mm	2,5
PCS.	Composición / Composition / Composition		Descripción / Description / Description	
4	76583, 76603, 76590, 76599		Alicates / Pliers	
1	66073		Buscapolos / Voltage tester	
4	76621, 76622, 76623, 76625		Destornilladores electricistas / Electrician screwdrivers	
1	76629		Destornilladores Phillips® / Phillips® screwdriver	



## ■ 5 PCS.

## ■ MM



COD.	PCS.		Medidas en / Sizes in / Mesures en	
<b>79060</b>	5	51033	mm	1,2
PCS.	Composición / Composition / Composition		Descripción / Description / Description	
4	76583, 76594, 76603, 76595		Alicates / Pliers	
1	73004		Tenaza de canal / Box joint	



# EGAMaster

## ART IN INNOVATION

**ELECTROMECÁNICA / ELECTROMECHANICAL KIT / KIT ELECTROMÉCANIQUE / WERKZEUGSET FÜR ELEKTROMECHANIK / ELETTROMECCANICA / ELECTROMECÂNICA / ЭЛЕКТРОМЕХАНИЧЕСКИЙ НАБОР**
**102 PCS.**
**MM**



COD.	PCS.		
<b>69392</b>	102	51010	10
PCS.	Composición / Composition / Composition	Descripción / Description / Description	
29	61958	Juego / Set	1/4", 29 pcs
10	69277	Juego llaves combinadas / Combination wrenches set	10 pcs
1	61908	Llave ajustable Unique Plus Titacrom® Comfort / Unique Plus Titacrom® Comfort adjustable wrench	10"
4	76651, 76652, 76653, 76654	Destornilladores varilla protegida Rotork / Rotork Insulated screwdrivers	
	76655, 76656, 76657	Destornilladores varilla protegida Phillips® Rotork / Rotork Phillips® insulated screwdrivers	
3	76659, 76660, 76661	Destornilladores varilla protegida Pozidriv® Rotork / Rotork Pozidriv® insulated screwdrivers	
	66928, 66929, 66930, 66931, 66932	Destornilladores punta esfera Rotork / Rotork ball tip screwdrivers	
5	66917, 66918, 66919, 66920, 66921	Destornilladores Torx® Rotork / Rotork Torx® screwdrivers	
2	66934, 66935	Destornilladores Robertson Rotork / Rotork Robertson screwdrivers	
1	66071	Destornillador buscapolos / Voltage tester screwdriver	
5	61824, 61825, 61826, 61827, 61828	Llaves de tubo doble boca / Socket double ended wrench	6-7/8-9/10-11/12-13/14-15
8	61499	Juego llaves Allen / Allen keys wrenches Set	1,5/2/2,5/3/4/5/5,5/6, hex.
	62177	Tenaza Grip curva / Curved Grip pliers	
	62331	Alicate universal Titacrom® Bimat / Titacrom® Bimat combination pliers	
	62337	Alicate b/plana Titacrom® Bimat / Titacrom® Bimat flat nose pliers	
	62339	Alicate telefonista Titacrom® Bimat / Titacrom® Bimat long nose pliers	
	62341	Alicate telefonista b/curva Titacrom® Bimat / Titacrom® Bimat bent nose pliers	
	62343	Alicate corte diagonal Titacrom® Bimat / Titacrom® Bimat diagonal cutting pliers	
	62349	Alicate pelacables Titacrom® Bimat / Titacrom® Bimat wirestripper	
1	62445	Tenaza Pico Loro Bimat / Bimat groove joint	
	62214	Alicate Circlips exterior recto / External straight Circlips pliers	
	62218	Alicate Circlips exterior curvo / External bent Circlips pliers	
	62222	Alicate Circlips interior recto / Internal straight Circlips pliers	
	62226	Alicate Circlips interior curvo / Internal bent Circlips pliers	
	69603	Martillo ebanista / Joiners hammer	
	69531	Pinza / Tweezers	45°
	69533	Pinza b/plana / Flat nose tweezers	
	69532	Pinza autoapretante / Self adjusting tweezers	-
8	69433	Kit	8 pcs
1	69504	Magnetizador / Magnetizer	-
	69501	Cutter	-







■ 87 PCS.

■ MM

COD.	PCS.		
69394	87	51010	9,5
PCS.	Composición / Composition / Composition	Descripción / Description / Description	
29	61958	Juego / Set	1/4", 29 pcs
8	69249	Juego de llaves fijas / Open end wrenches set	8 pcs
9	61870, 61871, 61872, 61873, 61874, 61875, 61876, 61877, 61878	Llaves de pipa / Angled sockets	6/7/8/9/10/11/12/13/14
8	61499	Juego llaves Allen / Allen keys wrenches Set	1,5/2/2,5/3/4/5/5,5/6 hex.
1	61111	Llave ajustable Unique Titacrom® / Unique Titacrom® adjustable wrench	8"
	76651, 76652, 76653	Destornilladores varilla protegida Rotork / Rotork Insulated screwdrivers	
	76655, 76656, 76657	Destornilladores varilla protegida Phillips® Rotork / Rotork Phillips® insulated screwdrivers	
3	76659, 76660, 76661	Destornilladores varilla protegida Pozidriv® Rotork / Rotork Pozidriv® insulated screwdrivers	
	66917, 66918, 66919	Destornilladores Torx® Rotork / Rotork Torx® screwdrivers	
	66928, 66929, 66930	Destornilladores punta esfera Rotork / Rotork ball tip screwdrivers	
	66070	Destornillador buscapolos / Voltage tester screwdriver	
	62331	Alicate universal Titacrom® Bimat / Titacrom® Bimat combination pliers	
	62337	Alicate b/plana Titacrom® Bimat / Titacrom® Bimat flat nose pliers	
	62338	Alicate b/redonda Titacrom® Bimat / Titacrom® Bimat round nose pliers	
	62341	Alicate telefonista b/curva Titacrom® Bimat / Titacrom® Bimat bent nose pliers	
	62343	Alicate c/diagonal Titacrom® Bimat / Titacrom® Bimat cutting pliers	
	62349	Alicate pelacables Bimat / Bimat wirestripper pliers	
1	62445	Tenaza Pico Loro Bimat / Bimat groove joint	
	62177	Tenaza Grip curva / Curved Grip pliers	
	69531	Pinza / Tweezers	45°
	69530	Pinza b/fina / Neat tips tweezer	
	62242	Alicate mini b/plana Titacrom® Bimat / Titacrom® Bimat flat nose electronic pliers	
	62247	Alicate mini c/diagonal Titacrom® Bimat / Titacrom® Bimat diagonal cutting wlectronic pliers	
	62246	Alicate mini b/aguja Titacrom® Bimat / Titacrom Bimat long needle nose electronic pliers	
	63097	Cortatubos mini / Tube Cutter	22 mm
	69501	Cutter	
	69601	Martillo ebanista / Joiners hammer	





**MANTENIMIENTO DE EDIFICIOS / BUILDING MAINTENANCE / KIT POUR L'ENTRETIEN DE BÂTIMENT / WERKZEUGSATZ FÜR GEBÄUDEWARTUNG / EDILIZIA INDUSTRIALE / MANUTENÇÃO DE EDIFÍCIOS / НАБОР ДЛЯ ОБСЛУЖИВАНИЯ ЗДАНИЙ**
**227 PCS.**
**MM/INCH**

COD.	PCS.		Medidas en / Sizes in / Mesures en		
59155		-		-	26
59156	227	51075	mm/inch	-	74
59157				●	76

PCS.	Composición / Composition / Composition	Descripción / Description / Description	
4	62332, 62337, 62340, 62343	Alicates / Pliers	
1	63748	Arcos de sierra / Hack saws	
	61570	Cepillos / Brushes	
	67190, 67191	Destornilladores carroceros / Stubby screwdrivers	
2	66887, 66888	Destornilladores electricista / Electrician screwdrivers	mm
	66877, 66879	Destornilladores mecánicos / Slotted screwdrivers	
	66897, 66898	Destornilladores Phillips® / Phillips® screwdriver	
1	66731	Destornilladores portapuntas / Bitholder screwdrivers	
2	66908, 66909	Destornilladores Pozidriv® / Pozidriv® screwdrivers	
7	66921, 66922, 66923, 66924, 66925, 66926, 66927	Destornilladores Torx / Screwdrivers Torx	
1	65586	Espejo articulado / Joint telescopic mirror	
	65172	Flexómetros / Measuring tapes	
2	65552, 65560	Galgas / Gauges	
	61516	Juego llaves hexagonales / Set hexagonal key wrenches	
10	61495	Juego llaves hexagonales bola / Set hexagonal key wrenches ball type	inch
4	69529	Juego pinzas / Set tweezers	
10	66948	Juego puntas / Bits set	
35	55603	Juego vasos / Socket set	1/2"
42	61792	Juego vasos spline / Spline socket set	3/8"
29	55667	Juego vasos spline / Spline socket set	1/4"
11	63537, 63573, 63609, 63645, 63681, 63714, 63715, 63716, 63717, 63718, 63719	Limas / Files	
1	58641	Linternas / Flashlights	
	61113	Llaves ajustables / Adjustable wrenches	
12	60341, 60342, 60343, 60344, 60345, 60347, 60348, 60349, 60351, 60352, 60353, 60354	Llaves combinadas / Combination wrenches	inch
10	61727, 61728, 61729, 61730, 61731, 61732, 61733, 61736, 61738, 61741	Llaves de carraca reversible / Reversible ratchet handles	mm
1	62603	Llaves de vaso / Socket wrenches	1/4"
11	60420, 60421, 60422, 60423, 60424, 60425, 60426, 60427, 60428, 60429, 60430	Llaves para racores / Flare nut spanners	
6	60785, 60788, 60789, 60790, 60792, 60793	Martillos / Hammers	
2	55325, 69613	Recogedor telescópico / Telescopic joint pick up	
1	65589	Tenazas / Pincers	
2	62172, 62446	Tijeras / Tin snips	
1	62170	Tijeras / Tin snips	

## 73 PCS.

## MM

COD.	PCS.		
69395	73	51012	20
PCS.	Composición / Composition / Composition	Descripción / Description / Description	
8	69249	Juego de llaves fijas / Open end wrenches set	8 pcs
1	61113	Llave ajustable Unique Plus Titacrom® / Unique Plus Titacrom® Adjustable wrench	1/2"
8	61824, 61825, 61826, 61827, 61828, 61829, 61830, 61831	Llaves de tubo doble boca / Socket double ended wrench	-
10	61500	Juego llaves Allen / Allen keys wrenches Set	1,5/2/2,5/3/4/5/5,5/6/8/10, hex.
	62332	Alicate universal Titacrom® Bimat / Titacrom® Bimat combination pliers	
	62344	Alicate cortaalambres Titacrom® Bimat Heavy Duty / Titacrom® Bimat, Heavy Duty cutting knippers	
	62297	Tenaza canal Bimat / Bimat box joint pliers	
1	62172	Tenaza Grip curva / Curved Grip pliers	
	62349	Alicate pelacables Titacrom® Bimat / Titacrom® Bimat wirestripper	
	62124	Tenaza rusa Titacrom® / Titacrom® Tower pincer	
	61005	Llave Stillson / Stillson pipe wrench	18"
	63748	Arco de Sierra / Hack Saw	-
10	64435	Hojas de sierra acero al carbono / Carbon steel hacksaw blade	24 dientes / 24 teeth
	62159	Tijera cortachapa / Tin Snip	
	69501	Cutter	
	62151	Tenaza cortacables / Cable cutters	
1	69614	Martillo de bola / Ball pein hammer	
	69608	Martillo uña mod. americano / Mod. americano claw hammer	
	55326	Martillo de nylon / Nylon hammer	
	69520	Maceta goma / Rubber hammer	
5	66875, 66877, 66879, 66881, 66882	Destornilladores mecánico Rotork / Rotork slotted screwdriver	
	66908, 66909	Destornilladores Pozidriv® Rotork / Pozidriv® Rotork screwdrivers	
	76652, 76653	Destornilladores varilla protegida Rotork / Rotork Insulated screwdrivers	
2	76656, 76657	Destornilladores varilla protegida Phillips® Rotork / Rotork Phillips® insulated screwdrivers	
	66921, 66923	Destornilladores Torx® Rotork / Rotork Torx® screwdrivers	
1	66071	Destornillador buscapolos / Voltage tester screwdriver	
	63000	Carraca / Ratchet	
2	63003, 63004	Cabezas / Heads	
	69506	Desatascador de muelle / Spring pipe cleaner	
1	68058	Kit reparador de grifos / Valve reseater	
	67019	Paleta mod. Madrid / Madrid bricklayer	
	67021	Espátula / Scraper	



**JUEGOS PROFESIONALES DE MECÁNICA / PROFESSIONAL SETS FOR MECHANICS / SETS DE MÉCANICIENS PROFESSIONNELS / PROFESSIONAL WERKZEUGSETS FÜR MECHANIKER / SET PROFESSIONALI DI MECCANICA / JOGOS PROFISSIONAL DE MECÂNICA / НАБОР МЕХАНИКА**
**BASIC 39 PCS.**

COD.	PCS.	Utilizado en / Used in / Utilisé dans		Medidas en / Sizes in / Mesures en	
<b>51550</b>	39	Sur de Europa / Southern Europe / Le Sud d'Europe	50994	mm	6

**Composición / Composition / Composition**

65172, 69622, 61496, 66440, 66439, 66405, 66402, 66401, 62135, 61908, 61438, 66732, 61435, 61443, 61321, 61320, 61319, 61318, 61317, 61316, 61315, 61314, 61313, 63975, 61312, 63974, 61311, 62606, 62343, 62332

COD.	PCS.	Utilizado en / Used in / Utilisé dans		Medidas en / Sizes in / Mesures en	
<b>51553</b>	39	América / America / L'Amérique	50994	inch	6

**Composición / Composition / Composition**

60423, 65363, 69622, 61495, 66440, 66439, 55335, 55333, 55331, 62106, 61908, 62603, 60422, 60421, 60420, 66732, 61444, 61443, 61442, 61438, 61435, 60430, 60429, 60428, 60427, 60426, 60425, 60424, 62343, 62332

**ADVANCED 72 PCS.**

COD.	PCS.	Utilizado en / Used in / Utilisé dans		Medidas en / Sizes in / Mesures en	
<b>51551</b>	72	Sur de Europa / Southern Europe / Le Sud d'Europe	50995	mm	18

**Composición / Composition / Composition**

55326, 63681, 63645, 63609, 63573, 63537, 65158, 65172, 69622, 61496, 66053, 66052, 61741, 61738, 61736, 61733, 61732, 61731, 61730, 61729, 61728, 61727, 66442, 66441, 66440, 66439, 66408, 66407, 66405, 66402, 66401, 62135, 63915, 63399, 63398, 63397, 63396, 63395, 63394, 61908, 61437, 61458, 61455, 61816, 61815, 61814, 61813, 61811, 61810, 61809, 61808, 61807, 61806, 61805, 61804, 61803, 61802, 61801, 61800, 62606, 62343, 62339, 62332

COD.	PCS.	Utilizado en / Used in / Utilisé dans		Medidas en / Sizes in / Mesures en	
<b>51554</b>	72	América / America / L'Amérique	50995	inch	18

**Composición / Composition / Composition**

55326, 63681, 63645, 63609, 63573, 63537, 65158, 65363, 69622, 61495, 66053, 66052, 60354, 60352, 60351, 60349, 60348, 60347, 60345, 60344, 60343, 60342, 66442, 66441, 66440, 66439, 55338, 55337, 55335, 55333, 55331, 62106, 63915, 63399, 63398, 63397, 63396, 63395, 63394, 61908, 61437, 61458, 61455, 60474, 60473, 60472, 60471, 60470, 60469, 60468, 60467, 60459, 60466, 60465, 60464, 60463, 60462, 60461, 60460, 62606, 62343, 62339, 62332



■ MASTER 102-103 PCS.



COD.	PCS.	Utilizado en / Used in / Utilisé dans			Medidas en / Sizes in / Mesures en	
51552	103	Sur de Europa / Southern Europe / Le Sud d'Europe	50995, 50994	50986	mm	25

Composición / Composition / Composition

55326, 63396, 63299, 76732, 76654, 76652, 63573, 62848, 62847, 63436, 63416, 62871, 63681, 63645, 63609, 63537, 65158, 65172, 62824, 69622, 63876, 62170, 56567, 61496, 61741, 61738, 61736, 61733, 61732, 61731, 61730, 61729, 61728, 61727, 76735, 76658, 76657, 76656, 75178, 75177, 75176, 75175, 62707, 63915, 51257, 65480, 65603, 61908, 61444, 61438, 66732, 61435, 61443, 61321, 61320, 61319, 61318, 61317, 61316, 61315, 61314, 61313, 63975, 61312, 63974, 61311, 62603, 61437, 61458, 61455, 61816, 61815, 61814, 61813, 61811, 61810, 61809, 61808, 61807, 61806, 61805, 61804, 61803, 61802, 61801, 61800, 62606, 62097, 76595, 76591, 76683

COD.	PCS.	Utilizado en / Used in / Utilisé dans			Medidas en / Sizes in / Mesures en	
51555	102	América / America / L'Amérique	50995, 50994	50986	inch	25

Composición / Composition / Composition

55326, 63299, 62848, 62847, 63436, 63416, 62871, 63396, 63681, 63645, 63609, 63573, 63537, 65158, 65362, 62824, 69622, 63876, 62170, 56567, 61495, 60354, 60352, 60351, 60349, 60348, 60347, 60345, 60344, 60343, 60342, 76735, 76658, 76657, 76656, 75178, 75177, 75176, 75175, 62707, 63915, 51257, 65480, 65603, 61908, 61444, 61438, 66732, 61435, 61443, 60430, 60429, 60428, 60247, 60426, 60425, 60424, 60423, 60422, 60421, 60420, 62606, 61437, 61458, 61455, 60474, 60473, 60472, 60471, 60470, 60469, 60468, 60467, 60459, 60466, 60465, 60464, 60463, 60462, 60461, 60460, 62606, 62097, 76595, 76591, 76583

■ JUEGOS PROFESIONALES DE FONTANERÍA / PROFESSIONAL PLUMBING SETS / SETS PROFESSIONNELS POUR PLOMBERIE / PROFESSIONAL WERKZEUGSETS FÜR KLEMPNER / SET PROFESSIONALI DI IDRAULICA / JOGOS PROFISIONAL DE CANALIZAÇÃO / НАБОР САПТЕХНІКА

■ BASIC 8 PCS.



COD.	PCS.	Utilizado en / Used in / Utilisé dans		
51535	8	Sur de Europa / Southern Europe / Le Sud d'Europe	50994	8

Composición / Composition / Composition

61004, 63171, 61480, 62135, 63205, 68003, 61237, 63119

COD.	PCS.	Utilizado en / Used in / Utilisé dans		
51538	8	Centro y norte de Europa / Central and northern Europe / Centre et Nord d'Europe	50994	8

Composición / Composition / Composition



61011, 63171, 61480, 62135, 63205, 68003, 61237, 63119

COD.	PCS.	Utilizado en / Used in / Utilisé dans		
<b>51541</b>	8	América / America / L'Amérique	50994	8

Composición / Composition / Composition  
 63119, 63171, 61480, 62106, 61017, 63205, 68001, 61237

■ **ADVANCED 38 PCS.**





COD.	PCS.	Utilizado en / Used in / Utilisé dans		
<b>51536</b>	38	Sur de Europa / Southern Europe / Le Sud d'Europe	50994, 50984	15

Composición / Composition / Composition  
 55326, 63097, 61004, 63370, 61708, 61707, 65148, 65172, 63205, 68003, 63171, 61237, 69614, 63119, 66053, 66052, 66440, 66439, 66404, 66402, 66401, 62135, 61480, 61511, 61706, 61705, 61704, 61703, 61702, 61701, 62333

COD.	PCS.	Utilizado en / Used in / Utilisé dans		
<b>51539</b>	38	Centro y norte de Europa / Central and northern Europe / Centre et Nord d'Europe	50994, 50984	15

Composición / Composition / Composition  
 55326, 63097, 61011, 63370, 61708, 61707, 65148, 65172, 63205, 68003, 63171, 61237, 69614, 63119, 66053, 66052, 66440, 66439, 66404, 66402, 66401, 62135, 61480, 61511, 61706, 61705, 61704, 61703, 61702, 61701, 62333

COD.	PCS.	Utilizado en / Used in / Utilisé dans		
<b>51542</b>	38	América / America / L'Amérique	50994, 50984	15

Composición / Composition / Composition  
 55326, 63097, 65148, 63370, 61480, 61017, 65362, 63205, 68001, 63171, 61237, 69614, 63119, 66053, 66052, 66440, 66439, 55334, 55332, 55331, 62106, 61495, 60311, 60309, 60310, 60306, 60305, 60304, 60303, 60302, 62333

*BE SAFE...BE EFFICIENT*



■ MASTER 56 PCS.



COD.	PCS.	Utilizado en / Used in / Utilisé dans			
<b>51537</b>	56	Sur de Europa / Southern Europe / Le Sud d'Europe	50995, 50984	50986	21

Composición / Composition / Composition

63076, 58641, 55326, 63097, 68178, 68182, 63299, 61708, 61707, 62848, 62847, 63436, 63416, 62871, 63396, 68180, 68175, 63208, 63121, 61004, 65148, 68059, 65172, 63205, 68003, 63171, 61237, 69614, 63876, 63119, 66053, 66052, 66440, 66439, 66404, 66402, 66401, 62707, 61481, 61035, 61511, 61706, 61705, 61704, 61703, 61702, 61701, 62343, 62333

COD.	PCS.	Utilizado en / Used in / Utilisé dans			
<b>51540</b>	56	Centro y norte de Europa / Central and northern Europe / Centre et Nord d'Europe	50995, 50984	50986	21

Composición / Composition / Composition

63076, 58641, 55326, 63097, 68178, 68182, 65172, 61011, 63299, 65158, 68059, 68180, 68175, 63208, 63121, 62848, 62847, 63436, 63416, 62871, 63396, 63205, 68003, 63171, 61237, 69614, 63876, 63119, 66053, 66052, 61708, 61707, 66440, 66439, 66404, 66402, 66401, 62707, 61481, 61035, 61511, 61706, 61705, 61704, 61703, 61702, 61701, 62343, 62333

COD.	PCS.	Utilizado en / Used in / Utilisé dans			
<b>51543</b>	56	América / America / L'Amérique	50995, 50984	50986	21

Composición / Composition / Composition

63076, 58641, 55326, 63097, 68178, 68182, 63299, 61708, 61707, 62848, 62847, 63436, 63416, 62871, 63396, 68180, 68175, 63208, 63121, 61004, 65148, 68059, 65172, 63205, 68003, 63171, 61237, 69614, 63876, 63119, 66053, 66052, 66440, 66439, 66404, 66402, 66401, 62707, 61481, 61035, 61511, 61706, 61705, 61704, 61703, 61702, 61701, 62343, 62333

■ JUEGOS PROFESIONALES DE ELECTRICIDAD / PROFESSIONAL ELECTRICIAN SETS / SETS PROFESSIONNELS POUR ÉLECTRICIENS / PROFESSIONAL WERKZEUGSETS FÜR ELEKTRIKER / SET PROFESSIONALI DI ELETTICITÀ / JOGOS PROFSSIONAL DE ELETRICIDADE / НАБОР ЭЛЕКТРИКА

■ BASIC 11-12 PCS.



COD.	PCS.	Utilizado en / Used in / Utilisé dans		Medidas en / Sizes in / Mesures en	
<b>51544</b>	12	Sur de Europa / Southern Europe / Le Sud d'Europe	50983	mm	5

Composición / Composition / Composition

76603, 76552, 76654, 76652, 73042, 73035, 76595, 76583, 76657, 76656, 76653, 76651

COD.	PCS.	Utilizado en / Used in / Utilisé dans		Medidas en / Sizes in / Mesures en	
<b>51547</b>	11	América / America / L'Amérique	50983	inch	5

## Composición / Composition / Composition

76603, 76552, 73042, 73035, 76595, 76583, 76657, 76656, 75177, 75176, 75175

## ■ ADVANCED 33-34 PCS.



COD.	PCS.	Utilizado en / Used in / Utilisé dans		Medidas en / Sizes in / Mesures en	
<b>51545</b>	34	Sur de Europa / Southern Europe / Le Sud d'Europe	50994	mm	11

## Composición / Composition / Composition

76603, 55326, 73036, 73004, 76552, 76732, 76654, 76652, 73073, 73071, 73067, 73065, 73064, 73062, 73042, 76147, 73035, 79058, 65158, 65173, 69603, 63876, 65868, 73257, 76595, 76583, 76735, 76658, 76657, 76656, 76655, 76733, 76653, 76651

COD.	PCS.	Utilizado en / Used in / Utilisé dans		Medidas en / Sizes in / Mesures en	
<b>51548</b>	33	América / America / L'Amérique	50994	inch	11

## Composición / Composition / Composition

76603, 55326, 73036, 73001, 76552, 73054, 73052, 73050, 73048, 73047, 73046, 73042, 76147, 73035, 79058, 65158, 65363, 69603, 63876, 65868, 73257, 76595, 76583, 76735, 76658, 76657, 76656, 76655, 75179, 75178, 75177, 75176, 75175

## ■ MASTER 53-54 PCS.



COD.	PCS.	Utilizado en / Used in / Utilisé dans			Medidas en / Sizes in / Mesures en	
<b>51546</b>	54	Sur de Europa / Southern Europe / Le Sud d'Europe	50983, 50984	50986	mm	15

## Composición / Composition / Composition

73040, 51257, 58641, 79058, 73036, 73035, 73029, 63876, 69603, 55326, 79373, 79372, 79371, 79370, 76552, 73073, 73071, 73069, 73068, 73067, 73066, 73065, 73064, 73063, 73062, 65868, 76735, 76733, 76732, 76730, 76658, 76657, 76656, 76655, 76654, 76653, 76652, 76651, 75203, 75202, 75158, 75157, 75156, 73004, 76603, 76597, 76595, 76590, 76583, 73257, 73042, 62602, 65173, 65158



COD.	PCS.	Utilizado en / Used in / Utilisé dans			Medidas en / Sizes in / Mesures en	
51549	53	América / America / L'Amérique	50983, 50984	50986	inch	15



## Composición / Composition / Composition

69603, 76603, 76590, 58641, 55326, 73036, 73001, 76552, 65868, 79382, 79381, 79380, 79377, 73054, 73052, 73051, 73050, 73049, 73048, 73047, 73046, 73045, 73043, 73029, 73042, 73035, 73040, 79058, 65158, 65363, 51257, 63876, 75203, 75202, 79491, 79490, 79489, 62602, 73257, 76597, 76595, 76583, 76735, 76658, 76657, 76656, 76655, 75179, 75178, 75177, 75176, 75175, 75172

## ■ BANDEJAS / TRAYS / PLATEAUX / ABLAGEKASTEN / PANNELLO / TABULEIROS / ПОДДОНЫ



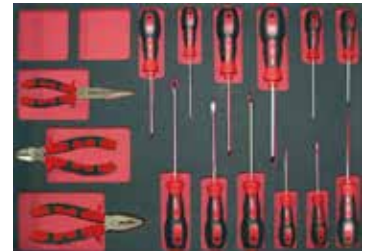

## ■ 15 PCS.

COD.	PCS.		L x W (mm)	
68954	15	51025, 51039, 50950, 51045	565 x 405	2,0
PCS.	Composición / Composition / Composition		Descripción / Description / Description	
12	66400, 66401, 66403, 66405, 66439, 66440, 66478, 66479, 66480, 66481, 66483, 66484		Destornilladores Mastertork: mecánico, Phillips®, Torx® / Screwdrivers Mastertork: slotted, Phillips®, Torx®	
3	62332, 62339, 62343		Alicates Titacrom®: universal, telefonista y corte diagonal / Pliers Titacrom®: combination, long nose, diagonal plier	





## ■ 26 PCS.

COD.	PCS.		L x W (mm)	
68955	26	51025, 51039, 50950, 51045	565 x 405	5,5
PCS.	Composición / Composition / Composition		Descripción / Description / Description	
26	61725, 61726, 61727, 61728, 61729, 61730, 61731, 61732, 61733, 61734, 61735, 61736, 61737, 61738, 61739, 61740, 61741, 61742, 61743, 61744, 61745, 61746, 61747, 61748, 61749, 61750		Llaves combinadas cromado aeroespacial / Aerospaceal chrome plating combination wrenches	



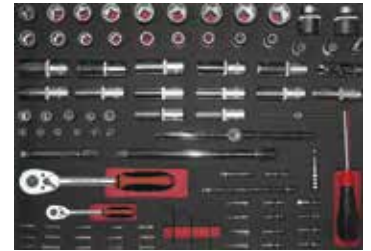

## 89 PCS.

COD.	PCS.		L x W (mm)	
<b>68956</b>	89	51025, 51039, 50950, 51045	565x 405	7,5
PCS.	Composición / Composition / Composition		Descripción / Description / Description	
46	61800, 61801, 61802, 61803, 61804, 61805, 61806, 61807, 61808, 61809, 61810, 61811, 61812, 61813, 61814, 61815, 61816, 61817, 61818, 61819, 61822, 61823, 61311, 61312, 61313, 61314, 61315, 61316, 61317, 61318, 61319, 61320, 61321, 65044, 65045, 65046, 65047, 65048, 65049, 65050, 65051, 65052, 65053, 65054, 65055, 65056		Llaves de vaso / Socket wrenches	
2	61438, 61440		Mango correrizo en T / Sliding "T" handle	
4	61442, 61444, 61455, 61458		Alargadera / Extension	
2	62603, 62606		Llave de carraca reversible / Reversible ratchet handle	
	61435, 61437		Articulación universal / Universal joint	
1	66731		Destornillador portapuntas magnético / Screwdriver magnetic bitholder	
15	58230, 58231, 58232, 58242, 58243, 58247, 58248, 58253, 58254, 58255, 58164, 58165, 58271, 58155, 58272		Puntas de destornillador Masterbit / Masterbit bits	
3	61501, 61502, 61503		Llaves hexagonales / Hexagonal keys	
1	66264		Adaptador portapuntas magnético / Magnetic bit holder	
13	66733, 66734, 66735, 66737, 66738, 66740, 66741, 66748, 66750, 66751, 66752, 66753, 66755		Puntas atornilladoras con vaso / Socket bits	





## 16 PCS.

COD.	PCS.		L x W (mm)	
<b>68957</b>	16	51025, 51039, 50950, 51045	565 x 405	4,5
PCS.	Composición / Composition / Composition		Descripción / Description / Description	
1	63742		Arco de sierra / Hack Saw	
3	62169, 62170, 62171		Tijera articulada / Aviation tin snip	
1	63876		Cortador / Cutter	
3	62848, 62850, 62851		Cinzel mecánico / Flat cold chisel	
6	63394, 63395, 63396, 63397, 63398, 63399		Botador / Pin punch	
1	69621		Martillo alemán / German type machinist's hammer	
	55326		Maceta de nylon / Nylon hammer	



## 18 PCS.

COD.	PCS.		L x W (mm)	
<b>68958</b>	18	51025, 51039, 50950, 51045	565 x 405	3,5
PCS.	Composición / Composition / Composition		Descripción / Description / Description	
11	63498, 63570, 63606, 63642, 63678, 63714, 63715, 63716, 63717, 63718, 63719		Limas / Files	
4	62180, 62181, 62182, 62183		Alicates Circlips / Circlips pliers	
	62172		Tenaza Grip / Grip plier	
1	61944		Llave ajustable / Adjustable wrench	
	62707		Tenaza de canal / Box joint	



## 7 PCS.

COD.	PCS.		L x W (mm)	
<b>68959</b>	7	51025, 51039, 50950, 51045	565 x 405	2,0
PCS.	COD.	PCS.	Descripción / Description / Description	
		69534	Tijera electricista / Electrician's scissors	
		62494	Tenaza para engastar / Crimping plier	
		62151	Tenaza cortacables / Cable cutters	
1		65167	Flexómetro / Measuring tape	
		65293	Nivel trapezoidal profesional / Professional bridge type spirit level	
		65480	Calibre / Caliper	
		66073	Buscapolos / Voltage tester	



**MOBILIARIO INDUSTRIAL MODULAR / MODULAR INDUSTRIAL FURNITURE / MOBILIER INDUSTRIEL MODULAIRE / MODULARE INDUSTRIEMÖBEL / MOBILIO INDUSTRIALE MODULARE / MOBILIÁRIO INDUSTRIAL MODULAR / МОДУЛЬНАЯ ПРОИЗВОДСТВЕННАЯ МЕБЕЛЬ**
**ARMARIO ALTO / TALL CABINET / ARMOIRE HAUTE / GROSSE WERKZEUGSCHRANK / ARMADIO ALTO / ARMÁRIO VERTICAL 2 PORTAS / ВЫСОКИЙ ШКАФ-КАБИНЕТ**
**915 × 458 × 2000**

COD.	L x W x H (mm)	Kg
<b>50111</b>	915 x 458 x 2000	78

**CARACTERÍSTICAS / FEATURES / CARACTÉRISTIQUES**

4 baldas incluidas / 4 shelves included / 4 étagères incluses

**600 × 458 × 2000**

COD.	L x W x H (mm)	Kg
<b>50112</b>	600 x 458 x 2000	55,5

**CARACTERÍSTICAS / FEATURES / CARACTÉRISTIQUES**

4 baldas incluidas / 4 shelves included / 4 étagères incluses

**BALDA / SHELF / ÉTAGÈRE / REGAL / RIPIANO / PRATELEIRA / ПОЛКА**

COD.	L x W x H (mm)	Válido para / Valid for / Valable pour
<b>50110</b>	913 x 456 X 30	50111

**ARMARIO DE PARED / WALL CABINET / ARMOIRE MURALE / WANDSCHRANK / ARMADIO DA PARETE / ARMÁRIO DE PAREDE / НАСТЕННЫЙ ШКАФ-КАБИНЕТ**
**680 × 281 × 350**

COD.	L x W x H (mm)	Kg
<b>50113</b>	680 x 281 x 350	10

**CARACTERÍSTICAS / FEATURES / CARACTÉRISTIQUES**

Puerta abatible hacia arriba / Lift up door / Porte rabattable vers le haut



COD.	L x W x H (mm)	Kg
<b>50114</b>	680 x 281 x 350	8,4

**CARACTERÍSTICAS / FEATURES / CARACTÉRISTIQUES**

Puerta corredera / Sliding door / Porte coulissante

**PANEL COLGADOR / HANGING PANEL / PANNEAU ACROCHABLE / RÜCKWANDTAFEL / PANNELLI FORATI / PAINEL PARA FERRAMENTAS / НАСТЕННАЯ ПАНЕЛЬ**

COD.	L x W x H (mm)	Kg
<b>50137</b>	1052 x 614,5 x 24	5,3
<b>50136</b>	1052 x 800 x 24	6,9

**GANCHOS OPCIONALES / OPTIONAL HOOKS / CROCHETS OPTIONNELS / OPTIONALE HAKEN / GANCI OPZIONALI / GANCHOS OPCIONAIS / ДОПОЛНИТЕЛЬНЫЕ КРЮЧКИ**

COD.	L x W x H (mm)
<b>90312</b>	60 x 35 x 58



COD.	L x W x H (mm)
90313	60 x 41 x 58

COD.	L x W x H (mm)
90315	60 x 35 x 25

COD.	L x W x H (mm)
90316	60 x 87 x 58

COD.	L x W x H (mm)
90314	370 x 34 x 48

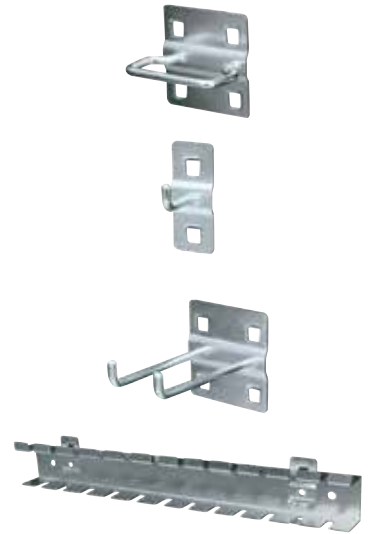

#### BALDA / SHELF / ÉTAGÈRE / REGAL / MENSOLA / PRATELEIRA / ПОЛКА

COD.	L x W x H (mm)	Kg
50138	602 x 281 x 178	3

ESPECIFICACIONES TÉCNICAS / TECHNICAL SPECIFICATION / DÉTAILS TECHNIQUES		
Máx. capacidad de carga / Max. weight capacity / Capacité maximum de charge		5 kg



#### COLUMNA / PILLAR / COLONNE / SAÛLE / COLONNA / COLUNA / РЕЙКА

32,5 X 30 X 1420

COD.	L x W x H (mm)	Kg
50117	32,5 x 30 x 1420	1,5



#### ARMARIO DOBLE PUERTA / 2 DOOR CABINET / ARMOIRE À DOUBLE PORTE / 2 TURIGE SCHRANK / ARMADIO A DUE PORTE / ARMÁRIO BAIXO COM PORTA SIMPLES / ДВУДВЕРНЫЙ КАБИНЕТ

680 x 458 x 910

COD.	L x W x H (mm)	Kg
50118	680 x 458 x 910	38

CARACTERÍSTICAS / FEATURES / CARACTÉRISTIQUES		
1 balda incluida / 1 shelf included / 1 étagère incluse		



#### BALDA / SHELF / ÉTAGÈRE / REGAL / RIPIANO / PRATELEIRA / ПОЛКА

COD.	L x W x H (mm)	Válido para / Valid for / Valable pour
50109	67x42x2,5	50118





**PAPELERA CON SUJETAPAPEL / TRASH BIN WITH PAPER HOLDER / CORBEILLE A PRESSE-PAPIER / MÜLLEIMER MIT PAPIERHALTER / MODULO FISSO DI SERVIZIO PER ARREDO OFFICINA / CAIXOTE DO LIXO COM SUPORTE DE PAPEL / МУСОРОСБОРНИК С ВСТРОЕННЫМ ДЕРЖАТЕЛЕМ РУЛОННОЙ БУМАГИ**

680 × 458 × 910

COD.	L x W x H (mm)	Kg
50119	680 x 458 x 910	54,7



**ARMARIO DE 4 CAJONES / 4 DRAWER CABINET / SERVANTES DE 4 TIROIRS / WERKZEUGWAGEN MIT 4 SCHUBLADEN / ARMADIO CON 4 CASSETTI / CARROS + 4 GAVETAS / ШКАФ-КАБИНЕТ С ЧЕТЫРЬЯ ВЪЕЗЖНЫМИ ЯЩИКАМИ**

680 × 458 × 910

COD.	L x W x H (mm)	Kg
50120	680 x 458 x 910	55,3



**ARMARIO DE 5 CAJONES / 5 DRAWER CABINET / SERVANTES DE 5 TIROIRS / WERKZEUGWAGEN MIT 5 SCHUBLADEN / ARMADIO CON 5 CASSETTI / CARROS + 5 GAVETAS / ШКАФ-КАБИНЕТ С ПЯТЬЮ ВЪЕЗЖНЫМИ ЯЩИКАМИ**

680 × 458 × 910

COD.	L x W x H (mm)	Kg
50121	680 x 458 x 910	59



680 × 458 × 731,5

COD.	L x W x H (mm)	Kg
50122	680 x 458 x 731,5	46



**CARACTERÍSTICAS / FEATURES / CARACTÉRISTIQUES**

Con ruedas / With wheels / Avec roues

**SOPORTE / SUPPORT / SUPPORT / HALTER / SUPPORTO / SUPORTE / СРЕДНЯЯ**

COD.	L x W x H (mm)	Válido para / Valid for / Valable pour	Kg
50135	450 x 330 x 32	50122	1,5



**TABLERO LAMINADO / PRESSED WOODEN BOARD / PLATEAU BOIS / HOLZ-ARBEITSPLATTE / PANNELLO LAMINATO / TAMPO EM MADEIRA / СТОЛЕШНИЦА ИЗ ПРЕССОВАННОЙ ДРЕВЕСИНЫ**

COD.	L x W x H (mm)	Kg
50123	680,5 x 463 x 36	6
50124	1361 x 463 x 36	12,5
50125	2041,5 x 463 x 36	19

**TABLERO INOXIDABLE / STAINLESS BOARD / PLATEAU INOX / EDELSTAHL BRETT / PANNELLO INOX / TAMPO EM AÇO INOXIDÁVEL / СТОЛЕШНИЦА ИЗ Н/Ж СТАЛИ**

COD.	L x W x H (mm)	Kg
50126	680,5 x 463 x 38	10,5
50127	1361 x 463 x 38	21
50128	2041,5 x 463 x 38	32

**ARMARIO DE PARED EN ESQUINA / CORNER WALL CABINET / ARMOIRE MURALE D'ANGLE / ECKWAND KABINETT / ARMADIO DA PARETE AD ANGOLO / ARMÁRIO DE ESQUINA / УГЛОВОЙ НАСТЕННЫЙ КАБИНЕТ**

865 × 865 × 350

COD.	L x W x H (mm)	Kg
50130	865 x 865 x 350	21

**MADERA LAMINADA EN ESQUINA / CORNER PRESSED WOOD / PLATEAU D'ANGLE BOIS / ECKIGE GEPRESSTEM HOLZBRETT / COPERCHIO IN LEGNO LAMINATO AD ANGOLO / TABULEIRO ANGULAR EM MADEIRA / УГЛОВАЯ СТОЛЕШНИЦА ИЗ ПРЕССОВАННОЙ ДРЕВЕСИНЫ**

865 × 865 × 36

COD.	L x W x H (mm)	Kg
50131	865 x 865 x 36	13

**TAPA INOXIDABLE EN ESQUINA / CORNER STAINLESS TOP / COUVERCLE INOX, D'ÀNGLE / ECKIGE EDELSTAHL BRETT / COPERCHIO IN INOX AD ANGOLO / TABULEIRO ANGULAR EM AÇO INOXIDÁVEL / УГЛОВАЯ СТОЛЕШНИЦА ИЗ Н/Ж СТАЛИ**

865 × 865 × 38,6

COD.	L x W x H (mm)	Kg
50133	865 x 865 x 38,6	18

**ARMARIO BAJO EN ESQUINA / CORNER BASE CABINET / MEUBLE D'ANGLE BAS / ECKUNTERSCHRANK / ARMADIO BASSO AD ANGOLO / ARMÁRIO BAIXO DE ESQUINA / УГЛОВОЙ СТОЛ-КАБИНЕТ**

865 × 865 × 910

COD.	L x W x H (mm)	Kg
50134	865 x 865 x 910	41,5



### COMBINATION 1

#### 2275 x 2000

COD.	L x H (mm)	
<b>50101</b>	2275 x 2000	
PCS.	COD. PCS.	
1	50111	
	50113	
	50114	
2	50137	
5	50117	
	50124	
1	50121	
	50118	

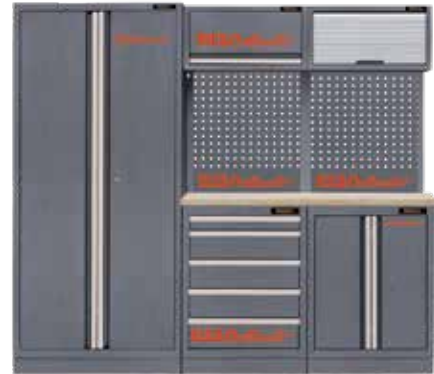

### COMBINATION 2

#### 2640 x 2000

COD.	L x H (mm)	
<b>50102</b>	2640 x 2000	
PCS.	COD. PCS.	
1	50112	
2	50113	
1	50114	
3	50137	
7	50117	
	50125	
	50121	
1	50122	
	50118	



### COMBINATION 3

#### 2955 x 2000

COD.	L x H (mm)	
<b>50103</b>	2955 x 2000	
PCS.	COD. PCS.	
1	50111	
2	50113	
1	50114	
3	50137	
7	50117	
	50125	
	50121	
1	50119	
	50118	



#### COMBINATION 4

4235 x 2000

COD.	L x H (mm)	
<b>50104</b>	4235 x 2000	
PCS.	COD. PCS.	
1	50111	
	50112	
2	50113	
	50114	
4	50137	
10	50117	
2	50127	
	50121	
	50119	
1	50118	
	50120	

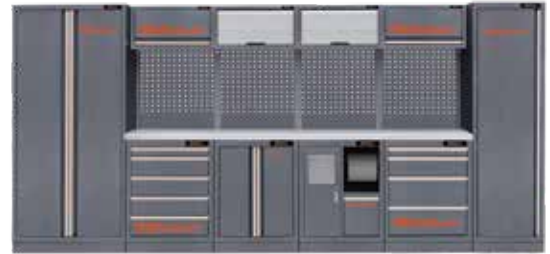

#### COMBINATION 5

4915 x 2000

COD.	L x H (mm)	
<b>50105</b>	4915 x 2000	
PCS.	COD. PCS.	
	50111	
	50112	
	50121	
1	50118	
	50120	
	50122	
	50119	
2	50114	
3	50113	
5	50137	
12	50117	
	50128	
1	50127	



#### COMBINACIÓN DE ALMACENAJE EN ESQUINA / CORNER STORAGE COMBINATION / COMBINAISON DE STOCKAGE D'ANGLE / ECKIGE LAGERUNGSKOMBINATION / COMBINAZIONE STOCCAGGIO AD ANGOLO / COMBINAÇÃO DE ARMAZÉM DE ESQUINA / УГЛОВОЙ КОМПЛЕКТ МЕБЕЛИ

865 x 2000

COD.	L x H (mm)	
<b>50106</b>	865 x 2000	
PCS.	COD. PCS.	
1	50130	
6	50117	
1	50131	
2	50136	
1	50134	



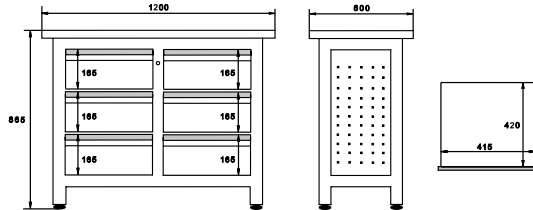

**■ MESAS DE TRABAJO / WORK BENCHES / TABLES DE MONTEUR / ARBEITSTISCHE / TAVOLI DI LAVORO / BANCADAS DE TRABALHO / РАБОЧИЕ ВЕРСТАКИ**
**■ 1200 X 600 X 865**

COD.	L x W x H (mm)	Kg
<b>51557</b>	1200 x 600 x 865	79

**ESPECIFICACIONES TÉCNICAS / TECHNICAL SPECIFICATION / DÉTAILS TECHNIQUES**

Cajones con rodamientos / <i>Ball-bearing slides</i> / <i>Tiroirs à roulement</i>	6
Sistema de cierre centralizado / <i>Central locking system</i> / <i>Système de fermeture centralisée</i>	●
Capacidad de carga estática total / <i>Total static weight capacity</i> / <i>Capacité totale de charge statique</i>	300 Kg

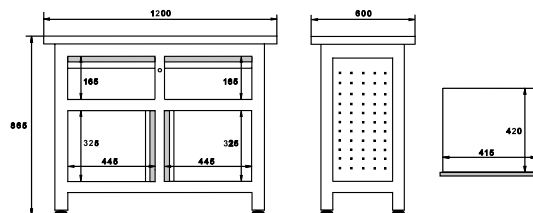

COD.	L x W x H (mm)	Kg
<b>51556</b>	1200 x 600 x 865	68

**ESPECIFICACIONES TÉCNICAS / TECHNICAL SPECIFICATION / DÉTAILS TECHNIQUES**

Puertas / <i>Doors</i> / <i>Portes</i>	2
Cajones con rodamientos / <i>Ball-bearing slides</i> / <i>Tiroirs à roulement</i>	2
Sistema de cierre centralizado / <i>Central locking system</i> / <i>Système de fermeture centralisée</i>	●
Capacidad de carga estática total / <i>Total static weight capacity</i> / <i>Capacité totale de charge statique</i>	300 Kg

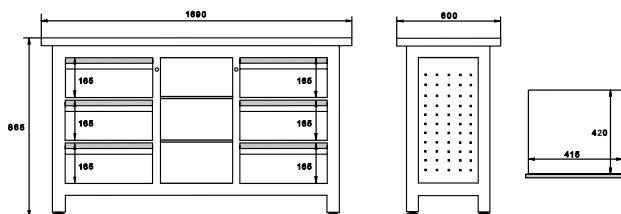

**■ 1690 X 600 X 865**

COD.	L x W x H (mm)	Kg
<b>51578</b>	1690 x 600 x 865	99

**ESPECIFICACIONES TÉCNICAS / TECHNICAL SPECIFICATION / DÉTAILS TECHNIQUES**

Baldas / <i>Shelves</i> / <i>Étagères</i>	3
Cajones con rodamientos / <i>Ball-bearing slides</i> / <i>Tiroirs à roulement</i>	6
Sistema de cierre centralizado / <i>Central locking system</i> / <i>Système de fermeture centralisée</i>	●
Capacidad de carga estática total / <i>Total static weight capacity</i> / <i>Capacité totale de charge statique</i>	300 Kg

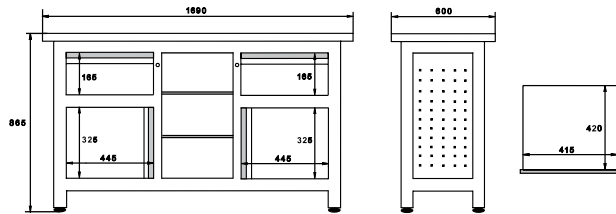



COD.	L x W x H (mm)	Kg
51577	1690 x 600 x 865	87



ESPECIFICACIONES TÉCNICAS / TECHNICAL SPECIFICATION / DÉTAILS TECHNIQUES	
Baldas / Shelves / Étagères	3
Puertas / Doors / Portes	2
Cajones con rodamientos / Ball-bearing slides / Tiroirs à roulement	2
Sistema de cierre centralizado / Central locking system / Système de fermeture centralisée	●
Capacidad de carga estática total / Total static weight capacity / Capacité totale de charge statique	300 Kg

### ARMARIOS DE PARED / WALL CABINETS / ARMOIRES MURALES / WANDWERKZEUGSCHRANK / ARMADI DA PARETE / ARMÁRIO DE PAREDE / ШКАФ ИНСТРУМЕНТАЛЬНЫЙ НАСТЕННЫЙ

1200 x 200 x 600

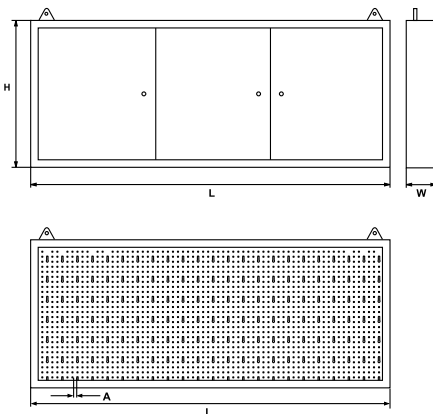

COD.	L x W x H (mm)	A (mm)	Kg
51475	1200 x 200 x 600	10	17,5

ESPECIFICACIONES TÉCNICAS / TECHNICAL SPECIFICATION / DÉTAILS TECHNIQUES	
Baldas / Shelves / Étagères	3
Puertas / Doors / Portes	3
Ganchos incluidos / Hook included / Crochets inclus	6 cortos: cod. 90172 - 12 largos: cod. 90173 / 6 shorts: cod. 90172 - 12 longs: cod. 90173 / 6 courts: cod. 90172 - 12 longs: cod. 90173
Cerradura con llave / Key lock / Serrure avec clé	●



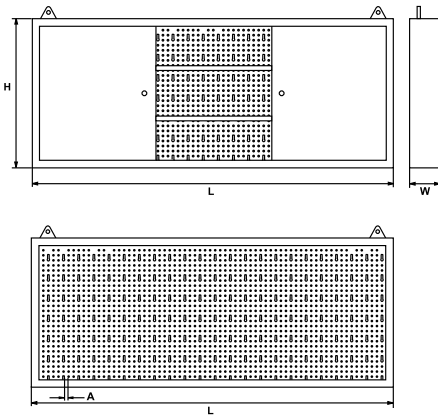

COD.	L x W x H (mm)	A (mm)	Kg
<b>51476</b>	1200 x 200 x 600	10	15,6

### ESPECIFICACIONES TÉCNICAS / TECHNICAL SPECIFICATION / DÉTAILS TECHNIQUES

Baldas / Shelves / Étagères	3
Puertas / Doors / Portes	2
Ganchos incluidos / Hook included / Crochets inclus	6 cortos: cod. 90172 - 12 largos: cod. 90173 / 6 shorts: cod. 90172 - 12 longs: cod. 90173 / 6 courts: cod. 90172 - 12 longs: cod. 90173
Cerradura con llave / Key lock / Serrure avec clé	●

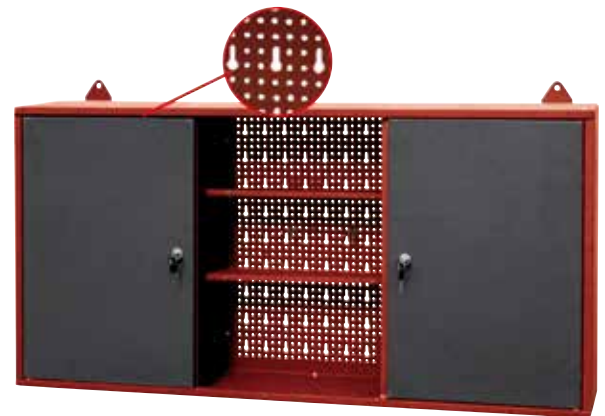

### REPUESTOS / SPARE PARTS / RECHANGES / ERSATZTEILE / ACCESSORI / ACESSORIOS / ЗАПАСНЫЕ ЧАСТИ

COD.	Descripción / Description / Description	Cortos / Shorts / Courts	Largos / Longs / Longs
<b>90172</b>	Ganchos / Hooks / Crochets	—	—
<b>90173</b>		—	—



### 680 x 300 x 680

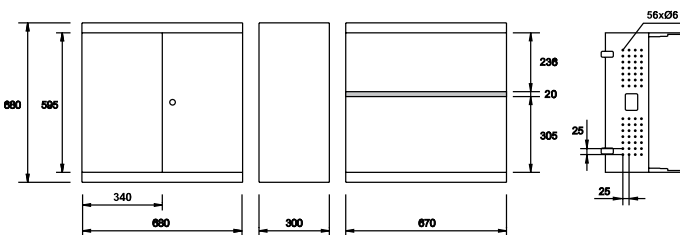

COD.	L x W x H (mm)	Kg
<b>50976</b>	680 x 300 x 680	17

### ESPECIFICACIONES TÉCNICAS / TECHNICAL SPECIFICATION / DÉTAILS TECHNIQUES

Baldas / Shelves / Étagères	1
Cerradura con llave / Key lock / Serrure avec clé	●

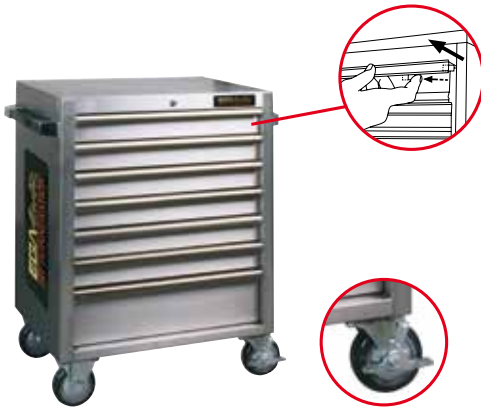

**ARMARIOS-CARROS DE HERRAMIENTAS 100% INOX / ROLLER CABINETS 100% INOX / SERVANTES À ROUES 100% INOX / WERKZEUGWAGEN 100% INOX / CASSETTIERE MOBILI 100% INOX / CARRO DE FERRAMENTAS 100% INOX / ШКАФЫ-ТЕЛЕЖКИ ДЛЯ ИНСТРУМЕНТОВ 100% НЕРЖАВЕЮЩАЯ СТАЛЬ**
**680 × 470 × 935**

Sistema antivuelco con botón de seguridad de apertura individual por bandeja  
 Anti-overturn system with individual safety open button in each tray  
 Système anti-renversement avec bouton de sécurité d'ouverture individuelle par tiroir

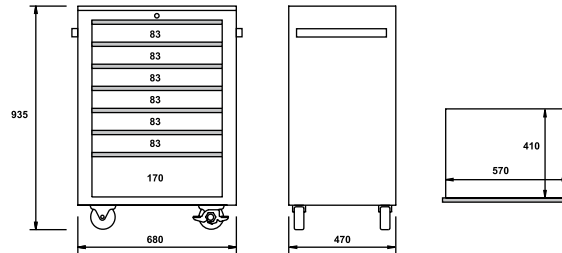

COD.	L x W x H (mm)	Material estructura / Material structure / Structure matériaux	Kg
51558	680 x 470 x 935	Inox 304	63

**INOX**
**ESPECIFICACIONES TÉCNICAS / TECHNICAL SPECIFICATION / DÉTAILS TECHNIQUES**

Material / Material / Matière	Exterior e interior 100% INOX / Exterior and interior 100% INOX / Extérieur et intérieur 100% INOX
Cajones con rodamientos / Ball-bearing slides / Tiroirs à roulement	7
2 ruedas fijas y 2 giratorias con freno / 2 fixed and 2 revolving with brake wheels / 2 roues fixes et 2 roues giratoires avec frein	5" x 1,5"
Capacidad cajones de altura 83 mm / Capacity in 83 mm height drawers / Capacité des tiroirs de 83 mm de haut	25 Kg
Capacidad cajones de altura 170 mm / Capacity in 170 mm height drawers / Capacité des tiroirs de 170 mm de haut	30 Kg
Capacidad de carga estática total / Total static weight capacity / Capacité totale de charge statique	320 Kg
Sistema de cierre centralizado / Central locking system / Système de fermeture centralisée	•
Asa lateral reforzada / Reinforced side handle / Poignées latérale renforcée	•
Sistema antivuelco en cada bandeja / Anti-overturn system in each drawers / Système anti-renversement dans chaque tiroir	•



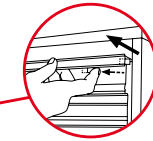

Sistema antivuelco con botón de seguridad de apertura individual por bandeja  
Anti-ovrtum system with individual safety open button in each tray  
Système anti-renversement avec bouton de sécurité d'ouverture individuelle par tiroir

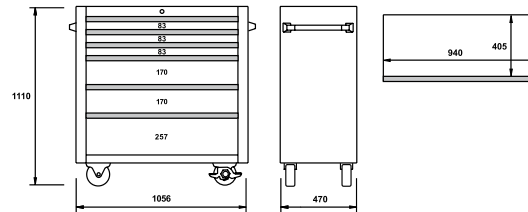

COD.	L x W x H (mm)	Material estructura / Material structure / Structure matériaux	Kg
51559	1056 x 470 x 1110	Inox 304	95

INOX

**ESPECIFICACIONES TÉCNICAS / TECHNICAL SPECIFICATION / DÉTAILS TECHNIQUES**

Material / Material / Matière	Exterior e interior 100% INOX / Exterior and interior 100% INOX / Extérieur et intérieur 100% INOX
Cajones con rodamientos / Ball-bearing slides / Tiroirs à roulement	6
2 ruedas fijas y 2 giratorias con freno / 2 fixed and 2 revolving with brake wheels / 2 roues fixes et 2 roues giratoires avec frein	5" x 1,5"
Capacidad cajones de altura 83 mm / Capacity in 83 mm height drawers / Capacité des tiroirs de 83 mm de haut	25 Kg
Capacidad cajones de altura 170 mm / Capacity in 170 mm height drawers / Capacité des tiroirs de 170 mm de haut	30 Kg
Capacidad cajones de altura 257 mm / Capacity in 257 mm height drawers / Capacité des tiroirs de 257 mm de haut	30 kg
Capacidad de carga estática total / Total static weight capacity / Capacité totale de charge statique	500 kg
Sistema de cierre centralizado / Central locking system / Système de fermeture centralisée	●
Asa lateral reforzada / Reinforced side handle / Poignées latérale renforcée	●
Sistema antivuelco en cada bandeja / Anti-ovrtum system in each drawers / Système anti-renversement dans chaque tiroir	●

# BE SAFE...BE EFFICIENT

**ARMARIOS-CARROS DE HERRAMIENTAS DE SUPERFICIES INOX\* / INOX SURFACE ROLLER CABINETS\* / SERVANTES À ROUES AVEC SURFACE INOX\* / WERKZEUGWAGEN MIT INOX OBERFLÄCHE\* / CASSETTIERE MOBILI PORTAUTENSILI DI SUPERFICI INOX\* / ARMÁRIOS-CARROS DE FERRAMENTA DE SUPERFÍCIE INOX\* / ШКАФЫ-ТЕЛЕЖКИ ДЛЯ ИНСТРУМЕНТОВ С ПОКРЫТИЕМ ИЗ НЕРЖАВЕЮЩЕЙ СТАЛИ\***

680 × 470 × 935

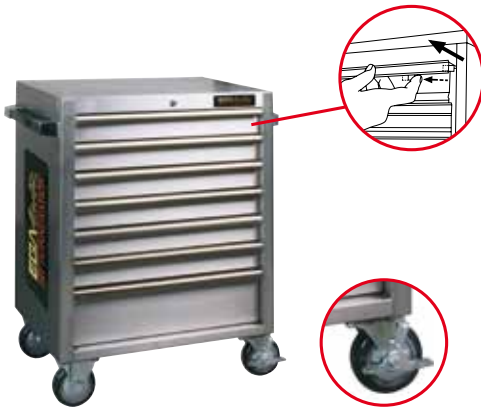

Sistema antivuelco con botón de seguridad de apertura individual por bandeja  
 Anti-overtum system with individual safety open button in each tray  
 Système anti-renversement avec bouton de sécurité d'ouverture individuelle par tiroir

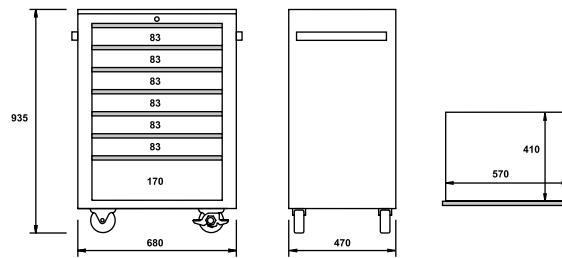

COD.	L x W x H (mm)	Material estructura / Material structure / Structure matériaux	Material ruedas / Wheel material / Matière roues	
51478	680 x 470 x 935	Inox 430	Inox 304	63

INOX

**ESPECIFICACIONES TÉCNICAS / TECHNICAL SPECIFICATION / DÉTAILS TECHNIQUES**

Material* / Material* / Matière*	Exterior 100% INOX - Interior: Acero pintado - Placa fijación ruedas: Acero / Exterior 100% INOX - Interior: Painted Steel - Wheel fixing plate: Steel / Extérieur 100% INOX - Intérieur: Acier peint - Roues de fixation: Acier
Cajones con rodamientos / Ball-bearing slides / Tiroirs à roulement	7
2 ruedas fijas y 2 giratorias con freno / 2 fixed and 2 revolving with brake wheels / 2 roues fixes et 2 roues giratoires avec frein	5" x 1,5"
Capacidad cajones de altura 83 mm / Capacity in 83 mm height drawers / Capacité des tiroirs de 83 mm de haut	25 Kg
Capacidad cajones de altura 170 mm / Capacity in 170 mm height drawers / Capacité des tiroirs de 170 mm de haut	30 Kg
Capacidad de carga estática total / Total static weight capacity / Capacité totale de charge statique	320 Kg
Sistema de cierre centralizado / Central locking system / Système de fermeture centralisée	●
Asa lateral reforzada / Reinforced side handle / Poignées latérale renforcée	●
Sistema antivuelco en cada bandeja / Anti-overtum system in each drawers / Système anti-renversement dans chaque tiroir	●

680 × 470 × 1420

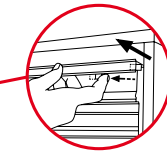

Sistema antivuelco con botón de seguridad de apertura individual por bandeja  
 Anti-overturn system with individual safety open button in each tray  
 Système anti-renversement avec bouton de sécurité d'ouverture individuelle par tiroir

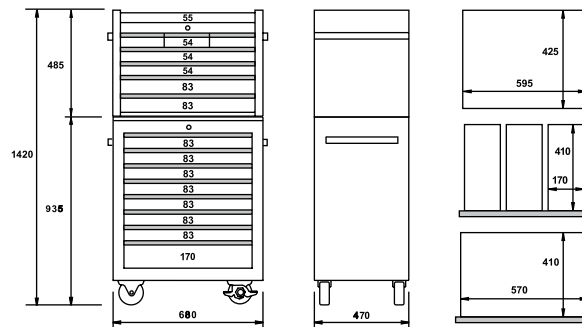

COD.	L x W x H (mm)	Kg	Material estructura / Material structure / Structure matériaux	Material ruedas / Wheel material / Matière roues
51563	680 x 470 x 1420	109	Inox 430	Inox 304

INOX

**ESPECIFICACIONES TÉCNICAS / TECHNICAL SPECIFICATION / DÉTAILS TECHNIQUES**

Material* / Material* / Matière*	Exterior 100% INOX - Interior: Acero pintado - Placa fijación ruedas: Acero / Exterior 100% INOX - Interior: Painted Steel - Wheel fixing plate: Steel / Extérieur 100% INOX - Intérieur: Acier peint - Roues de fixation: Acier
Cajones con rodamientos / Ball-bearing slides / Tiroirs à roulement	14
2 ruedas fijas y 2 giratorias con freno / 2 fixed and 2 revolving with brake wheels / 2 roues fixes et 2 roues giratoires avec frein	5" x 1,5"
Capacidad cajones 170 x 410 x 54 mm / Drawer capacity 170 x 410 x 54 mm / Capacité des tiroirs de 170 x 410 x 54 mm	15 kg
Capacidad cajones 570 x 410 x 54 mm / Drawer capacity 570 x 410 x 54 mm / Capacité des tiroirs de 570 x 410 x 54 mm	25 kg
Capacidad cajones de altura 83 mm / Capacity in 83 mm height drawers / Capacité des tiroirs de 83 mm de haut	25 kg
Capacidad cajones de altura 170 mm / Capacity in 170 mm height drawers / Capacité des tiroirs de 170 mm de haut	30 kg
Capacidad de carga estática total / Total static weight capacity / Capacité totale de charge statique	470 kg
Sistema de cierre centralizado / Central locking system / Système de fermeture centralisée	●
Asa lateral reforzada / Reinforced side handle / Poignées latérale renforcée	●
Sistema antivuelco en cada bandeja / Anti-overturn system in each drawers / Système anti-renversement dans chaque tiroir	●
Tapa con doble pistón neumático / Double pneumatic absorber equipped lid / Couvercle avec double piston pneumatique	●

## ■ 1056 × 470 × 1110

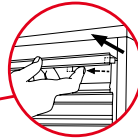

Sistema antivuelco con botón de seguridad de apertura individual por bandeja  
*Anti-overturn system with individual safety open button in each tray*  
 Système anti-renversement avec bouton de sécurité d'ouverture individuelle par tiroir

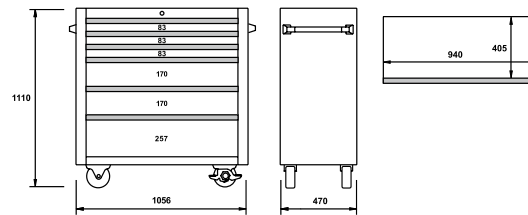

COD.	L x W x H (mm)	Material estructura / Material structure / Structure matériaux	Material ruedas / Wheel material / Matière roues	
51561	1056 x 470 x 1110	Inox 430	Inox 304	95

INOX

## ESPECIFICACIONES TÉCNICAS / TECHNICAL SPECIFICATION / DÉTAILS TECHNIQUES

Material* / Material* / Matière*	Exterior 100% INOX - Interior: Acero pintado - Placa fijación ruedas: Acero / Exterior 100% INOX - Interior: Painted Steel - Wheel fixing plate: Steel / Extérieur 100% INOX - Intérieur: Acier peint - Roues de fixation: Acier
Cajones con rodamientos / Ball-bearing slides / Tiroirs à roulement	6
2 ruedas fijas y 2 giratorias con freno / 2 fixed and 2 revolving with brake wheels / 2 roues fixes et 2 roues giratoires avec frein	5" x 1,5"
Capacidad cajones de altura 83 mm / Capacity in 83 mm height drawers / Capacité des tiroirs de 83 mm de haut	25 Kg
Capacidad cajones de altura 170 mm / Capacity in 170 mm height drawers / Capacité des tiroirs de 170 mm de haut	30 Kg
Capacidad cajones de altura 257 mm / Capacity in 257 mm height drawers / Capacité des tiroirs de 257 mm de haut	30 kg
Capacidad de carga estática total / Total static weight capacity / Capacité totale de charge statique	500 kg
Sistema de cierre centralizado / Central locking system / Système de fermeture centralisée	●
Asa lateral reforzada / Reinforced side handle / Poignées latérale renforcée	●
Sistema antivuelco en cada bandeja / Anti-overturn system in each drawers / Système anti-renversement dans chaque tiroir	●



■ 1056 × 470 × 1686

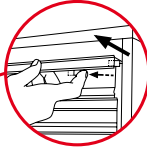

Sistema antivuelco con botón de seguridad de apertura individual por bandeja  
 Anti-overtum system with individual safety open button in each tray  
 Système anti-renversement avec bouton de sécurité d'ouverture individuelle par tiroir

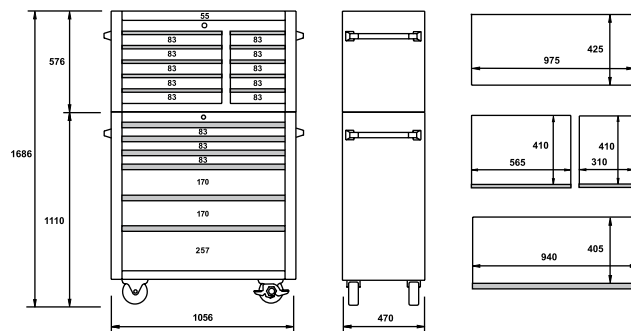





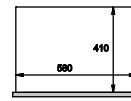
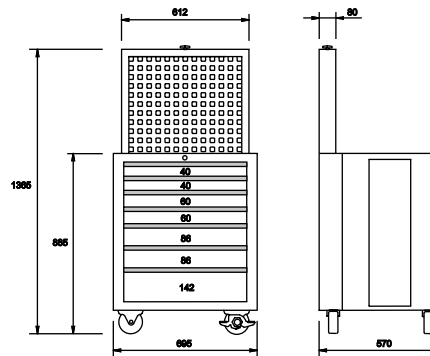

COD.	L x W x H (mm)	Kg	Material estructura / Material structure / Structure matériaux	Material ruedas / Wheel material / Matière roues
51564	1056 x 470 x 1686	168	Inox 430	Inox 304

INOX

**ESPECIFICACIONES TÉCNICAS / TECHNICAL SPECIFICATION / DÉTAILS TECHNIQUES**

Material* / Material* / Matière*	Exterior 100% INOX - Interior: Acero pintado - Placa fijación ruedas: Acero / Exterior 100% INOX - Interior: Painted Steel - Wheel fixing plate: Steel / Extérieur 100% INOX - Intérieur: Acier peint - Roues de fixation: Acier
Cajones con rodamientos / Ball-bearing slides / Tiroirs à roulement	16
2 ruedas fijas y 2 giratorias con freno / 2 fixed and 2 revolving with brake wheels / 2 roues fixes et 2 roues giratoires avec frein	5" x 1,5"
Capacidad cajones de altura 55 mm / Capacity in 55 mm height drawers / Capacité des tiroirs de 55 mm de haut	30 kg
Capacidad cajón 310 x 410 x 83 mm / Drawer capacity 310 x 410 x 83 mm / Capacité du tiroir 310 x 410 x 83 mm	25 kg
Capacidad cajón 565 x 410 x 83 mm / Drawer capacity 565 x 410 x 83 mm / Capacité du tiroir 565 x 410 x 83 mm	25 kg
Capacidad cajones de altura 83 mm / Capacity in 83 mm height drawers / Capacité des tiroirs de 83 mm de haut	25 Kg
Capacidad cajones de altura 170 mm / Capacity in 170 mm height drawers / Capacité des tiroirs de 170 mm de haut	30 Kg
Capacidad cajones de altura 257 mm / Capacity in 257 mm height drawers / Capacité des tiroirs de 257 mm de haut	30 kg
Capacidad de carga estática total / Total static weight capacity / Capacité totale de charge statique	700 kg
Sistema de cierre centralizado / Central locking system / Système de fermeture centralisée	●
Asa lateral reforzada / Reinforced side handle / Poignées latérale renforcée	●
Sistema antivuelco en cada bandeja / Anti-overtum system in each drawers / Système anti-renversement dans chaque tiroir	●





**ARMARIOS-CARROS DE HERRAMIENTAS / ROLLER CABINETS / SERVANTES À ROUES / WERKSTATTWAGEN / CASSETTIERE MOBILI / CARRO DE FERRAMENTAS COM GAVETAS / ТЕЛЕЖКИ НА РОЛИКАХ**
**695 x 570 x 1365**

COD.	L x W x H (mm)		Color / Colour / Couleur
51045	695 x 570 x 1365	60	
51305			
51306			
51307			

**ESPECIFICACIONES TÉCNICAS / TECHNICAL SPECIFICATION / DÉTAILS TECHNIQUES**

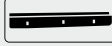

7 cajones con rodamientos / 7 ball-bearing slides / 7 tiroirs à roulement	●
Número de agujeros del panel / Number of holes of the panel / Nombre de trous du panneau	12 x 12
Estructura reforzada / Reinforced heavy duty structure / Structure renforcée	●
Sistema de cierre centralizado en el panel y en el carro / Central locking system in the panel and in the cabinet / Système de fermeture centralisée dans le panneau et la servante	●
Capacidad de carga estática total / Total static weight capacity / Capacité totale de charge statique	500 kg
Capacidad cajones de altura 142 mm / Capacity in 142 mm height drawers / Capacité des tiroirs de 142 mm de haut	50 kg
Capacidad cajones de altura 86 mm / Capacity in 86 mm height drawers / Capacité des tiroirs de 86 mm de haut	40 kg
Capacidad cajones de altura 60 mm / Capacity in 60 mm height drawers / Capacité des tiroirs de 60 mm de haut	30 kg
Capacidad cajones de altura 40 mm / Capacity in 40 mm height drawers / Capacité des tiroirs de 40 mm de haut	30 kg
2 ruedas fijas y 2 giratorias con freno / 2 fixed and 2 revolving with brake wheels / 2 roues fixes et 2 roues giratoires avec frein	5" x 2"
Panel accionado neumáticamente / Pneumatically operated panel / Panneau actionné pneumatiquement	●

**CAJAS DE PLÁSTICO / PLASTIC BINS / CAISSES EN PLASTIQUE / KUNSTOFF BEHÄLTER / CASSETTE DI PLASTICA / CAIXA DE PLÁSTICO / ПЛАСТИКОВЫЕ ЯЩИКИ**





COD.	L x W x H (mm)			Color / Colour / Couleur
90185	140 x 105 x 75	90184	80	
90186	220 x 140 x 125		180	
90187	270 x 140 x 125		260	

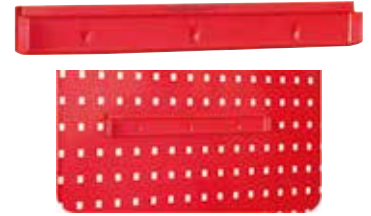
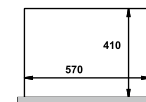
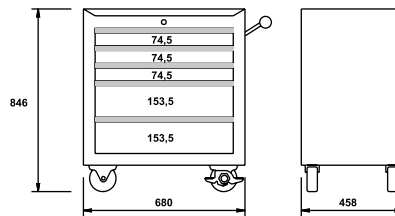

**SOPORTE PARA CAJAS DE PLÁSTICO / BIN HOLDER FOR PLASTIC BINS / SUPPORT POUR CAISSE EN PLASTIQUE / HALTER FÜR KUNSTOFF BEHÄLTER / SUPPORTO PER CASSETTE DI PLASTICA / SUPORTE PARA CAIXAS PLÁSTICAS / ПОДСТАВКА ДЛЯ ПЛАСТИКОВЫХ ЯЩИКОВ**

COD.		L x W x H (mm)	
90184	260	440 x 39 x 19,5	90185 90186 90187



**680 x 458 x 846**

COD.	L x W x H (mm)		Color / Colour / Couleur
51674	680 x 458 x 846	43	
51675			
51676			
51677			

**ESPECIFICACIONES TÉCNICAS / TECHNICAL SPECIFICATION / DÉTAILS TECHNIQUES**

5 cajones con rodamientos / 5 ball-bearing slides / 5 tiroirs à roulement	●
2 ruedas fijas y 2 giratorias con freno / 2 fixed and 2 revolving with brake wheels / 2 roues fixes et 2 roues giratoires avec frein	5" x 2"
Capacidad cajones de altura 74,5 mm / Capacity in 74,5 mm height drawers / Capacité des tiroirs de 74,5 mm de haut	20 kg
Capacidad cajones de altura 153,5 mm / Capacity in 153,5 mm height drawers / Capacité des tiroirs de 153,5 mm de haut	25 kg
Capacidad de carga estática total / Total static weight capacity / Capacité totale de charge statique	300 kg
Sistema de cierre centralizado / Central locking system / Système de fermeture centralisée	●
Estructura reforzada / Reinforced heavy duty structure / Structure renforcée	●

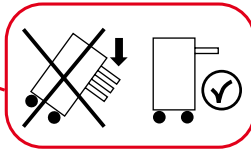
■ 695 × 470 × 885



Sistema OODO Antivuelco  
 OODO Antioverturn System  
 (Only One Drawer Open)  
 Système OODO Anti-renversement



Disponible en 4 colores  
 Available in 4 colors  
 Disponible en 4 couleurs

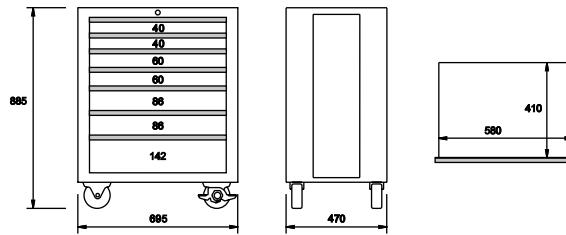

COD.	L x W x H (mm)	Kg	Color / Colour / Couleur
51025	695 x 470 x 885	50	
51484			
51496			
51508			

### ESPECIFICACIONES TÉCNICAS / TECHNICAL SPECIFICATION / DÉTAILS TECHNIQUES

7 cajones con rodamientos / 7 ball-bearing slides / 7 tiroirs à roulement	●
2 ruedas fijas y 2 giratorias con freno / 2 fixed and 2 revolving with brake wheels / 2 roues fixes et 2 roues giratoires avec frein	5" x 2"
Capacidad cajones de altura 40 mm / Capacity in 40 mm height drawers / Capacité des tiroirs de 40 mm de haut	30 kg
Capacidad cajones de altura 60 mm / Capacity in 60 mm height drawers / Capacité des tiroirs de 60 mm de haut	30 kg
Capacidad cajones de altura 86 mm / Capacity in 86 mm height drawers / Capacité des tiroirs de 86 mm de haut	40 kg
Capacidad cajones de altura 142 mm / Capacity in 142 mm height drawers / Capacité des tiroirs de 142 mm de haut	50 kg
Capacidad de carga estática total / Total static weight capacity / Capacité totale de charge statique	500 kg
Sistema de cierre centralizado / Central locking system / Système de fermeture centralisée	●
Estructura reforzada / Reinforced heavy duty structure / Structure renforcée	●

# EGA Master

## ART IN INNOVATION





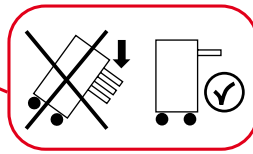

■ 730 × 475 × 1030

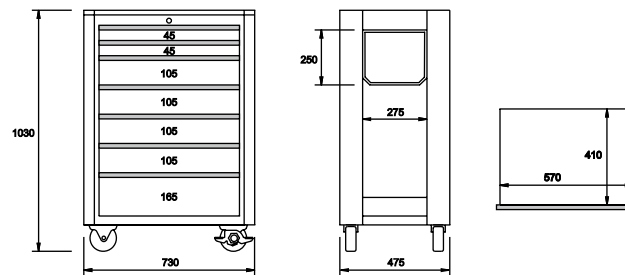

Sistema OODO Antivuelco  
OODO Antioverturn System  
(Only One Drawer Open)  
Système OODO Anti-renversement



Disponible en 4 colores  
Available in 4 colors  
Disponible en 4 couleurs

COD.	L x W x H (mm)	Kg	Color / Colour / Couleur
51039	730 x 475 x 1030	50	
51486			
51498			
51510			

#### ESPECIFICACIONES TÉCNICAS / TECHNICAL SPECIFICATION / DÉTAILS TECHNIQUES

7 cajones con rodamientos / 7 ball-bearing slides / 7 tiroirs à roulement	●
Bandeja lateral plegable / Lateral foldable tray / Plateau lateral pliable	●
Estructura reforzada / Reinforced heavy duty structure / Structure renforcée	●
Sistema antivuelco en cada bandeja / Anti-overturn system in each drawers / Système anti-renversement dans chaque tiroir	●
Sistema de cierre centralizado / Central locking system / Système de fermeture centralisée	●
Capacidad de carga estática total / Total static weight capacity / Capacité totale de charge statique	500 kg
Capacidad cajones de altura 165 mm / Capacity in 165 mm height drawers / Capacité des tiroirs de 165 mm de haut	50 kg
Capacidad cajones de altura 105 mm / Capacity in 105 mm height drawers / Capacité des tiroirs de 105 mm de haut	40 kg
Capacidad cajones de altura 45 mm / Capacity in 45 mm height drawers / Capacité des tiroirs de 45 mm de haut	30 kg
2 ruedas fijas y 2 giratorias con freno / 2 fixed and 2 revolving with brake wheels / 2 roues fixes et 2 roues giratoires avec frein	5" x 2"
Colgador lateral para herramientas / Lateral tool holder / Rangement latéral d'outils	●

■ 730 × 475 × 1500

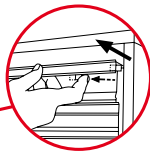

Sistema antivuelco con botón de seguridad de apertura individual por bandeja  
 Anti-overflow system with individual safety open button in each tray  
 Système anti-renversement avec bouton de sécurité d'ouverture individuelle par tiroir

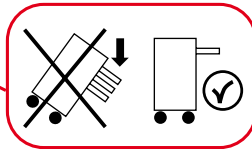

Sistema OODO Antivuelco  
 OODO Antioverturn System  
 (Only One Drawer Open)  
 Système OODO Anti-renversement



Disponible en 4 colores  
 Available in 4 colors  
 Disponible en 4 couleurs

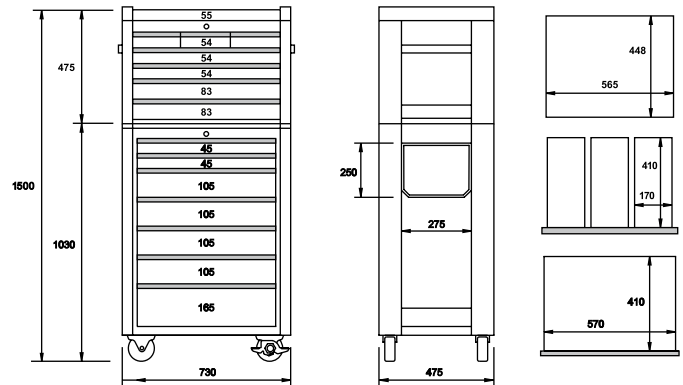

COD.	L x W x H (mm)				Color / Colour / Couleur
51117	730 x 475 x 1500	51039	51075	97	
51516		51486	51490		
51519		51498	51502		
51522		51510	51514		

### ESPECIFICACIONES TÉCNICAS / TECHNICAL SPECIFICATION / DÉTAILS TECHNIQUES

Cajones con rodamientos / Ball-bearing slides / Tiroirs à roulement	●
Bandeja lateral plegable / Lateral foldable tray / Plateau lateral pliable	●
Estructura reforzada / Reinforced heavy duty structure / Structure renforcée	●
Sistema antivuelco en cada bandeja / Anti-overflow system in each drawers / Système anti-renversement dans chaque tiroir	●
Sistema de cierre centralizado / Central locking system / Système de fermeture centralisée	●
Cofre con asas laterales / Chest with side handles / Coffre avec poignées latérales	●
Cofre: Capacidad de carga estática total / Chest: Total static weight capacity / Coffre: Capacité totale de charge statique	140 kg
Cofre: Capacidad cajones de 570 x 410 x 54 mm / Chest: Capacity in 570 x 410 x 54 mm drawers / Coffre: Capacité des tiroirs de 570 x 410 x 54 mm	20 kg
Cofre: Capacidad cajones de 170 x 410 x 54 mm / Chest: Capacity in 170 x 410 x 54 mm drawers / Coffre: Capacité des tiroirs de 170 x 410 x 54 mm	15 kg
Cofre: Capacidad cajón de altura 83 mm / Chest: Capacity in 83 mm height drawer / Coffre: Capacité du tiroir de 83 mm de haut	25 kg
Cofre: Capacidad cajón de altura 55 mm / Chest: Capacity in 55 mm height drawer / Coffre: Capacité du tiroir de 55 mm de haut	20 kg
Capacidad de carga estática total / Total static weight capacity / Capacité totale de charge statique	640 kg
Capacidad cajones de altura 165 mm / Capacity in 165 mm height drawers / Capacité des tiroirs de 165 mm de haut	50 kg
Capacidad cajones de altura 105 mm / Capacity in 105 mm height drawers / Capacité des tiroirs de 105 mm de haut	40 kg
Capacidad cajones de altura 45 mm / Capacity in 45 mm height drawers / Capacité des tiroirs de 45 mm de haut	30 kg
2 ruedas fijas y 2 giratorias con freno / 2 fixed and 2 revolving with brake wheels / 2 roues fixes et 2 roues giratoires avec frein	5" x 2"
Colgador lateral para herramientas / Lateral tool holder / Rangement latéral d'outils	●

■ 722 × 482 × 1013

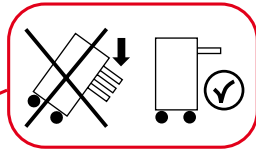



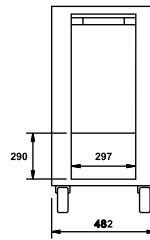
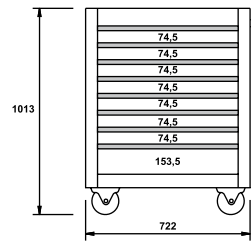

Sistema OODO Antivuelco  
OODO Antiovertum System  
(Only One Drawer Open)  
Système OODO Anti-renversement

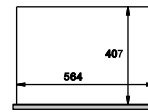

Disponible en 4 colores  
Available in 4 colors  
Disponible en 4 couleurs



COD.	L x W x H (mm)		Color / Colour / Couleur
50977	722 x 482 x 1013	73	
50978			
50979			
50980			

#### ESPECIFICACIONES TÉCNICAS / TECHNICAL SPECIFICATION / DÉTAILS TECHNIQUES

2 ruedas fijas y 2 giratorias con freno / 2 fixed and 2 revolving with brake wheels / 2 roues fixes et 2 roues giratoires avec frein	5" x 2"
Sistema antivuelco en cada bandeja / Anti-vertum system in each drawers / Système anti-renversement dans chaque tiroir	●
Sistema de cierre centralizado / Central locking system / Système de fermeture centralisée	●
Capacidad cajon 564 x 407 x 153,5 mm / Drawer capacity 564 x 407 x 153,5 mm / Capacité du tiroir 564 x 407 x 153,5 mm	30 Kg
Capacidad cajones 564 x 407 x 74,5 mm / Drawer capacity 564 x 407 x 74,5 mm / Capacité des tiroirs de 564 x 407 x 74,5 mm	25 Kg
Capacidad de carga estática total / Total static weight capacity / Capacité totale de charge statique	500 kg
Cajones con rodamientos / Ball-bearing slides / Tiroirs à roulement	●
Estructura reforzada / Reinforced heavy duty structure / Structure renforcée	●
Papelera / Trash tray / Poubelle	●

# BE SAFE...BE EFFICIENT

## ■ 1110 × 480 × 1015

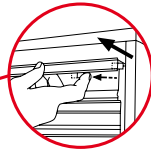





Sistema antivuelco con botón de seguridad de apertura individual por bandeja  
Anti-overtum system with individual safety open button in each tray  
Système anti-renversement avec bouton de sécurité d'ouverture individuelle par tiroir

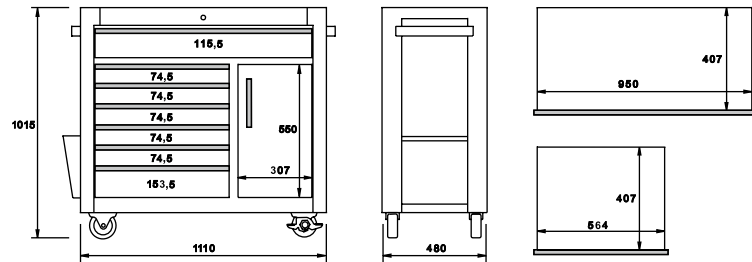

Disponible en 4 colores  
Available in 4 colors  
Disponible en 4 couleurs



COD.	L x W x H (mm)	Kg	Color / Colour / Couleur
50950	1110 x 480 x 1015	98	
50951			
50952			
50953			

**ESPECIFICACIONES TÉCNICAS / TECHNICAL SPECIFICATION / DÉTAILS TECHNIQUES**

2 ruedas fijas y 2 giratorias con freno / 2 fixed and 2 revolving with brake wheels / 2 roues fixes et 2 roues giratoires avec frein	5" x 2"
Sistema antivuelco en cada bandeja / Anti-overtum system in each drawers / Système anti-renversement dans chaque tiroir	●
Sistema de cierre centralizado / Central locking system / Système de fermeture centralisée	●
Capacidad cajón 950 x 407 x 115,5 mm / Drawer capacity 950 x 407 x 115,5 mm / Capacité du tiroir 950 x 407 x 115,5 mm	30 kg
Capacidad cajón 564 x 407 x 153,5 mm / Drawer capacity 564 x 407 x 153,5 mm / Capacité du tiroir 564 x 407 x 153,5 mm	30 Kg
Capacidad cajones 564 x 407 x 74,5 mm / Drawer capacity 564 x 407 x 74,5 mm / Capacité des tiroirs de 564 x 407 x 74,5 mm	25 Kg
Capacidad de carga estática total / Total static weight capacity / Capacité totale de charge statique	800 kg
7 cajones y 1 armario / 7 drawers and 1 closet / 7 tiroirs et une armoire	●
Estructura reforzada / Reinforced heavy duty structure / Structure renforcée	●
Papelera / Trash tray / Poubelle	●

# EGA Master



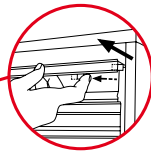

## ART IN INNOVATION



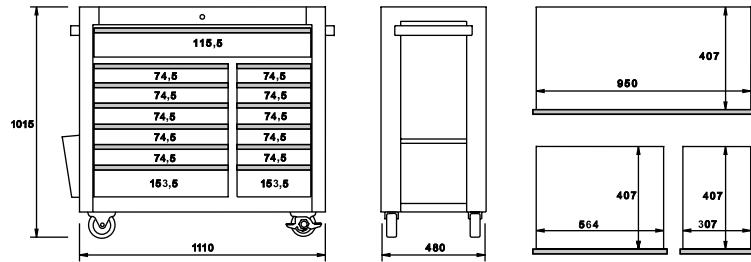

Sistema antivuelco con botón de seguridad de apertura individual por bandeja  
Anti-overturn system with individual safety open button in each tray  
Système anti-renversement avec bouton de sécurité d'ouverture individuelle par tiroir



COD.	L x W x H (mm)	Kg	Color / Colour / Couleur
50954	1110 x 480 x 1015	100	
50955			
50956			
50957			

#### ESPECIFICACIONES TÉCNICAS / TECHNICAL SPECIFICATION / DÉTAILS TECHNIQUES

2 ruedas fijas y 2 giratorias con freno / 2 fixed and 2 revolving with brake wheels / 2 roues fixes et 2 roues giratoires avec frein	5" x 2"
Sistema antivuelco en cada bandeja / Anti-overturn system in each drawers / Système anti-renversement dans chaque tiroir	●
Sistema de cierre centralizado / Central locking system / Système de fermeture centralisée	●
Capacidad cajón 950 x 407 x 115,5 mm / Drawer capacity 950 x 407 x 115,5 mm / Capacité du tiroir 950 x 407 x 115,5 mm	30 kg
Capacidad cajon 564 x 407 x 153,5 mm / Drawer capacity 564 x 407 x 153,5 mm / Capacité du tiroir 564 x 407 x 153,5 mm	30 Kg
Capacidad cajones 564 x 407 x 74,5 mm / Drawer capacity 564 x 407 x 74,5 mm / Capacité des tiroirs de 564 x 407 x 74,5 mm	25 Kg
Capacidad cajon 307 x 407 x 153,5 mm / Drawer capacity 307 x 407 x 153,5 mm / Capacité du tiroir 307 x 407 x 153,5 mm	25 Kg
Capacidad cajon 307 x 407 x 74,5 mm / Drawer capacity 307 x 407 x 74,5 mm / Capacité du tiroir 307 x 407 x 74,5 mm	20 Kg
Capacidad de carga estática total / Total static weight capacity / Capacité totale de charge statique	800 kg
13 cajones / 13 drawers / 13 tiroirs	●
Estructura reforzada / Reinforced heavy duty structure / Structure renforcée	●
Papelera / Trash tray / Poubelle	●

# BE SAFE...BE EFFICIENT

■ 1434 x 560 x 1075

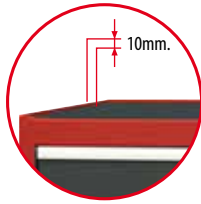

Zona de acople de seguridad para evitar que el cofre superior se caiga  
 Safety coupling area to prevent the upper chest to fall  
 Zone d'assemblage de sécurité pour éviter que le coffre supérieur tombe

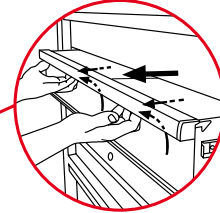

Sistema antivuelco con barra longitudinal de seguridad de apertura individual por bandeja  
 Anti-overturn system with individual safety open longitudinal bar in each tray  
 Système anti-renversement avec barre longitudinale de sécurité d'ouverture individuelle par tiroir

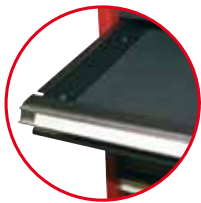

Protección de espuma EVA en cajones  
 Protecting EVA foam in drawer  
 Protection en mousse EVA dans les tiroirs

**6"x2"**  
**PARA MÁXIMA ESTABILIDAD**  
**FOR THE BEST STABILITY**  
**POUR UNE STABILITÉ, MAXIMALE**

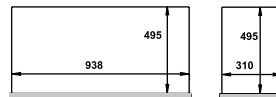
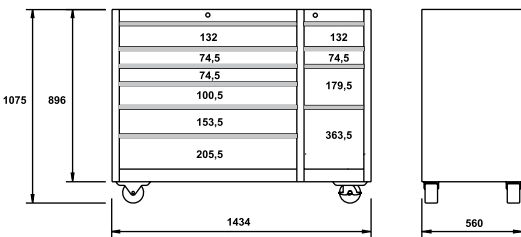

COD.	L x W x H (mm)	Kg	Color / Colour / Couleur
57060	1434 x 560 x 1075	174	
57048			
57088			
57068			

ESPECIFICACIONES TÉCNICAS / TECHNICAL SPECIFICATION / DÉTAILS TECHNIQUES	
2 ruedas fijas y 2 giratorias con freno / 2 fixed and 2 revolving with brake wheels / 2 roues fixes et 2 roues giratoires avec frein	6" x 2"
Sistema antivuelco en cada bandeja / Anti-overturn system in each drawers / Système anti-renversement dans chaque tiroir	●
Sistema de cierre centralizado / Central locking system / Système de fermeture centralisée	●
Capacidad cajón 938 x 495 x 205,5 mm / Drawer capacity 938 x 495 x 205,5 mm / Capacité du tiroir 938 x 495 x 205,5 mm	40 kg
Capacidad cajón 938 x 495 x 153,5 mm / Drawer capacity 938 x 495 x 153,5 mm / Capacité du tiroir 938 x 495 x 153,5 mm	35 kg
Capacidad cajón 938 x 495 x 132 mm / Drawer capacity 938 x 495 x 132 mm / Capacité du tiroir 938 x 495 x 132 mm	30 Kg
Capacidad cajón 938 x 495 x 100,5 mm / Drawer capacity 938 x 495 x 100,5 mm / Capacité du tiroir 938 x 495 x 100,5 mm	25 kg
Capacidad cajones 938 x 495 x 74,5 mm / Drawer capacity 938 x 495 x 74,5 mm / Capacité des tiroirs de 938 x 495 x 74,5 mm	20 Kg
Capacidad cajón 310 x 495 x 363,5 mm / Drawer capacity 310 x 495 x 363,5 mm / Capacité du tiroir 310 x 495 x 363,5 mm	40 Kg
Capacidad cajón 310 x 495 x 179,5 mm / Drawer capacity 310 x 495 x 179,5 mm / Capacité du tiroir 310 x 495 x 179,5 mm	30 Kg
Capacidad cajón 310 x 495 x 132 mm / Drawer capacity 310 x 495 x 132 mm / Capacité du tiroir 310 x 495 x 132 mm	25 Kg
Capacidad cajón 310 x 495 x 74,5 mm / Drawer capacity 310 x 495 x 74,5 mm / Capacité du tiroir 310 x 495 x 74,5 mm	20 Kg
Capacidad de carga estática total / Total static weight capacity / Capacité totale de charge statique	400 kg
10 cajones / 10 drawers / 10 tiroirs	●
Estructura reforzada / Reinforced heavy duty structure / Structure renforcée	●
Equipable con rueda motorizada 51648 / Equippable with 51648 driving kit / Équipé d'une roue motorisée 51648	●

■ 1434 × 560 × 1720

Zona de acople de seguridad para evitar que el cofre superior se caiga  
*Safety coupling area to prevent the upper chest to fall*  
Zone d'assemblage de sécurité pour éviter que le coffre supérieur tombe

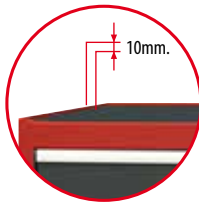

Protección de espuma EVA en cajones  
*Protecting EVA foam in drawer*  
Protection en mousse EVA dans les tiroirs

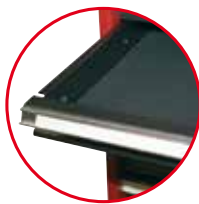

Sistema antivuelco con barra longitudinal de seguridad de apertura individual por bandeja  
*Anti-overturn system with individual safety open longitudinal bar in each tray*  
Système anti-renversement avec barre longitudinale de sécurité d'ouverture individuelle par tiroir

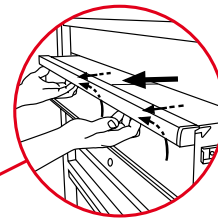

**6" x 2"**  
**PARA MÁXIMA ESTABILIDAD**  
**FOR THE BEST STABILITY**  
**POUR UNE STABILITÉ MAXIMALE**

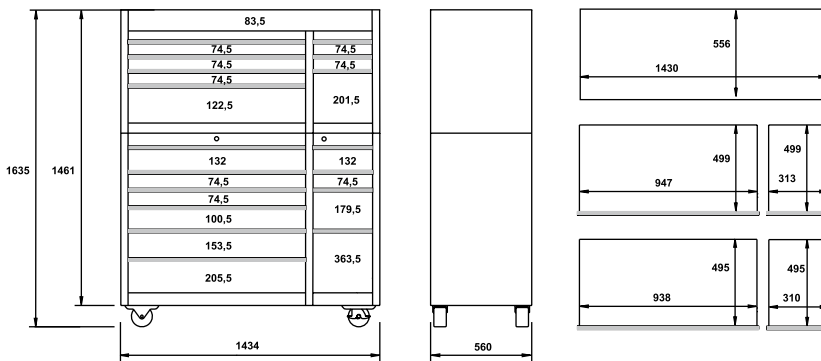

COD.	L x W x H (mm)			Color / Colour / Couleur	
51074	1434 x 560 x 1720		57060	51061	293
51517			57048	57049	
51520			57088	57089	
51523			57068	57069	

**ESPECIFICACIONES TÉCNICAS / TECHNICAL SPECIFICATION / DÉTAILS TECHNIQUES**

2 ruedas fijas y 2 giratorias con freno / 2 fixed and 2 revolving with brake wheels / 2 roues fixes et 2 roues giratoires avec frein	6" x 2"
Sistema antivuelco en cada bandeja / Anti-overflow system in each drawers / Système anti-renversement dans chaque tiroir	●
Sistema de cierre centralizado / Central locking system / Système de fermeture centralisée	●
Capacidad cajón 1430 x 556 x 83,5 mm / Drawer capacity 1430 x 556 x 83,5 mm / Capacité du tiroir 1430 x 556 x 83,5 mm	35 Kg
Capacidad cajón 947 x 499 x 122,5 mm / Drawer capacity 947 x 499 x 122,5 mm / Capacité du tiroir 947 x 499 x 122,5 mm	40 kg
Capacidad cajones 947 x 499 x 74,5 mm / Drawer capacity 947 x 499 x 74,5 mm / Capacité des tiroirs de 947 x 499 x 74,5 mm	30 kg
Capacidad cajón 938 x 495 x 205,5 mm / Drawer capacity 938 x 495 x 205,5 mm / Capacité du tiroir 938 x 495 x 205,5 mm	45 Kg
Capacidad cajón 938 x 495 x 153,5 mm / Drawer capacity 938 x 495 x 153,5 mm / Capacité du tiroir 938 x 495 x 153,5 mm	40 Kg
Capacidad cajón 938 x 495 x 132 mm / Drawer capacity 938 x 495 x 132 mm / Capacité du tiroir 938 x 495 x 132 mm	35 Kg
Capacidad cajón 938 x 495 x 100,5 mm / Drawer capacity 938 x 495 x 100,5 mm / Capacité du tiroir 938 x 495 x 100,5 mm	30 Kg
Capacidad cajones 938 x 495 x 74,5 mm / Drawer capacity 938 x 495 x 74,5 mm / Capacité des tiroirs de 938 x 495 x 74,5 mm	20 Kg
Capacidad cajón 313 x 499 x 201,5 mm / Drawer capacity 313 x 499 x 201,5 mm / Capacité du tiroir 313 x 499 x 201,5 mm	35 Kg
Capacidad cajones 313 x 499 x 74,5 mm / Drawer capacity 313 x 499 x 74,5 mm / Capacité des tiroirs de 313 x 499 x 74,5 mm	20 Kg
Capacidad cajón 310 x 495 x 363,5 mm / Drawer capacity 310 x 495 x 363,5 mm / Capacité du tiroir 310 x 495 x 363,5 mm	45 Kg
Capacidad cajón 310 x 495 x 179,5 mm / Drawer capacity 310 x 495 x 179,5 mm / Capacité du tiroir 310 x 495 x 179,5 mm	30 Kg
Capacidad cajón 310 x 495 x 132 mm / Drawer capacity 310 x 495 x 132 mm / Capacité du tiroir 310 x 495 x 132 mm	25 Kg
Capacidad cajón 310 x 495 x 74,5 mm / Drawer capacity 310 x 495 x 74,5 mm / Capacité du tiroir 310 x 495 x 74,5 mm	20 Kg
Capacidad de carga estática total / Total static weight capacity / Capacité totale de charge statique	660 kg
17 cajones con rodamientos / 17 drawer with ball bearings / 17 tiroirs à roulement	●
Estructura reforzada / Reinforced heavy duty structure / Structure renforcée	●
Equipable con rueda motorizada 51648 / equippable with 51648 driving kit / Équipé d'une roue motorisée 51648	●

**RUEDA MOTORIZADA / MOTORIZED WHEEL / ROUE MOTORISÉE / MOTORISIERTES RAD / RUOTA MOTORIZZATA / RODA MOTORIZADA / ПРИВОДНОЕ КОЛЕСО**
**KIT DE RUEDA MOTORIZADA / MOTORIZED WHEEL KIT / KIT DE ROUE MOTORISÉE / MOTORISIERTES RADSATZ / KIT RUOTA MOTORIZZATA / KIT DE RODA MOTORIZADA / КОМПЛЕКТ ПРИВОДНОГО КОЛЕСА**

COD.	V	L x W x H (mm)	
<b>87997</b>	24V	280 x 185 x 140	6,0

12M

**EQUIPADO CON / EQUIPED WITH / EQUIPE**

Actuador / Actuator / Actionneur

Unidad de control / Control box / Unité de contrôle

Cargador / Charger / Chargeur

Mando / Handle / Commande

Cable / Cable / Câble

Batería / Battery / Batterie

**REPUESTOS / SPARE PARTS / RECHANGES / ERSATZTEILE / ACCESSORI / ACESSORIOS / ЗАПАСНЫЕ ЧАСТИ**

COD.	Descripción / Description / Description	V	L x W x H (mm)	
<b>87996</b>	Batería / Battery / Batterie	24V	380 x 95 x 85	2,5

**KIT DE RUEDA MOTORIZADA (MONTAJE EN CARRO INCLUIDO) / MOTORIZED WHEEL KIT (INCLUDED ASSEMBLY IN CABINET) / KIT DE ROUE MOTORISÉE (MONTAGE SUR SERVANTE INCLUS) / MOTORISIERTES RAD-KIT (MONTAGE IM SCHRANK ENTHALTEN) / KIT RUOTA MOTORIZZATA (MONTAGGIO SU CARRELLO INCLUSO) / KIT DE RODA MOTORIZADA (MONTAGEM EM CARRO INCLUÍDA) / КОМПЛЕКТ ПРИВОДНОГО КОЛЕСА (МОНТАЖ КОЛЕСА К ТЕЛЕЖКЕ ВКЛЮЧЁН)**

COD.	PCS.	
<b>51648</b>	2	9,5

12M | Montaje en carro incluido / Included assembly in cabinet / Montage sur servante inclus

PCS.	Composición / Composition / Composition	Descripción / Description / Description
1	87997	Conjunto rueda motorizada / Motorized wheel kit
	87998	Soporte batería litio rueda motorizada / Lithium-ion battery holder for motorized wheel







**ESTANTERIAS MÓVILES CON MÉNSULAS / TROLLEYS WITH SHELVES / RAYONNAGES MOBILES AVEC ÉTAGÈRES / MOBILE REGALE MIT KONSOLEN / SCAFFALI MOBILI CON MENSOLE / ESTANTE MÓVEL COM PRATELEIRAS / ТЕЛЕЖКА С ПОЛКАМИ**
**COMPONENTES / COMPONENTS / COMPOSANTS / KOMPONENTEN / COMPONENTI / COMPONENTES / КОМПОНЕНТЫ**
**ESTRUCTURAS / FRAMES / STRUCTURES / GESTELL / STRUTTURA / ESTRUTURA / ТЕЛЕЖКА С РАМОЙ**

COD.	L x W x H (mm)	Kg-MAX 	Kg 
50093	725x613x1430	300	25
50088	1023x613x1430		28



**ESPECIFICACIONES TÉCNICAS / TECHNICAL SPECIFICATION / DÉTAILS TECHNIQUES**

2 ruedas fijas y 2 giratorias con freno / 2 fixed and 2 revolving with brake wheels / 2 roues fixes et 2 roues giratoires avec frein

**MÉNSULAS / SHELVES / ÉTAGÈRES / KONSOLEN / MENSOLE / PRATELEIRAS / ПОЛКИ**

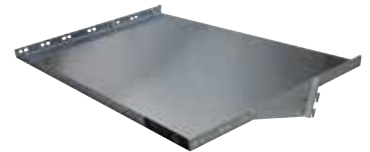
COD.	L x W x H (mm)	Kg-MAX 	Kg 	Válido para / Valid for / Valable pour
50095	657x220x30	50	2,3	50093
50094	657x420x30		3,4	
50090	955x320x30		4	
50089	955x600x30		7	

**COMBINACIONES / COMBINATIONS / COMBINAISONS / KOMBINATIONEN / COMBINAZIONI / COMBINAÇÕES / КОМПЛЕКТЫ**
**725 MM**
**PROFUNDIDAD DE 220 MM / 220 MM DEPTH / PROFONDEUR DE 220 MM / 220 MM TIEFE / PROFONDITÀ DI 220 MM / PROFUNDIDADE DE 220 MM / ГЛУБИНА 220 MM**

COD.	L x W x H (mm)			Kg 
50140	725x613x1430	2 x 50095	50093	29
50141		3 x 50095		32
50142		4 x 50095		34

**ESPECIFICACIONES TÉCNICAS / TECHNICAL SPECIFICATION / DÉTAILS TECHNIQUES**



2 ruedas fijas y 2 giratorias con freno / 2 fixed and 2 revolving with brake wheels / 2 roues fixes et 2 roues giratoires avec frein

Capacidad de carga estática total / Total static weight capacity / Capacité totale de charge statique

4"

300 kg

**PROFUNDIDAD DE 420 MM / 420 MM DEPTH / PROFONDEUR DE 420 MM / 420 MM TIEFE / PROFONDITÀ DI 420 MM / PROFUNDIDADE DE 420 MM / ГЛУБИНА 420 MM**

COD.	L x W x H (mm)			Kg 
50143	725x613x1430	2 x 50094	50093	32
50144		3 x 50094		35
50145		4 x 50094		38

**ESPECIFICACIONES TÉCNICAS / TECHNICAL SPECIFICATION / DÉTAILS TECHNIQUES**

2 ruedas fijas y 2 giratorias con freno / 2 fixed and 2 revolving with brake wheels / 2 roues fixes et 2 roues giratoires avec frein

Capacidad de carga estática total / Total static weight capacity / Capacité totale de charge statique



4"

300 kg



## 1023 MM

**PROFUNDIDAD DE 320 MM / 320 MM DEPTH / PROFONDEUR DE 320 MM / 320 MM TIEFE / PROFONDITÀ DI 320 MM / PROFUNDIDADE DE 320 MM / ГЛУБИНА 320 MM**

COD.	L x W x H (mm)			
50149		2 x 50090		37
50150	1023x613x1430	3 x 50090	50088	41
50151		4 x 50090		45

**ESPECIFICACIONES TÉCNICAS / TECHNICAL SPECIFICATION / DÉTAILS TECHNIQUES**



2 ruedas fijas y 2 giratorias con freno / 2 fixed and 2 revolving with brake wheels / 2 roues fixes et 2 roues giratoires avec frein

4"

Capacidad de carga estática total / Total static weight capacity / Capacité totale de charge statique

300 kg

**PROFUNDIDAD DE 600 MM / 600 MM DEPTH / PROFONDEUR DE 600 MM / 600 MM TIEFE / PROFONDITÀ DI 600 MM / PROFUNDIDADE DE 600 MM / ГЛУБИНА 600 MM**

COD.	L x W x H (mm)			
50152		2 x 50089		42
50153	1023x613x1430	3 x 50089	50088	49
50154		4 x 50089		55

**ESPECIFICACIONES TÉCNICAS / TECHNICAL SPECIFICATION / DÉTAILS TECHNIQUES**

2 ruedas fijas y 2 giratorias con freno / 2 fixed and 2 revolving with brake wheels / 2 roues fixes et 2 roues giratoires avec frein

4"

Capacidad de carga estática total / Total static weight capacity / Capacité totale de charge statique

300 kg

**ARCONES Y COFRES / JOBSITE BOXES AND CHESTS / COFFRES MÉTALLIQUES / WERKZEUGKISTEN AUS STAHL / CASSETTIERE PORTATILE IN METALLO / CAIXAS E BAÚS PARA FERRAMENTA / ЯЩИКИ И СУНДУКИ**
**COFRES PORTAHERRAMIENTAS DE SUPERFICIES INOX\* / INOX SURFACE TOOL CHEST\* / COFFRE À TIROIRS AVEC SURFACE INOX\* / WERKSTÄTTKASTEN MIT INOX OBERFLÄCHE\* / CASSETTI PORTAUTENSILI DI SUPERFICI INOX\* / BAÚ PORTA-FERRAMENTAS DE SUPERFÍCIE INOX\* / ПОРТАТИВНЫЕ ЯЩИКИ С ПОКРЫТИЕМ ИЗ НЕРЖАВЕЮЩЕЙ СТАЛИ\***

## 680 x 470 x 485

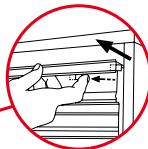
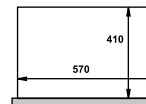
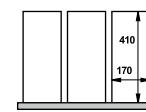
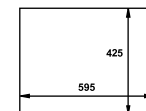
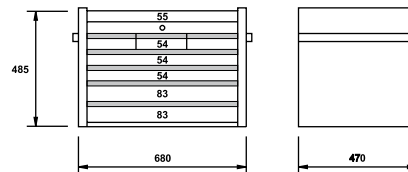
 Sistema antivuelco con botón de seguridad de apertura individual por bandeja  
 Anti-overflow system with individual safety open button in each tray  
 Système anti-renversement avec bouton de sécurité d'ouverture individuelle par tiroir

COD.	L x W x H (mm)	Material estructura / Material structure / Structure matériaux	
51560	680 x 470 x 485	Inox 430	45,5

INOX

**ESPECIFICACIONES TÉCNICAS / TECHNICAL SPECIFICATION / DÉTAILS TECHNIQUES**

Material* / Material* / Matière*	Exterior: 100% INOX – Interior: Acero pintado / Exterior 100% INOX – Interior: Painted Steel / Extérieur 100% INOX - Intérieur: Acier peint
Cajones con rodamientos / Ball-bearing slides / Tiroirs à roulement	7
Capacidad cajones de altura 55 mm / Capacity in 55 mm height drawers / Capacité des tiroirs de 55 mm de haut	20 kg
Capacidad cajones 170 x 410 x 54 mm / Drawer capacity 170 x 410 x 54 mm / Capacité des tiroirs de 170 x 410 x 54 mm	15 kg
Capacidad cajones 570 x 410 x 54 mm / Drawer capacity 570 x 410 x 54 mm / Capacité des tiroirs de 570 x 410 x 54 mm	25 kg
Capacidad cajones de altura 83 mm / Capacity in 83 mm height drawers / Capacité des tiroirs de 83 mm de haut	25 kg
Capacidad de carga estática total / Total static weight capacity / Capacité totale de charge statique	150 kg
Sistema de cierre centralizado / Central locking system / Système de fermeture centralisée	●
Asa lateral reforzada / Reinforced side handle / Poignées latérale renforcée	●
Sistema antivuelco en cada bandeja / Anti-overturn system in each drawers / Système anti-renversement dans chaque tiroir	●
Tapa con doble pistón neumático / Double pneumatic absorber equipped lid / Couvercle avec double piston pneumatique	●

**1056 x 470 x 576**

Sistema antivuelco con botón de seguridad de apertura individual por bandeja

Anti-overturn system with individual safety open button in each tray

Système anti-renversement avec bouton de sécurité d'ouverture individuelle par tiroir

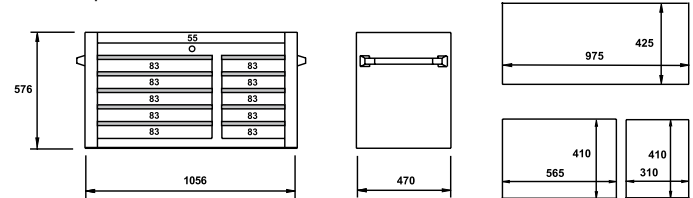

COD.	L x W x H (mm)	Material estructura / Material structure / Structure matériaux	 Kg
51562	1056 x 470 x 576	Inox 430	95

**ESPECIFICACIONES TÉCNICAS / TECHNICAL SPECIFICATION / DÉTAILS TECHNIQUES**

Material* / Material* / Matière*	Exterior: 100% INOX – Interior: Acero pintado / Exterior 100% INOX – Interior: Painted Steel / Extérieur 100% INOX - Intérieur: Acier peint
Cajones con rodamientos / Ball-bearing slides / Tiroirs à roulement	10
Capacidad cajones de altura 55 mm / Capacity in 55 mm height drawers / Capacité des tiroirs de 55 mm de haut	30 kg
Capacidad cajón 310 x 410 x 83 mm / Drawer capacity 310 x 410 x 83 mm / Capacité du tiroir 310 x 410 x 83 mm	25 kg
Capacidad cajón 565 x 410 x 83 mm / Drawer capacity 565 x 410 x 83 mm / Capacité du tiroir 565 x 410 x 83 mm	25 kg
Capacidad de carga estática total / Total static weight capacity / Capacité totale de charge statique	200 kg
Sistema de cierre centralizado / Central locking system / Système de fermeture centralisée	●
Asa lateral reforzada / Reinforced side handle / Poignées latérale renforcée	●
Sistema antivuelco en cada bandeja / Anti-overturn system in each drawers / Système anti-renversement dans chaque tiroir	●

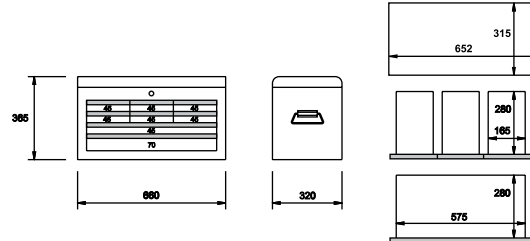
**COFRE PORTAHERRAMIENTAS / TOOL CHEST / COFFRE À TIROIRS / WERKSTATT KASTEN MIT SCHUBLADEN / CASSETTIERE PORTAUTENSILI / BAÚS DE FERRAMENTAS / ЯЩИКИ ДЛЯ ИНСТРУМЕНТА**
**660 × 320 × 365**

COD.	L x W x H (mm)	Kg	Color / Colour / Couleur
51011	660 x 320 x 365	24	
51480			
51492			
51504			

**ESPECIFICACIONES TÉCNICAS / TECHNICAL SPECIFICATION / DÉTAILS TECHNIQUES**

Cajones con rodamientos / Ball-bearing slides / Tiroirs à roulement	●
Cerradura con llave / Key lock / Serrure avec clé	●
Capacidad cajon 575 x 280 x 70 mm / Drawer capacity 575 x 280 x 70 mm / Capacité du tiroir 575 x 280 x 70 mm	20 Kg
Capacidad cajon 575 x 280 x 45 mm / Drawer capacity 575 x 280 x 45 mm / Capacité du tiroir 575 x 280 x 45 mm	10 Kg
Capacidad cajones 165 x 280 x 45 mm / Drawer capacity 165 x 280 x 45 mm / Capacité du tiroir 165 x 280 x 45 mm	9 Kg
Asas laterales / Lateral handles / Anses latérales	●

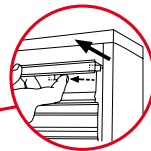
**730 × 475 × 475**

Sistema antivuelco con botón de seguridad de apertura individual por bandeja  
Anti-ouvertum system with individual safety open button in each tray  
Système anti-renversement avec bouton de sécurité d'ouverture individuelle par tiroir

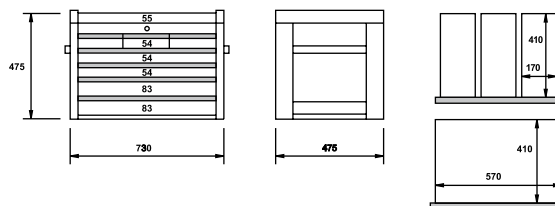

COD.	L x W x H (mm)	Kg	Color / Colour / Couleur
51075	730 x 475 x 475	47	
51490			
51502			
51514			

**ESPECIFICACIONES TÉCNICAS / TECHNICAL SPECIFICATION / DÉTAILS TECHNIQUES**

7 cajones con rodamientos / 7 ball-bearing slides / 7 tiroirs à roulement	●
Capacidad cajones de altura 83 mm / Capacity in 83 mm height drawers / Capacité des tiroirs de 83 mm de haut	25 kg
Capacidad cajones de altura 55 mm / Capacity in 55 mm height drawers / Capacité des tiroirs de 55 mm de haut	20 kg
Capacidad cajones 570 x 410 x 54 mm / Drawer capacity 570 x 410 x 54 mm / Capacité des tiroirs de 570 x 410 x 54 mm	20 kg
Capacidad cajones 170 x 410 x 54 mm / Drawer capacity 170 x 410 x 54 mm / Capacité des tiroirs de 170 x 410 x 54 mm	15 kg
Capacidad de carga estática total / Total static weight capacity / Capacité totale de charge statique	140 kg
Sistema de cierre centralizado / Central locking system / Système de fermeture centralisée	●
Sistema antivuelco en cada bandeja / Anti-ouvertum system in each drawers / Système anti-renversement dans chaque tiroir	●
Estructura reforzada / Reinforced heavy duty structure / Structure renforcée	●
Asas laterales / Lateral handles / Anses latérales	●





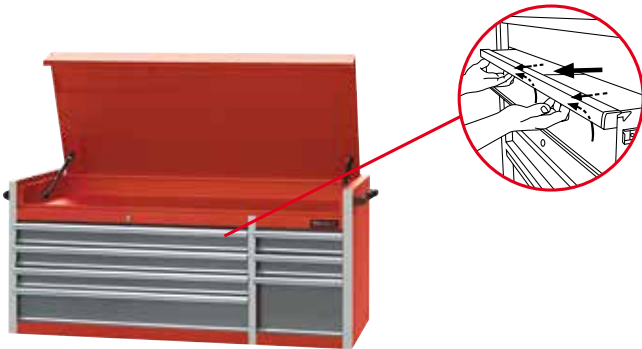

■ 1434 x 560 x 549

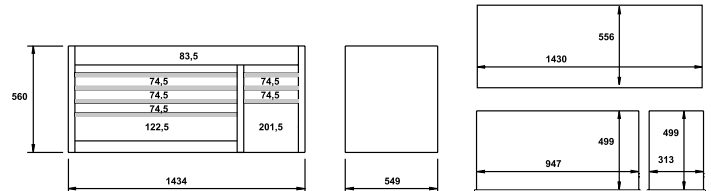

Sistema antivuelco con barra longitudinal de seguridad de apertura individual por bandeja  
*Anti-overturn system with individual safety open longitudinal bar in each tray*  
 Système anti-renversement avec barre longitudinale de sécurité d'ouverture individuelle par tiroir



COD.	L x W x H (mm)	Kg	Color / Colour / Couleur
57061	1434 x 560 x 549	130	
57049			
57089			
57069			

#### ESPECIFICACIONES TÉCNICAS / TECHNICAL SPECIFICATION / DÉTAILS TECHNIQUES

7 cajones con rodamientos / 7 ball-bearing slides / 7 tiroirs à roulement	●
Estructura reforzada / Reinforced heavy duty structure / Structure renforcée	●
Sistema antivuelco en cada bandeja / Anti-overturn system in each drawers / Système anti-renversement dans chaque tiroir	●
Cerradura con llave / Key lock / Serrure avec clé	●
Tapa con doble pistón neumático / Double pneumatic absorber equipped lid / Couvercle avec double piston pneumatique	●
Capacidad de carga estática total / Total static weight capacity / Capacité totale de charge statique	260 kg
Capacidad cajones 947 x 499 x 74,5 mm / Drawer capacity 947 x 499 x 74,5 mm / Capacité des tiroirs de 947 x 499 x 74,5 mm	30 kg
Capacidad cajón 947 x 499 x 122,5 mm / Drawer capacity 947 x 499 x 122,5 mm / Capacité du tiroir 947 x 499 x 122,5 mm	40 kg
Capacidad cajones 313 x 499 x 74,5 mm / Drawer capacity 313 x 499 x 74,5 mm / Capacité des tiroirs de 313 x 499 x 74,5 mm	25 kg
Capacidad cajón 313 x 499 x 201,5 mm / Drawer capacity 313 x 499 x 201,5 mm / Capacité du tiroir 313 x 499 x 201,5 mm	40 kg
Asas laterales / Lateral handles / Anses latérales	●
Sistema de cierre centralizado / Central locking system / Système de fermeture centralisée	●

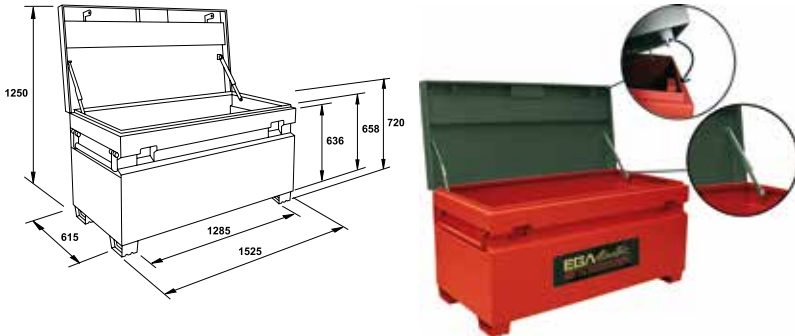

**ARCONES METÁLICOS / METALLIC JOBSITE BOXES / COFFRES METALLIQUES / METALLARBEITSCHRÄNKE / CASSONI METALLICI / BAÚS METÁLICOS / МЕТАЛЛИЧЕСКИЕ ЯЩИКИ ДЛЯ ИНСТРУМЕНТОВ**
**1525 × 615 × 720**

COD.	L x W x H (mm)	Espesor general (mm) / General thickness (mm) / Épaisseur générale (mm)	Espesor base (mm) / Base thickness (mm) / Épaisseur de base (mm)	Kg - MAX	Kg
50989	1525 x 615 x 720	1,5	2,5	300	74

**ESPECIFICACIONES TÉCNICAS / TECHNICAL SPECIFICATION / DÉTAILS TECHNIQUES**

- Patatas especialmente diseñadas para transpalet / Prepared to be used with pallet truck / Coffres gerbables
- Fabricado en acero de alta calidad / Manufactured in high quality steel / Fabriqué en acier de haute qualité
- Cierre para candado / Prepared for padlock / Fermeture cadenas
- Asas laterales / Lateral handles / Anses latérales

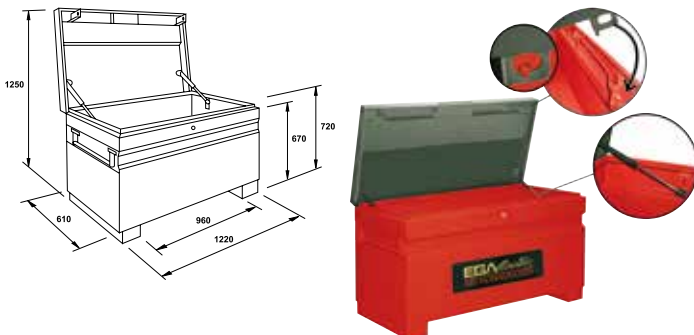
**1220 × 610 × 720**

COD.	L x W x H (mm)	Espesor general (mm) / General thickness (mm) / Épaisseur générale (mm)	Espesor base (mm) / Base thickness (mm) / Épaisseur de base (mm)	Kg - MAX	Kg
51046	1220 x 610 x 720	1,5	2,5	300	78

**ESPECIFICACIONES TÉCNICAS / TECHNICAL SPECIFICATION / DÉTAILS TECHNIQUES**

- Tapa con doble pistón neumático / Double pneumatic absorber equipped lid / Couvercle avec double piston pneumatique
- Refuerzos laterales / Lateral reinforcement / Renforcements latéraux
- Cerradura en el centro del panel frontal con juego de dos llaves / Central safety lock (2 keys) / Serrure centrale (2 clés)
- Patatas especialmente diseñadas para transpalet / Prepared to be used with pallet truck / Coffres gerbables
- Fabricado en acero de alta calidad / Manufactured in high quality steel / Fabriqué en acier de haute qualité
- Asas laterales / Lateral handles / Anses latérales



- Los arcones EGA Master están especialmente diseñados para poder estar contenidos el arcón de menor tamaño dentro del siguiente en dimensiones, esto es: / EGA Master jobsite boxes are specially designed to transport the smaller one into the next bigger one: / Les coffres EGA Master sont spécialement conçus pour contenir le coffre de dimension inférieure à l'intérieur:
  - código 51048 dentro del código 51047. / code 51048 into code 51047. / code 51048 à l'intérieur du code 51047.
  - código 51047 dentro del código 51046. / code 51047 into code 51046. / code 51047 à l'intérieur du code 51046.
- Esta ventaja permite reducir ampliamente los costes de transporte y ahorrar espacio de almacenamiento. / That allows reducing largely transport costs and saves storing space. / Cet avantage permet de réduire considérablement les coûts de transport et d'économiser l'espace de stockage.

## ■ 915 × 432 × 541

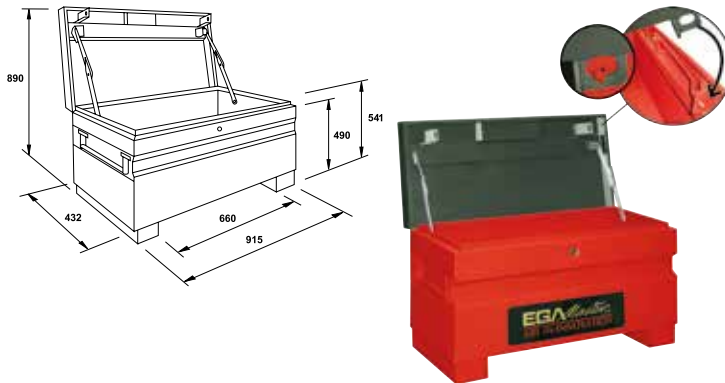

COD.	L x W x H (mm)	Espesor general (mm) / General thickness (mm) / Épaisseur générale (mm)	Espesor base (mm) / Base thickness (mm) / Épaisseur de base (mm)	Kg-MAX	Kg
51047	915 x 432 x 541	1,5	2,5	200	40

## ESPECIFICACIONES TÉCNICAS / TECHNICAL SPECIFICATION / DÉTAILS TECHNIQUES

Refuerzos laterales / Lateral reinforcement / Renforcements latéraux	●
Cerradura en el centro del panel frontal con juego de dos llaves / Central safety lock (2 keys) / Serrure centrale (2 clés)	●
Patas especialmente diseñadas para transpalet / Prepared to be used with pallet truck / Coffres gerbables	●
Fabricado en acero de alta calidad / Manufactured in high quality steel / Fabriqué en acier de haute qualité	●
Asas laterales / Lateral handles / Anses latérales	●

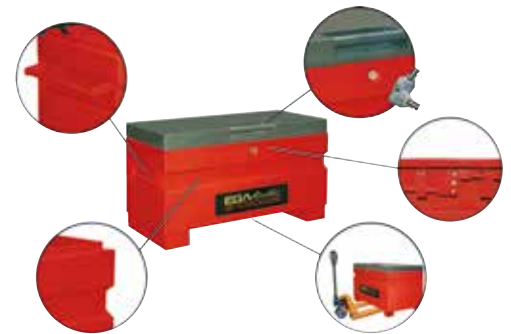

## ■ 720 × 315 × 282

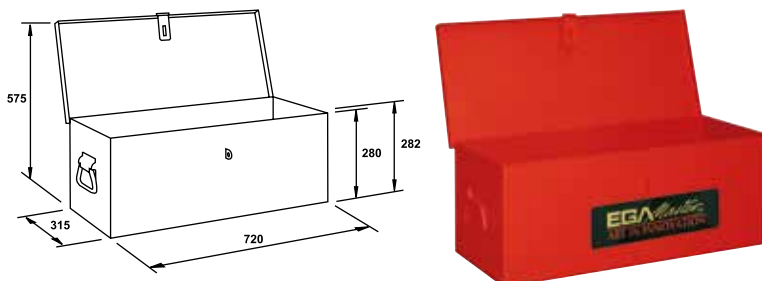

COD.	L x W x H (mm)	Espesor general (mm) / General thickness (mm) / Épaisseur générale (mm)	Kg-MAX	Kg
51048	720 x 315 x 282	1,5	80	13

## ESPECIFICACIONES TÉCNICAS / TECHNICAL SPECIFICATION / DÉTAILS TECHNIQUES

Fabricado en acero de alta calidad / Manufactured in high quality steel / Fabriqué en acier de haute qualité	●
Cierre para candado / Prepared for padlock / Fermeture cadenas	●
Asas laterales / Lateral handles / Anses latérales	●



- Los arcones EGA Master están especialmente diseñados para poder estar contenidos el arcón de menor tamaño dentro del siguiente en dimensiones, esto es: / EGA Master jobsite boxes are specially designed to transport the smaller one into the next bigger one: / Les coffres EGA Master sont spécialement conçus pour contenir le coffre de dimension inférieure à l'intérieur:
- código 51048 dentro del código 51047. / code 51048 into code 51047. / code 51048 à l'intérieur du code 51047.
- código 51047 dentro del código 51046. / code 51047 into code 51046. / code 51047 à l'intérieur du code 51046.
- Esta ventaja permite reducir ampliamente los costes de transporte y ahorrar espacio de almacenamiento. / That allows reducing largely transport costs and saves storing space. / Cet avantage permet de réduire considérablement les coûts de transport et d'économiser l'espace de stockage.

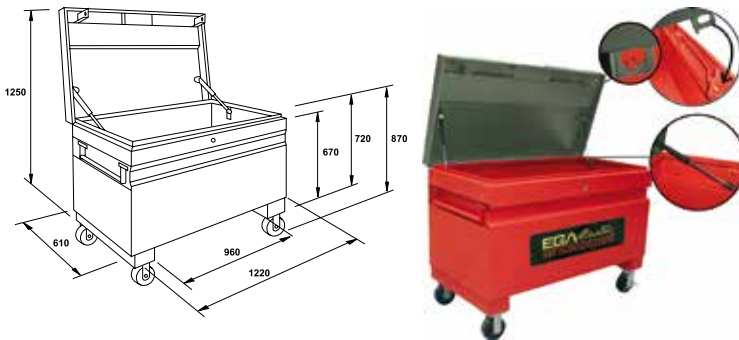

**ARCONES METÁLICOS CON RUEDAS / METALLIC JOBSITE BOXES WITH ROLLERS / COFFRES METALLIQUES À ROUES / METALLARBEITSCHRÄNKE MIT RÄDER / CASSONI METALLICI CON ROUTE / BAÚS METÁLICOS COM RODAS / МЕТАЛЛИЧЕСКИЕ КОНТЕЙНЕРЫ ДЛЯ ХРАНЕНИЯ ИНСТРУМЕНТА НА КОЛЕСАХ**
**1220 × 610 × 870**

COD.	L x W x H (mm)	Espesor general (mm) / General thickness (mm) / Épaisseur générale (mm)	Espesor base (mm) / Base thickness (mm) / Épaisseur de base (mm)	Kg-MAX	Kg
<b>50991</b>	1220 x 610 x 870	1,5	2,5	300	87

**ESPECIFICACIONES TÉCNICAS / TECHNICAL SPECIFICATION / DÉTAILS TECHNIQUES**

2 ruedas fijas y 2 giratorias con freno / 2 fixed and 2 revolving with brake wheels / 2 roues fixes et 2 roues giratoires avec frein	5" x 2"
Tapa con doble pistón neumático / Double pneumatic absorber equipped lid / Couvercle avec double piston pneumatique	●
Refuerzos laterales / Lateral reinforcement / Renforcements latéraux	●
Cerradura en el centro del panel frontal con juego de dos llaves / Central safety lock (2 keys) / Serrure centrale (2 clés)	●
Fabricado en acero de alta calidad / Manufactured in high quality steel / Fabriqué en acier de haute qualité	●
Asas laterales / Lateral handles / Anses latérales	●

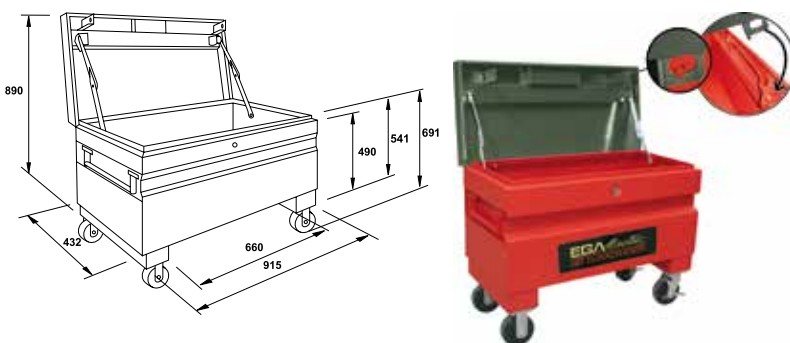
**915 × 432 × 691**

COD.	L x W x H (mm)	Espesor general (mm) / General thickness (mm) / Épaisseur générale (mm)	Espesor base (mm) / Base thickness (mm) / Épaisseur de base (mm)	Kg-MAX	Kg
<b>50992</b>	915 x 432 x 691	1,5	2,5	200	40

**ESPECIFICACIONES TÉCNICAS / TECHNICAL SPECIFICATION / DÉTAILS TECHNIQUES**

2 ruedas fijas y 2 giratorias con freno / 2 fixed and 2 revolving with brake wheels / 2 roues fixes et 2 roues giratoires avec frein	5" x 2"
Refuerzos laterales / Lateral reinforcement / Renforcements latéraux	●
Cerradura en el centro del panel frontal con juego de dos llaves / Central safety lock (2 keys) / Serrure centrale (2 clés)	●
Fabricado en acero de alta calidad / Manufactured in high quality steel / Fabriqué en acier de haute qualité	●
Asas laterales / Lateral handles / Anses latérales	●





**ARCONES GALVANIZADOS / GALVANIZED JOBSITE BOXES / COFFRES GALVANISÉS / VERZINKTE ARBEITS-KISTE / CASSONI GALVANIZZATI / BAÚS GALVANIZADOS / ИНСТРУМЕНТАЛЬНЫЙ ЯЩИК С ЗАЩИТНЫМ ПОКРЫТИЕМ**
**1140 X 370 X 380**

COD.	L x W x H (mm)	Espesor general (mm) / General thickness (mm) / Épaisseur générale (mm)	Kg-MAX	Kg
<b>50939</b>	1140 x 370 x 380	0,6	45	12,5

**ESPECIFICACIONES TÉCNICAS / TECHNICAL SPECIFICATION / DÉTAILS TECHNIQUES**

Fabricado en acero galvanizado de alta calidad / *Manufactured in high quality galvanized steel* / Fabriqué en acier galvanisé d'haute qualité

Cierre para candado / *Prepared for padlock* / Fermeture cadenas

Asas laterales / *Lateral handles* / Anses latérales

**760 X 330 X 250**

COD.	L x W x H (mm)	Espesor general (mm) / General thickness (mm) / Épaisseur générale (mm)	Kg-MAX	Kg
<b>50938</b>	760 x 330 x 250	0,6	32	6,7

**ESPECIFICACIONES TÉCNICAS / TECHNICAL SPECIFICATION / DÉTAILS TECHNIQUES**

Fabricado en acero galvanizado de alta calidad / *Manufactured in high quality galvanized steel* / Fabriqué en acier galvanisé d'haute qualité

Cierre para candado / *Prepared for padlock* / Fermeture cadenas

Asas laterales / *Lateral handles* / Anses latérales

1 bandeja / *1 tray* / 1 plateau

**550 X 230 X 210**

COD.	L x W x H (mm)	Espesor general (mm) / General thickness (mm) / Épaisseur générale (mm)	Kg-MAX	Kg
<b>50937</b>	550 x 230 x 210	0,5	20	2,5

**ESPECIFICACIONES TÉCNICAS / TECHNICAL SPECIFICATION / DÉTAILS TECHNIQUES**

Fabricado en acero galvanizado de alta calidad / *Manufactured in high quality galvanized steel* / Fabriqué en acier galvanisé d'haute qualité

Cierre para candado / *Prepared for padlock* / Fermeture cadenas

Asas laterales / *Lateral handles* / Anses latérales

- Los arcones EGA Master están especialmente diseñados para poder estar contenidos el arcón de menor tamaño dentro del siguiente en dimensiones, esto es: *EGA Master jobsite boxes are specially designed to transport the smaller one into the next bigger one* / Les coffres EGA Master sont spécialement conçus pour contenir le coffre de dimension inférieure à l'intérieur.
- código 50937 dentro del código 50938. / *code 50937 into code 50938*. / code 50937 à l'intérieur du code 50938.
- código 50938 dentro del código 50939. / *code 50938 into code 50939*. / code 50938 à l'intérieur du code 50939.
- Esta ventaja permite reducir ampliamente los costes de transporte y ahorrar espacio de almacenamiento. / *That allows reducing largely transport costs and saves storing space*. / Cet avantage permet de réduire considérablement les coûts de transport et d'économiser l'espace de stockage.



**MALETAS, CAJAS DE HERRAMIENTAS Y ACCESORIOS / TOOL BOXES AND ACCESSORIES / VALISES, CAISSES À OUTILS ET ACCESSOIRES / WERKZEUGKOFFER UND ZUBEHÖR / VALIGIE, CASSETTE PORTAUTENSILI ED ACCESSORI / MALAS, CAIXAS E ACESSÓRIOS / ЧЕМОДАНЫ, ЯЩИКИ ДЛЯ ИНСТРУМЕНТОВ И ЗАПАСНЫЕ ЧАСТИ**
**MALETA DE ALUMINIO PORTAHERRAMIENTAS / ALUMINIUM TOOL CASE / MALLETTE PORTE-OUTILS / ALUMINIUMKOFFER ZUM ROLLEN / VALIGIA PORTAUTENSILI IN ALLUMINO / MALA DE ALUMINIO PORTAFERRAMENTAS / АЛЮМИНИЕВЫЙ ИНСТРУМЕНТАЛЬНЫЙ КЕЙС**
**1350 × 356 × 114**

COD.	L x W x H (mm)	Kg-MAX	Kg
<b>51055</b>	1350 x 356 x 114	18	7,5

**ESPECIFICACIONES TÉCNICAS / TECHNICAL SPECIFICATION / DÉTAILS TECHNIQUES**

Cerradura con llave / Key lock / Serrure avec clé	●
Con cierres en zamak / Zinc alloy lockers / Casiers en alliage de zinc	●

**665 × 500 × 110**

COD.	L x W x H (mm)	Kg-MAX	Kg
<b>51054</b>	665 x 500 x 110	10	3,4

**650 × 250 × 115**

COD.	L x W x H (mm)	Kg-MAX	Kg
<b>50947</b>	650 x 250 x 115	10	3

**520 × 330 × 152**

COD.	L x W x H (mm)	Kg-MAX	Kg
<b>51056</b>	520 x 330 x 152	13	3,6

**ESPECIFICACIONES TÉCNICAS / TECHNICAL SPECIFICATION / DÉTAILS TECHNIQUES**

Cerradura con llave / Key lock / Serrure avec clé	●
Con cierres en zamak / Zinc alloy lockers / Casiers en alliage de zinc	●

**455 × 205 × 320**

COD.	L x W x H (mm)	Kg-MAX	Kg
<b>51012</b>	455 x 205 x 320	15	4,0

**ESPECIFICACIONES TÉCNICAS / TECHNICAL SPECIFICATION / DÉTAILS TECHNIQUES**

Ruedas / Wheels / Roues	●
Cerradura de combinación / Number combination lock / Fermeture sécurisée par combinaison	●
Asa telescópica / Telescopic handle / Anse télescopique	●

**450 X 300 X 85**

COD.	L x W x H (mm)	Kg-MAX	Kg
<b>50974</b>	450 x 300 x 85	5	1,5



## ■ 365 × 240 × 75

COD.	L x W x H (mm)	Kg-MAX	Kg
<b>51053</b>	365 x 240 x 75	5	1,2



## ■ 288 × 180 × 53

COD.	L x W x H (mm)	Kg-MAX	Kg
<b>51079</b>	288 x 180 x 53	5	0,6



## ■ 250 × 145 × 53

COD.	L x W x H (mm)	Kg-MAX	Kg
<b>51071</b>	250 x 145 x 53	5	0,4



## ■ MALETA PORTAHERRAMIENTAS / TOOL CASE / MALLETTTE PORTE-OUTILS / WERKZEUGKOFFER / VALIGIA PORTAUTENSILI / MALA PORTAFERRAMENTAS / КЕЙС ДЛЯ ИНСТРУМЕНТА

## ■ 470 × 355 × 160

COD.	L x W x H (mm)	Kg
<b>51010</b>	470 x 355 x 160	3,2

## ESPECIFICACIONES TÉCNICAS / TECHNICAL SPECIFICATION / DÉTAILS TECHNIQUES

Capacidad / Capacity / Capacité	15 kg
ABS extra resistente / Extra-resistant ABS / ABS extra-résistant	●
Cerradura con llave / Key lock / Serrure avec clé	●



## ■ 470 × 355 × 220

COD.	L x W x H (mm)	Kg
<b>50993</b>	470 x 355 x 220	5,0

## ESPECIFICACIONES TÉCNICAS / TECHNICAL SPECIFICATION / DÉTAILS TECHNIQUES

Ruedas / Wheels / Roues	●
Capacidad / Capacity / Capacité	15 kg
ABS extra resistente / Extra-resistant ABS / ABS extra-résistant	●
Cerradura con llave / Key lock / Serrure avec clé	●
Cerradura de combinación / Number combination lock / Fermeture sécurisée par combinaison	●
Resistencia / Resistance / Résistance	>90 kg
Asa telescópica / Telescopic handle / Anse télescopique	560 mm



**CARROS PORTAMALETAS / PLASTIC TOOL BOXES WITH TROLLEY / CHARIOTS PORTE-MAIETTES / WERKZEUGKÄSTEN AUS KUNSTSTOFF MIT WAGEN / TROLLEY PORTAUTENSILI A 2 MODULI / CAIXAS DE FERRAMENTA COM TROLLEY / КОМПЛЕКТ ПЛАСТИКОВЫХ КЕЙСОВ НА ТЕЛЕЖКЕ**
**470 × 290 × 630**

COD.	L x W x H (mm)	Kg
<b>50968</b>	470 x 290 x 630	4,1

**ESPECIFICACIONES TÉCNICAS / TECHNICAL SPECIFICATION / DÉTAILS TECHNIQUES**

Ruedas / <i>Wheels</i> / Roues	●
Capacidad / <i>Capacity</i> / Capacité	60 litros
Mat: PP	●
2 asas plegables / <i>2 folding handle</i> / 2 anses pliables	●
1 bandeja / <i>1 tray</i> / 1 plateau	●

**500 × 410 × 770**

COD.	L x W x H (mm)	Kg
<b>50966</b>	500 x 410 x 770	15

**ESPECIFICACIONES TÉCNICAS / TECHNICAL SPECIFICATION / DÉTAILS TECHNIQUES**

Cajones y tapa transparente / <i>Drawer and transparent cover</i> / Tiroir avec couvercle transparent	Poliestireno (PS) / <i>Polystyrene (PS)</i> / Polystyrène (PS)
1 maleta + 1 maleta con cajón / <i>1 case + 1 drawer case</i> / 1 mallette + 1 mallette avec tiroir	●
Ruedas / <i>Wheels</i> / Roues	●
Capacidad / <i>Capacity</i> / Capacité	40 kg
Estuche / <i>Case</i> / Étui	Dos de: 430 x 370 x 85 mm - Uno de: 430 x 370 x 55 mm
Cajas / <i>Boxes</i> / Caisses	55 x 39 x 47 mm (10 pcs) & 79 x 55 x 47 mm (10 pcs) & 109 x 79 x 47 mm (5 pcs) & 79 x 55 x 76 mm (5 pcs) & 109 x 79 x 76 mm (6 pcs) & 157 x 109 x 76 mm (2 pcs)
Mat: PP	●

**REPUESTOS / SPARE PARTS / RECHANGES / ERSATZTEILE / ACCESSORI / ACESSORIOS / ЗАПАСНЫЕ ЧАСТИ**
**ESTUCHE / CASE / COFFRET / FALL / VALIGIA / CASO / КЕЙС**

COD.	L x W x H (mm)	Válido para / <i>Valid for</i> / Valable pour
<b>89541</b>	430 x 370 x 55	50966
<b>89542</b>	430 x 370 x 85	





## CAJÓN / DRAWER / TIROIR / SCHUBLADE / CASSETTO / GAVETA / ЯЩИК

COD.	L x W x H (mm)	Válido para / Valid for / Valable pour
89535	55 x 39 x 47	50966
89536	79 x 55 x 47	
89537	109 x 79 x 47	
89538	79 x 55 x 76	
89539	109 x 79 x 76	
89540	157 x 109 x 76	



## MALETAS ROBUST / ROBUST CASES / VALISES ROBUST / ROBUSTER KOFFER / VALIGIE ROBUST / MALAS ROBUST / УДАРОПРОЧНЫЕ КЕЙСЫ

445 x 345 x 125

COD.	L x W x H (mm)	Kg
58590	445 x 345 x 125	3,4

## ESPECIFICACIONES TÉCNICAS / TECHNICAL SPECIFICATION / DÉTAILS TECHNIQUES

Bandeja portaherramientas / Tool tray / Plateau porte-outils	-
Grado de protección / Ingress protection / Grade de protection	IP67
Ruedas / Wheels / Roues	-



## MALETAS ROBUST CON RUEDAS / ROBUST CASES WITH TROLLEY / VALISES ROBUST À ROULETTES / ROBUSTER KOFFER MIT ROLLER / VALIGIE ROBUST CON RUOTE / TROLLEY ROBUST / УДАРОПРОЧНЫЙ КЕЙС С ТЕЛЕЖКОЙ

581 x 381 x 455



COD.	L x W x H (mm)	Kg
58594	581 x 381 x 455	15
58605		18

## ESPECIFICACIONES / SPECIFICATION / DÉTAILS

Bandeja portaherramientas / Tool tray / Plateau porte-outils	8 x 58620
Grado de protección / Ingress protection / Grade de protection	58594 IP67
	58605 -
Ruedas / Wheels / Roues	●

COD.	L x W x H (mm)	Kg
58595	581 x 381 x 455	14
58606		18

## ESPECIFICACIONES / SPECIFICATION / DÉTAILS

Bandeja portaherramientas / Tool tray / Plateau porte-outils	6 x 58620 + 1 x 58621
Grado de protección / Ingress protection / Grade de protection	58595 IP67
	58606 -
Ruedas / Wheels / Roues	●

COD.	L x W x H (mm)	
<b>58596</b>	581 x 381 x 455	14
<b>58607</b>		17

**ESPECIFICACIONES / SPECIFICATION / DÉTAILS**

Bandeja portaherramientas / Tool tray / Plateau porte-outils	4 x 58620 + 2 x 58621
Grado de protección / Ingress protection / Grade de protection	58596 IP67 58607 -
Ruedas / Wheels / Roues	●

COD.	L x W x H (mm)	
<b>58597</b>	581 x 381 x 455	14
<b>58608</b>		17

**ESPECIFICACIONES / SPECIFICATION / DÉTAILS**

Bandeja portaherramientas / Tool tray / Plateau porte-outils	2 x 58620 + 3 x 58621
Grado de protección / Ingress protection / Grade de protection	58597 IP67 58608 -
Ruedas / Wheels / Roues	●

COD.	L x W x H (mm)	
<b>58598</b>	581 x 381 x 455	13
<b>58609</b>		17

**ESPECIFICACIONES / SPECIFICATION / DÉTAILS**

Bandeja portaherramientas / Tool tray / Plateau porte-outils	4 x 58621
Grado de protección / Ingress protection / Grade de protection	58598 IP67 58609 -
Ruedas / Wheels / Roues	●

COD.	L x W x H (mm)	
<b>58599</b>	581 x 381 x 455	14
<b>58610</b>		17

**ESPECIFICACIONES / SPECIFICATION / DÉTAILS**

Bandeja portaherramientas / Tool tray / Plateau porte-outils	5 x 58620 + 1 x 58622
Grado de protección / Ingress protection / Grade de protection	58599 IP67 58610 -
Ruedas / Wheels / Roues	●

COD.	L x W x H (mm)	
<b>58600</b>	581 x 381 x 455	13
<b>58611</b>		17

**ESPECIFICACIONES / SPECIFICATION / DÉTAILS**

Bandeja portaherramientas / Tool tray / Plateau porte-outils	2 x 58620 + 2 x 58622
Grado de protección / Ingress protection / Grade de protection	58600 IP67 58611 -
Ruedas / Wheels / Roues	●

COD.	L x W x H (mm)	
<b>58601</b>	581 x 381 x 455	13
<b>58612</b>		16

**ESPECIFICACIONES / SPECIFICATION / DÉTAILS**

Bandeja portaherramientas / Tool tray / Plateau porte-outils	1 x 58621 + 2 x 58622
Grado de protección / Ingress protection / Grade de protection	58601 IP67 58612 -
Ruedas / Wheels / Roues	●

COD.	L x W x H (mm)	
<b>58602</b>	581 x 381 x 455	13
<b>58613</b>		17

**ESPECIFICACIONES / SPECIFICATION / DÉTAILS**

Bandeja portaherramientas / Tool tray / Plateau porte-outils	1 x 58620 + 2 x 58621 + 1 x 58622
Grado de protección / Ingress protection / Grade de protection	58602 IP67 58613 -
Ruedas / Wheels / Roues	●

COD.	L x W x H (mm)	
<b>58603</b>	581 x 381 x 455	14
<b>58614</b>		17

**ESPECIFICACIONES / SPECIFICATION / DÉTAILS**

Ruedas / Wheels / Roues	●
Bandeja portaherramientas / Tool tray / Plateau porte-outils	3 x 58620 + 1 x 58621 + 1 x 58622
Grado de protección / Ingress protection / Grade de protection	58603 IP67 58614 -

■ REPUESTOS / SPARE PARTS / RECHANGES / ERSATZTEILE / ACCESSORI / ACESSORIOS / ЗАПАСНЫЕ ЧАСТИ

■ BANDEJAS / TRAYS / PLATEAUX / ABLAGEKASTEN / PANNELLO / TABULEIROS / ПОДДОНЫ



COD.	L x W x H (mm)
<b>58620</b>	467 x 255 x 30



COD.	L x W x H (mm)
<b>58621</b>	467 x 255 x 60



COD.	L x W x H (mm)
<b>58622</b>	467 x 255 x 95

■ 670 x 510 x 372

COD.	L x W x H (mm)	 Kg	Grado de protección / Degree of protection / Grade de protection
<b>58592</b>	670 x 510 x 372	10,5	IP67

ESPECIFICACIONES TÉCNICAS / TECHNICAL SPECIFICATION / DÉTAILS TECHNIQUES

Bandeja portaherramientas / Tool tray / Plateau porte-outils	-
Grado de protección / Ingress protection / Grade de protection	IP67
Ruedas / Wheels / Roues	●



■ 546 x 347 x 247

COD.	L x W x H (mm)	 Kg	Grado de protección / Degree of protection / Grade de protection
<b>58591</b>	546 x 347 x 247	6,5	IP67

ESPECIFICACIONES TÉCNICAS / TECHNICAL SPECIFICATION / DÉTAILS TECHNIQUES

Bandeja portaherramientas / Tool tray / Plateau porte-outils	-
Grado de protección / Ingress protection / Grade de protection	IP67
Ruedas / Wheels / Roues	●
Asa telescópica / Telescopic handle / Anse télescopique	●



■ MOCHILA / BACKPACK / SAC À DOS / RUCKSACK / ZAINO / MOCHILA / РЮКЗАК

COD.	Válido para / Valid for / Valable pour
<b>58589</b>	58591



**MALETA ABS APILABLE Y CASI INDESTRUCTIBLE / ABS TOOL CASE STACKABLE AND ALMOST INDESTRUCTIBLE / VALISE ABS EMPILABLE ET PRESQUE INDESTRUCTIBLE / ABS-WERKZEUGKOFFER STAPELBAR UND FAST UNZERSTÖRBAR / VALIGIA IN ABS IMPILABILE E QUASI INDISTRUTTIBILE / MALA ABS EMPILHÁVEL E QUASE INDESTRUTÍVEL / СВЕРХПРОЧНЫЙ ШТАБЕЛИРУЕМЫЙ ЯЩИК АБС**

COD.	L x W x H (mm)	
<b>50994</b>	464 x 335 x 142	2,2

**ESPECIFICACIONES TÉCNICAS / TECHNICAL SPECIFICATION / DÉTAILS TECHNIQUES**

Capacidad / Capacity / Capacité	60 kg
ABS extra resistente / Extra-resistant ABS / ABS extra-résistant	Hasta 90 kg / Up to 90 kg / Jusqu'à 90 kg
Mat: PP	●
Apilables / Stackables / Empilables	●
Auto-basculante / Self-balancing / Auto-basculant	●
Ergonómicamente diseñada para que el agua y el polvo resbalen por el rail / Construction will guide rain and dust away / Ergonomiquement conçu pour que l'eau et la poussière glisse sur le rebord	●



COD.	L x W x H (mm)	
<b>50995</b>	464 x 335 x 212	2,5

**ESPECIFICACIONES TÉCNICAS / TECHNICAL SPECIFICATION / DÉTAILS TECHNIQUES**

Capacidad / Capacity / Capacité	60 kg
ABS extra resistente / Extra-resistant ABS / ABS extra-résistant	Hasta 90 kg / Up to 90 kg / Jusqu'à 90 kg
Apilables / Stackables / Empilables	●
Auto-basculante / Self-balancing / Auto-basculant	●
Ergonómicamente diseñada para que el agua y el polvo resbalen por el rail / Construction will guide rain and dust away / Ergonomiquement conçu pour que l'eau et la poussière glisse sur le rebord	●



COD.	L x W x H (mm)	
<b>50996</b>	464 x 335 x 362	3,2

**ESPECIFICACIONES TÉCNICAS / TECHNICAL SPECIFICATION / DÉTAILS TECHNIQUES**

Capacidad / Capacity / Capacité	60 kg
ABS extra resistente / Extra-resistant ABS / ABS extra-résistant	Hasta 90 kg / Up to 90 kg / Jusqu'à 90 kg
Apilables / Stackables / Empilables	●
Auto-basculante / Self-balancing / Auto-basculant	●
Ergonómicamente diseñada para que el agua y el polvo resbalen por el rail / Construction will guide rain and dust away / Ergonomiquement conçu pour que l'eau et la poussière glisse sur le rebord	●





**ACCESORIOS / ACCESSORIES / ACCESSOIRES / ERSATZTEILE / ACCESSORI / ACESSORIOS / ЗАПАСНЫЕ ЧАСТИ**

COD.	Descripción / Description / Description
<b>50981</b>	Panel superior fijo / Fixed upper panel / Panneau supérieur fixe
<b>50982</b>	Panel inferior móvil / Movable lower panel / Panneau inférieur amovible





**MALETA ABS APILABLE Y CASI INDESTRUCTIBLE CON PANELES / ABS TOOL CASE STACKABLE AND ALMOST INDESTRUCTIBLE WITH PANELS / VALISE ABS EMPILABLE ET PRESQUE INDESTRUCTIBLE AVEC PANNEAUX / ABS-WERKZEUGKASTE STAPELBAR UND MIT PANELEN FAST UNZERSTÖRBAR / VALIGIA IN ABS IMPILABILE E QUASI INDISTRUTTIBILE CON PANNELLI / MALA ABS EMPILHÁVEL E QUASE INDESTRUTÍVEL COM PAINÉIS / СВЕРХПРОЧНЫЙ ШТАБЕЛИРУЕМЫЙ ЯЩИК АБС С ПАНЕЛЯМИ**

COD.	L x W x H (mm)		
<b>50983</b>	464 x 335 x 142	1	2,55

**ESPECIFICACIONES TÉCNICAS / TECHNICAL SPECIFICATION / DÉTAILS TECHNIQUES**

Capacidad / Capacity / Capacité	60 kg
ABS extra resistente / Extra-resistant ABS / ABS extra-résistant	Hasta 90 kg / Up to 90 kg / Jusqu'à 90 kg
Panel / Panel / Panneau	Superior: cod. 50981   Inferior: cod. 50982 / Upper: cod. 50981   Lower: cod. 50982 / Supérieur: cod. 50981   Inférieur: cod. 50982
Apilables / Stackables / Empilables	●
Auto-basculante / Self-balancing / Auto-basculant	●
Ergonómicamente diseñada para que el agua y el polvo resbalen por el rail / Construction will guide rain and dust away / Ergonomiquement conçu pour que l'eau et la poussière glisse sur le rebord	●





COD.	L x W x H (mm)		
<b>50984</b>	464 x 335 x 212	1	3,05

**ESPECIFICACIONES TÉCNICAS / TECHNICAL SPECIFICATION / DÉTAILS TECHNIQUES**

Capacidad / Capacity / Capacité	60 kg
ABS extra resistente / Extra-resistant ABS / ABS extra-résistant	Hasta 90 kg / Up to 90 kg / Jusqu'à 90 kg
Panel / Panel / Panneau	Superior: cod. 50981   Inferior: cod. 50982 / Upper: cod. 50981   Lower: cod. 50982 / Supérieur: cod. 50981   Inférieur: cod. 50982
Apilables / Stackables / Empilables	●
Auto-basculante / Self-balancing / Auto-basculant	●
Ergonómicamente diseñada para que el agua y el polvo resbalen por el rail / Construction will guide rain and dust away / Ergonomiquement conçu pour que l'eau et la poussière glisse sur le rebord	●



COD.	L x W x H (mm)			
<b>50985</b>	464 x 335 x 362	1	2	5,05

**CARACTERÍSTICAS / FEATURES / CARACTÉRISTIQUES**

Posibilidad de incorporar más paneles en el fondo / Possibility to place more panels on the bottom / Possibilité d'incorporer plus de panneaux au fond

**ESPECIFICACIONES TÉCNICAS / TECHNICAL SPECIFICATION / DÉTAILS TECHNIQUES**

Capacidad / Capacity / Capacité	60 kg
ABS extra resistente / Extra-resistant ABS / ABS extra-résistant	Hasta 90 kg / Up to 90 kg / Jusqu'à 90 kg
Panel / Panel / Panneau	Superior: cod. 50981   Inferior: cod. 50982 / Upper: cod. 50981   Lower: cod. 50982 / Supérieur: cod. 50981   Inférieur: cod. 50982
Apilables / Stackables / Empilables	●
Auto-basculante / Self-balancing / Auto-basculant	●
Ergonómicamente diseñada para que el agua y el polvo resbalen por el rail / Construction will guide rain and dust away / Ergonomiquement conçu pour que l'eau et la poussière glisse sur le rebord	●



**CARRO DE TRANSPORTE PARA MALETAS ABS APILABLES / TROLLEY FOR ABS STACKABLE TOOL CASES / CHARIOT POUR TRANSPORT DE VALISES ABS EMPILABLES / WAGEN FÜR STAPELBARE WERKZEUGKOFFER / CARRELLO PER TRASPORTO DI VALIGIE ABS IMPILABILI / CARRO DE TRANSPORTE PARA MALAS ABS EMPILHÁVEIS / ТЕЛЕЖКА ДЛЯ ПЛАСТИКОВЫХ ИНСТРУМЕНТАЛЬНЫХ ЯЩИКОВ**

**SIN MANGO / WITHOUT HANDLE / SANS MANCHE / OHNE GRIFF / SENZA MANICO / SEM CABO / БЕЗ РУКОЯТКИ**

COD.	L x W x H (mm)	Kg
<b>50988</b>	470 x 350 x 110	3,5

**ESPECIFICACIONES TÉCNICAS / TECHNICAL SPECIFICATION / DÉTAILS TECHNIQUES**

2 ruedas giratorias y 2 giratorias con freno / 2 revolving and 2 revolving with break wheels / 2 roues giratoires et 2 giratoires avec frein	●
Capacidad / Capacity / Capacité	200 kg



**CON MANGO / WITH HANDLE / AVEC MANCHE / MIT GRIFF / CON MANICO / COM CABO / С РУКОЯТКОЙ**

COD.	L x W x H (mm)	Kg
<b>50964</b>	430 X 560 X 910	8,8

**ESPECIFICACIONES TÉCNICAS / TECHNICAL SPECIFICATION / DÉTAILS TECHNIQUES**

Capacidad / Capacity / Capacité	200 kg
---------------------------------	--------



**MALETA APILABLE / STACKABLE TOOL CASE / VALISE EMPILABLE / STAPELBARER WERKZEUGKOFFER / CASSETTO PORTAUTENSILI IMPILABILE / MALA EMPILHÁVEL / ШТАБЕЛИРУЕМЫЙ КЕЙС**

**585 x 385 x 190**

COD.	L x W x H (mm)	Kg
<b>58870</b>	585 x 385 x 190	5,0

**ESPECIFICACIONES TÉCNICAS / TECHNICAL SPECIFICATION / DÉTAILS TECHNIQUES**

Apilables / Stackables / Empilables	●
Mat: PP	●
Capacidad / Capacity / Capacité	12 L



## 585 x 385 x 320

COD.	L x W x H (mm)	Kg
<b>58871</b>	585 x 385 x 320	5,5

## ESPECIFICACIONES TÉCNICAS / TECHNICAL SPECIFICATION / DÉTAILS TECHNIQUES

Apilables / Stackables / Empilables	●
Mat: PP	●
Capacidad / Capacity / Capacité	38 L



## 585 x 385 x 420

COD.	L x W x H (mm)	Kg
<b>58872</b>	585 x 385 x 420	6,5

## ESPECIFICACIONES TÉCNICAS / TECHNICAL SPECIFICATION / DÉTAILS TECHNIQUES

Apilables / Stackables / Empilables	●
Mat: PP	●
Capacidad / Capacity / Capacité	52 L

**PLATAFORMA PARA MALETAS APILABLES / PLATFORM FOR STACKABLE CASES / PLATEFORME POUR MALETTES EMPILABLES / PLATTFORM FÜR STAPELBARE KOFFER / PIATTAFORMA PER CASSETTE PORTAUNTENSILI IMPILABILI / PLATAFORMA PARA MALAS MODULARES / ПЛАТФОРМА ДЛЯ ШТАБЕЛИРУЕМЫХ кейсов**

COD.	L x W x H (mm)	Kg
<b>58873</b>	745 x 510 x 180	4,5

## ESPECIFICACIONES TÉCNICAS / TECHNICAL SPECIFICATION / DÉTAILS TECHNIQUES

Apilables / Stackables / Empilables	●
Mat: PP	●
2 ruedas fijas y 2 giratorias con freno / 2 fixed and 2 revolving with brake wheels / 2 roues fixes et 2 roues giratoires avec frein	●

**JUEGO DE MALETAS APILABLES CON PLATAFORMA / STOCKABLE CASE SET WITH PLATFORM / JEU DE MALETTES EMPILABLES AVEC PLATEFORME / STAPELBARE KOFFER MIT PLATTFORM / KIT CASSETTE PORTAUNTENSILI IMPILABILI CON PIATTAFORMA / CONJUNTO DE MALAS MODULARES COM PLATAFORMA / КОМПЛЕКТ кейсов НА ПЛАТФОРМЕ**

COD.	L x W x H (mm)	Kg
<b>58874</b>	745 x 510 x 1000	22

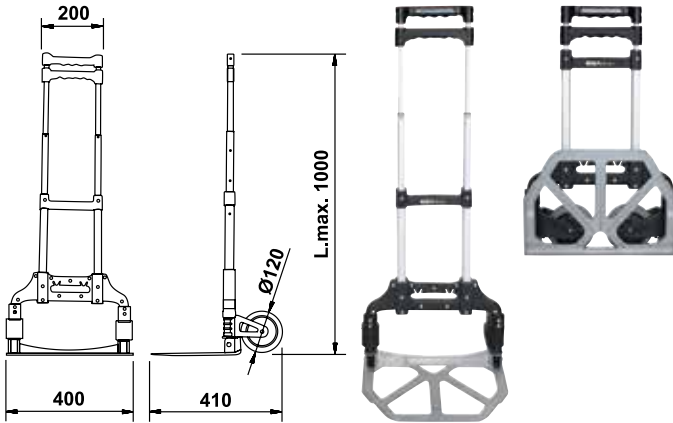

**CARRO DE TRANSPORTE UNIVERSAL / UNIVERSAL TROLLEY / CHARIOT POUR TRANSPORT UNIVERSEL / UNIVERSALWAGEN / CARRELLO PER TRASPORTO UNIVERSALE / CARRO DE TRANSPORTE MANUAL / УНИВЕРСАЛЬНАЯ ТЕЛЕЖКА**







COD.	L x W x H (mm)		
<b>50986</b>	1000 x 400 x 410	630 x 390 x 60	3,15

**ESPECIFICACIONES TÉCNICAS / TECHNICAL SPECIFICATION / DÉTAILS TECHNIQUES**

2 ruedas / 2 wheels / 2 roues	●
Capacidad / Capacity / Capacité	60 kg
Material / Material / Matière	Aluminio / Aluminum / Aluminium
Cuerda para amarre / Mooring rope / Corde pour amarrage	●





**CAJAS DE HERRAMIENTAS / TOOL BOXES / CAISSES À OUTILS / WERKZEUGKASTEN / CASSETTE PORTAUTENSILI / CAIXAS DE FERRAMENTAS / ЯЩИКИ ДЛЯ ИНСТРУМЕНТА**



Disponible en 4 colores  
 Available in 4 colors  
 Disponible en 4 couleurs

COD.	L x W x H (mm)		Color / Colour / Couleur
<b>51023</b>	495 x 200 x 293	4,5	
<b>51482</b>			
<b>51494</b>			
<b>51506</b>			

**ESPECIFICACIONES TÉCNICAS / TECHNICAL SPECIFICATION / DÉTAILS TECHNIQUES**

Capacidad / Capacity / Capacité	25 kg
Elementos / Compartments / Cases	5

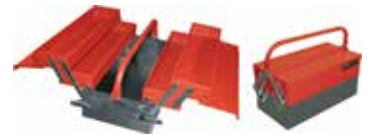
COD.	L x W x H (mm)		Color / Colour / Couleur
<b>51038</b>	404 x 200 x 195	3,3	
<b>51485</b>			
<b>51497</b>			
<b>51509</b>			



**ESPECIFICACIONES TÉCNICAS / TECHNICAL SPECIFICATION / DÉTAILS TECHNIQUES**

Capacidad / Capacity / Capacité	20 kg
Elementos / Compartments / Cases	5

COD.	L x W x H (mm)	
<b>64648</b>	550 x 245 x 250	4,0

**ESPECIFICACIONES TÉCNICAS / TECHNICAL SPECIFICATION / DÉTAILS TECHNIQUES**

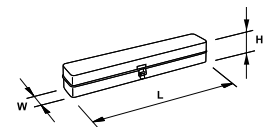
Capacidad / Capacity / Capacité	20 kg
Elementos / Compartments / Cases	1



COD.	L x W x H (mm)	
<b>86280</b>	305 x 50 x 45	0,25
<b>86281</b>	315 x 80 x 40	0,30
<b>86282</b>	410 x 75 x 65	0,56
<b>86283</b>	370 x 100 x 60	0,75
<b>86284</b>	280 x 130 x 75	1,00
<b>86285</b>	540 x 95 x 75	1,25
<b>86286</b>	305 x 45 x 40	0,20
<b>86287</b>	310 x 85 x 40	0,30
<b>86288</b>	380 x 65 x 60	0,65
<b>86289</b>	380 x 100 x 60	0,75
<b>86290</b>	280 x 130 x 75	1,00
<b>86291</b>	540 x 95 x 75	1,25

COD.	L x W x H (mm)	CAP. (kg)	
<b>51058</b>	400 x 206 x 188	15	955

**ESPECIFICACIONES TÉCNICAS / TECHNICAL SPECIFICATION / DÉTAILS TECHNIQUES**

Mat: PP	●
Compartimentos / Compartments / Cases	8
1 bandeja / 1 tray / 1 plateau	●





COD.	L x W x H (mm)	CAP. (kg)	Kg
<b>51059</b>	480 x 258 x 255	30	2,22

ESPECIFICACIONES TÉCNICAS / TECHNICAL SPECIFICATION / DÉTAILS TECHNIQUES	
Estuche / Case / Étui	1
Mat: PP	●
Compartimentos / Compartments / Cases	8, 16
1 bandeja / 1 tray / 1 plateau	●



#### ■ CANDADOS / PADLOCKS / UN CADENAS / VORHÄNGESCHLOSSE / LUCCHETTI / CADEADOS / ЗАМКИ

COD.	L (mm)	O.D. mm	g
<b>11130</b>	32	4,2	28
<b>11131</b>	42	4,6	46



#### ■ BOLSAS, MOCHILAS Y CHALECOS / BAGS, POUCHES BACKPACKS AND VESTS / SACS À DOS ET GILLETS / TASCHEN, RÜCKSACK UND VESTS / BORSE, ZAINI E GILET / BOLSAS, MOCHILAS E COLETES / СУМКИ, РЮКЗАКИ И ЖИЛЕТЫ

#### ■ BOLSAS PORTAHERRAMIENTAS / TOOL BAGS / SACS PORTE-OUTILS / WERKZEUGTASCHE / BORSA PORTAUTENSILI / BOLSA PORTA FERRAMENTAS / ИНСТРУМЕНТАЛЬНЫЕ СУМКИ

COD.	L x W x H (mm)	Kg-MAX	50	●
<b>51014</b>	495 x 265 x 340	20	50	●



COD.	L x W x H (mm)	Kg-MAX	32	●
<b>51034</b>	400 x 265 x 295	15	32	●



COD.	L x W x H (mm)	Kg-MAX	22	●
<b>51013</b>	400 x 215 x 305	15	22	●



COD.	L x W x H (mm)	Kg-MAX	16	●
<b>51033</b>	400 x 230 x 295	15	16	●



COD.	L x W x H (mm)	Kg-MAX		
<b>50960</b>	415 x 230 x 260	15	15	●



COD.	L x W x H (mm)	Kg-MAX		
<b>50961</b>	495 x 245 x 290	15	36	●



COD.	L x W x H (mm)	Kg-MAX		
<b>50962</b>	510 x 290 x 360	15	4	●



#### MOCHILA PORTAHERRAMIENTA / TOOL BACKPACK / SAC À DOS PORTE-OUTILS / WERKZEUG RUCKSACK / ZAINO PORTA UTENSILI / MOCHILA PORTA-FERRAMENTA / РЮКЗАК ДЛЯ ИНСТРУМЕНТОВ

COD.	L x W x H (mm)	Kg-MAX		Kg
<b>50963</b>	390 x 220 x 480	20	66	2,1

#### ESPECIFICACIONES TÉCNICAS / TECHNICAL SPECIFICATION / DÉTAILS TECHNIQUES

Correas acolchadas ajustables / <i>Adjustable padded straps</i> / Bretelles matelassées ajustables	●
Cintas para la fijación de objetos / <i>Strap to tie objects</i> / Sangle pour fixation des objets	●
Bolsillos laterales / <i>Side compartments</i> / Poches latérales	2
Bolsillo interior en la parte delantera / <i>Internal pocket at the front of the pack</i> / Poche intérieure sur la partie avant	1
Bolsillos interiores / <i>Internal pockets</i> / Poches intérieures	63



**BOLSA PARA SETS DE LLAVES FIJAS / BAG FOR OPEN-END WRENCH SETS / TROUSSE POUR SET DE CLÉS À FOURCHES / TASCHE F-MAULSCHLÜSSEL / BORSA PER SET DI CHIAVI FISSE / BOLSA PARA CONJUNTO DE CHAVES DE BOCA / СУМКА ДЛЯ НАБОРА РОЖКОВЫХ КЛЮЧЕЙ**

COD.	L x W (mm)	PCS.
<b>90052</b>	290 x 250	6
<b>90053</b>	425 x 295	8
<b>90054</b>	510 x 330	10
<b>90055</b>	700 x 370	12

**BOLSA PARA SETS DE LLAVES COMBINADAS / BAG FOR COMBINATION WRENCH SETS / TROUSSE POUR SET DE CLÉS MIXTES / TASCHE F-RINGMAULSCHLÜSSEL / BORSA PER SET DI CHIAVI COMBINATE / BOLSA PARA CONJUNTO DE CHAVES COMBINADAS / СУМКА ДЛЯ НАБОРА КОМБИНИРОВАННЫХ КЛЮЧЕЙ**

COD.	L x W (mm)	PCS.
<b>90080</b>	245 x 280	6
<b>90081</b>	315 x 300	8
<b>90082</b>	435 x 300	10
<b>90083</b>	505 x 360	12
<b>90060</b>	660 x 490	13
<b>90063</b>	775 x 490	14
<b>90061</b>	710 x 490	15
<b>90064</b>	770 x 440	17
<b>90065</b>	740 x 580	26

**BOLSA PARA SETS DE LLAVES ACODADAS / BAG FOR DOUBLE OFFSET RING WRENCH SETS / TROUSSE POUR SET DE CLÉS POLYGONALES CONTRE-COUDÉES / TASCHE F-RINGSCHLÜSSEL / BORSA PER SET DI CHIAVI POLIGONALI / BOLSA PARA CONJUNTO DE CHAVES DE LUNETA / СУМКА ДЛЯ НАБОРА НАКИДНЫХ КЛЮЧЕЙ**

COD.	L x W (mm)	PCS.
<b>90056</b>	325 x 325	6
<b>90057</b>	500 x 370	8
<b>90058</b>	615 x 440	10
<b>90059</b>	755 x 495	12



**CHALECO PORTAHERRAMIENTAS / TOOL VEST / VESTE PORTE - OUTILS / WERKZEUGWESTE / GILET PORTAUTENSILI / COLETE PORTA FERRAMENTAS / ЖИЛЕТ ДЛЯ НОШЕНИЯ ИНСТРУМЕНТА**

COD.	L x W (mm)
51015	510 x 600



**CINTURÓN PORTAHERRAMIENTAS / TOOL BELT / CEINTURE PORTE - OUTILS / WERKZEUGGÜRTEL / CINTURA PORTAUTENSILI / CINTURAO PORTA FERRAMENTAS / ИНСТРУМЕНТАЛЬНЫЙ ПОЯС**

COD.	L (inch)	Kg-MAX
51009	32-44	15



**ESPECIFICACIONES TÉCNICAS / TECHNICAL SPECIFICATION / DÉTAILS TECHNIQUES**

Bolsillos laterales / Side compartments / Poches latérales	21
--	----

**BOLSA 14 BOLSILLOS / 14 POCKETS NYLON BAG / TROUSSE 14 POCHEs / NYON TASCHE MIT 14 FÄCHER / BORSA CON 14 TASCHE / BOLSA 14 BOLSOS / НЕЙЛОНОВАЯ СУМКА (14 ОТДЕЛЕНИЙ)**

COD.		
50930	14	275

**BOLSA 7 BOLSILLOS / 7 POCKETS NYLON BAG / TROUSSE 7 POCHEs / NYLON TASCHE MIT 7 FÄCHER / BORSA CON 7 TASCHE / BOLSA 7 BOLSOS / НЕЙЛОНОВАЯ СУМКА (7 ОТДЕЛЕНИЙ)**

COD.		
50931	7	245



**BOLSA 6 BOLSILLOS / 6 POCKETS NYLON BAG / TROUSSE 6 POCHEs / NYLON TASCHE MIT 6 FÄCHER / BORSA CON 6 TASCHE / BOLSA 6 BOLSOS / НЕЙЛОНОВАЯ СУМКА (6 ОТДЕЛЕНИЙ)**

COD.		
90162	6	115

**ACCESORIO PARA MARTILLO / ACCESSORY FOR HAMMER / ACCESSOIRE POUR MARTEAU / ZUBEHÖR F/HAMMER / ACCESSORIO PER MARTELLO / ACESSÓRIO PARA MARTELO / ПОЯСНОЙ КАРМАН ДЛЯ МОЛОТКА**

COD.	
50932	92

**CINTO / BELT / CEINTURE / RIEM / CINTURONE / CINTO / ПОЯС**

COD.	L (mm)	
50933	135	260





# PROYECTOS PRINCIPALES

## MAIN PROJECTS

### PRINCIPAUX PROJETS



**AERO CONTRACTORS**

**AERONÁUTICA / AEROSPACE / AÉRONAUTIQUE**

**NIGERIA**

