

8

LLAVES
WRENCHES
CLÉS
SCHLÜSSEL
CHIAVI
CHAVES
КЛЮЧИ



LLAVE COMBINADA REVERSIBLE MASTERGEAR REVERSIBLE MASTERGEAR COMBINATION WRENCH CLÉS MIXTES REVERSIBLES MASTERGEAR

El diseño exclusivo de las llaves **MASTERGEAR** provee al profesional más exigente de una llave multiuso para el apriete en los lugares de más difícil acceso y con un cómodo sistema de carraca. Fabricadas en cromo-vanadio, soportan ampliamente los valores de torsión de los estándares de calidad más exigentes. Su carraca de 72 dientes junto con el diseño especial de su cabeza posibilita aprietes en las posiciones más complicadas, necesitando únicamente 5° para ello. Reversibles, Stubby, E-Torx... todo lo necesario para el profesional.

The exclusive design of the MASTERGEAR wrenches, provides the demanding professional with an all-in-one wrench for the most difficult access tightening, with a comfortable ratchet system. Made in chrome vanadium, they easily stand the most restrictive quality standards for torque. Their 72 teeth gear together with the ratchet head design enables tightening in the narrowest places, with only 5° required for such purpose. Reversible, Stubby, E-Torx... all that the demanding professional may need.

La conception exclusive de la clé **MASTERGEAR** fournit au professionnel le plus exigeant une clé multi-usages pour le serrage dans des lieux exigus, avec un système de cliquet. Fabriquées en chrome vanadium, elles supportent amplement les valeurs de torsion que requièrent les standards de qualité les plus exigeants. Son cliquet de 72 dents, combiné à un dessin spécifique de la tête, permet des serrages dans les positions les plus complexes, requerrant uniquement 5° pour agir. Réversibles, Stubby, E-Torx... tout l'indispensable pour le professionnel.

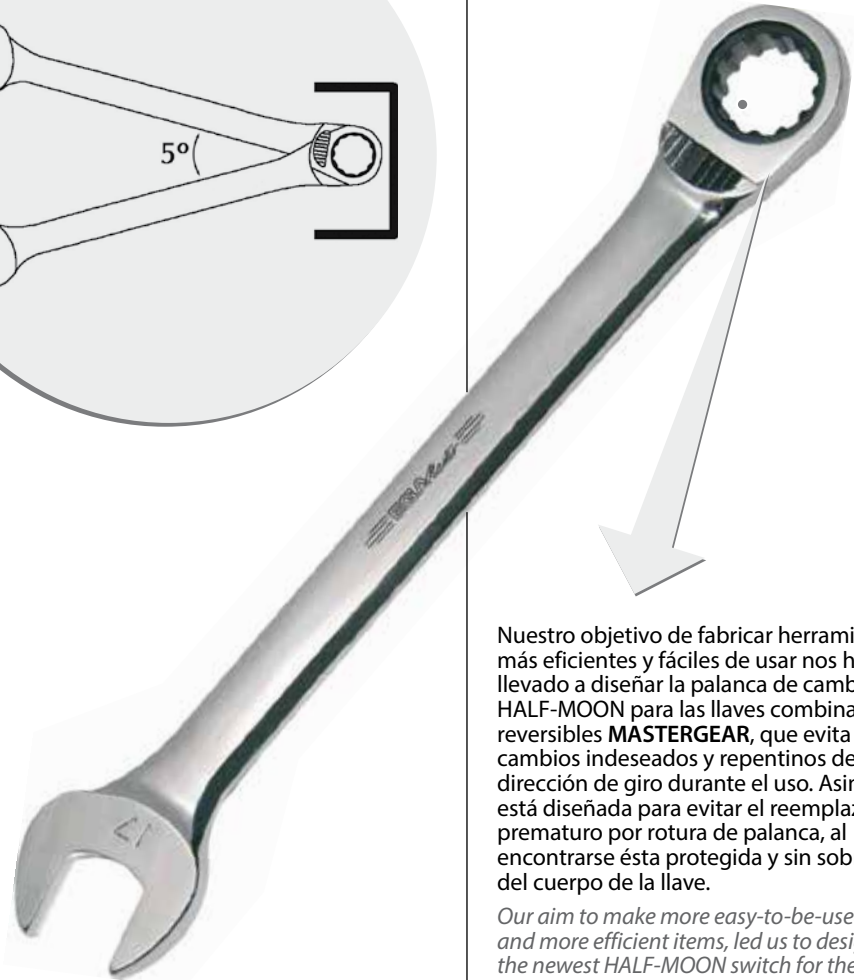
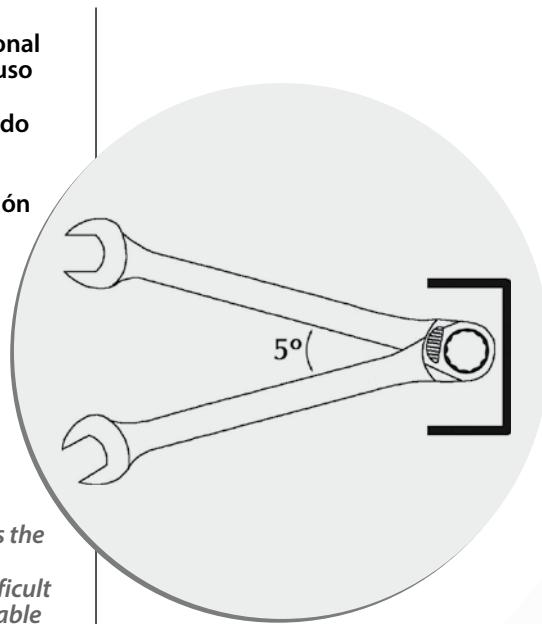

Nuestro objetivo de fabricar herramientas más eficientes y fáciles de usar nos ha llevado a diseñar la palanca de cambio HALF-MOON para las llaves combinadas reversibles **MASTERGEAR**, que evita cambios indeseados y repentinos de dirección de giro durante el uso. Asimismo, está diseñada para evitar el reemplazo prematuro por rotura de palanca, al encontrarse ésta protegida y sin sobresalir del cuerpo de la llave.

Our aim to make more easy-to-be-used and more efficient items, led us to design the newest HALF-MOON switch for the MASTERGEAR Reversible Combination Wrenches, which avoids unwanted or unconscious switch reversing as well as premature damage of the switch. Besides, this switch is designed to avoid the early need to replace it because of breakage, as this switch is protected by the body of the wrench.

Notre objectif de fabriquer des outils plus performants et plus faciles d'usage, nous a amené à dessiner le bouton de changement de sens de la clé à cliquet réversible **MASTERGEAR**, en forme de demi-lune, ce qui a pour effet d'éviter des changements de sens indésirables et soudain durant l'utilisation. De même, sa conception permet d'éviter des remplacements prématurés de la clé pour cause de rupture du levier, le bouton étant protégé car ne ressortant pas trop du corps de l'outil.

Su innovador diseño de estrella permite apretar múltiples y diferentes cabezas de tornillo, tales como Spline, 6 lados, 12 lados, E-torx y Cuadrados, incluso en cabezas redondeadas hasta en un 50% por el desgaste.

Its innovative box drive allows to tighten multiple nut heads such as Spline, 6-point, 12 point, Square and E-torx, as well as with 50% rounded off nuts.

Son dessin innovateur en étoile, permet de serrer de multiples et différentes têtes de vissage, telles que Spline, 6 pans, 12 pans, E-Torx et carrées, y compris des têtes arrondies à 50% par usure.

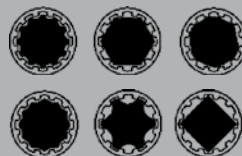

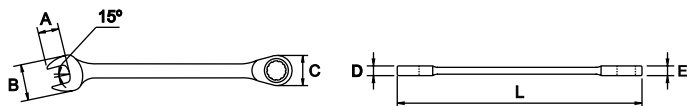
MASTERGEAR
LLAVE COMBINADA DE CARRACA MASTERGEAR / MASTERGEAR COMBINATION RATCHET WRENCH / CLÉ MIXTE À CLIQUET MASTERGEAR / RATSCHEN-RINGGABELSCHLÜSSEL / CHIAVE COMBINATA A CRICCO MASTERGEAR / CHAVE DE BOCA E LUNETA COM ROQUETE MASTERGEAR / КЛЮЧ ТРЕЩЕТОЧНЫЙ КОМБИНИРОВАННЫЙ MASTERGEAR
MM

COD.	AP mm	L (mm)	A (mm)	B (mm)	C (mm)	D (mm)	E (mm)	g		
62622	6	125	7	13,5	14,5	4,2	6,5	45		
62650	7	130	8	14,5	17,5	4,3	6,8	50		
62651	8	145	9,5	17	18	4,7	7,4	55		
62652	9	150	10	18	19	5,3		60		
62653	10	160	11	22	21	5,7		80		
62654	11	165	12	23	22	6,1		90		
62655	12	175	13	25	23	6,4	8,4	100	10	
62656	13	180	15	26	25	6,6		120		
62657	14	190	16	29	26	7,3		130		
62658	15	200	17	31	28	7,5		150		
62659	16	210	18	33	29	7,7	10,0	180		• A
62660	17	230	20	36	30	7,9		200		
62661	18	240		38	32	8,4	11,5	240		
62662	19	250		39	34	8,7		310		
62663	21	270	24	43	38	9,5	12,5	340		
62664	22	280	25	46	41	10,0	13,5	450		
62665	24	300	26	48	45	11,0		600	5	
62677	27	340	31	55	48	13,0	14,5	800		
62678	30	370	35	62	55	14,0	17,0	950		
62679	32	400	37	64	60	15,0				

DIN 1711 | Modelo registrado / Registered model / Modèle enregistré
CARACTERÍSTICAS / FEATURES / CARACTÉRISTIQUES

Cr-V

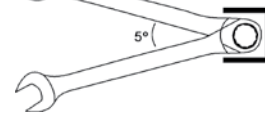
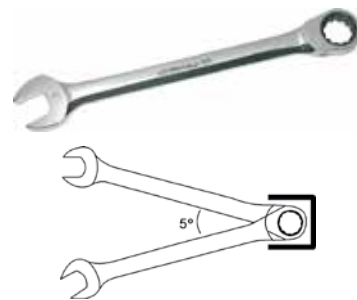
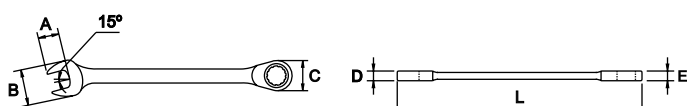
INCH

COD.	AP inch	L (mm)	A (mm)	B (mm)	C (mm)	D (mm)	E (mm)	g		
62666	5/16	145	9,0	17	18	4,7	7,4	50		
62667	3/8	160	12	22	21	5,7		60		
62668	7/16	165		23	22	6,1	8,4	80		
62669	1/2	180	14	26	25	6,6		100		
62670	9/16	190	16	29	26	7,3		120	10	
62671	5/8	210	18	33	29	7,7	10,0	150		
62672	11/16	230	20	36	30	7,9		180		• A
62673	3/4	250	22	39	34	8,7	11,5	240		
62674	13/16	270	23	43	38	9,5	12,5	310		
62675	7/8	280	26	46	41	10,0	13,5	340		
62676	15/16	300	27	48	45	11,0		450	5	
62709	1	320	26	51	45,7	9,4	14,5	480		



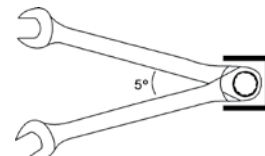

DIN 1711 | Modelo registrado / Registered model / Modèle enregistré
CARACTERÍSTICAS / FEATURES / CARACTÉRISTIQUES

Cr-V

A Cromado pulido espejo / Mirror polished chrome plating / Polie chromée / Verchromt geschliffen / Cromate lucide / Cromado pulido / Полированный хром



■ SET

■ MM

COD.		PCS.	
69864	A	10	1000
Composición / Composition / Composition			
62651, 62653, 62655, 62656, 62660, 62662		8-10-12-13-17-19 mm	
62772, 62773, 62774		1/4-10, 3/8-17, 1/2-19 mm	
62775		1/4"-1/4"	







■ MM

COD.		PCS.	
69865	A	6	800
Composición / Composition / Composition			
62651, 62653, 62655, 62656, 62660, 62662		8-10-12-13-17-19 mm	





■ MM

COD.		PCS.	
69868	A	16	2000
Composición / Composition / Composition			
62651, 62652, 62653, 62654, 62655, 62656, 62657, 62658, 62659, 62660, 62661, 62662		8-9-10-11-12-13-14-15-16-17-18-19 mm	
62772, 62773, 62774		1/4-10, 3/8-17, 1/2-19 mm	
62775		1/4"-1/4"	







■ MM

COD.		PCS.	
69869	A	12	1800
Composición / Composition / Composition			
62651, 62652, 62653, 62654, 62655, 62656, 62657, 62658, 62659, 62660, 62661, 62662		8-9-10-11-12-13-14-15-16-17-18-19 mm	



■ INCH

COD.		PCS.	
51453	A	10	1000
Composición / Composition / Composition			
62666, 62667, 62668, 62669, 62672, 62673		5/16"- 3/8"- 7/16"- 1/2"- 11/16"- 3/4"	
62772, 62773, 62774		1/4-10, 3/8-17, 1/2-19 mm	
62775		1/4"-1/4"	



INCH

COD.		PCS.	
51454	A	6	800
Composición / Composition / Composition			
62666, 62667, 62668, 62669, 62672, 62673		5/16"-3/8"-7/16"-1/2"-11/16"-3/4"	



SET DEMO-BLOCK

COD.	 mm		
64502	13	*****	300





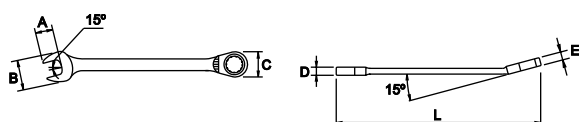

MASTERGEAR REV.

LLAVE COMBINADA DE CARRACA REVERSIBLE MASTERGEAR / REVERSIBLE MASTERGEAR COMBINATION RATCHET WRENCH / CLÉ MIXTE A CLIQUET RÉVERSIBLE MASTERGEAR / UMKEHRBARE RATSCHEN-GABELSCHLÜSSEL / CHIAVE COMBINATA A CRICCO REVERSIBILE MASTERGEAR / CHAVE DE BOCA E LUNETEA DE ROQUETE REVERSIVEL MASTERGEAR / КЛЮЧ РЕВЕРСИВНЫЙ ТРЕЩЕТОЧНЫЙ КОМБИНИРОВАННЫЙ MASTERGEAR

MM



COD.	 mm	L (mm)	A (mm)	B (mm)	C (mm)	D (mm)	E (mm)			
62680	8	145	9,5	17	18	4,7	7,4	50		
62681	9	150	10	19	19	5,3		55		
62682	10	160	11	22	21	5,7		60		
62683	11	165	12	23	22	6,1		80		
62684	12	175	13	25	23	6,4		90		
62685	13	180	15	26	25	6,6	8,4	100		
62686	14	190	16	29	26	7,3		120	10	
62687	15	200	17	31	28	7,5		130		● A
62688	16	210	18	33	29	7,7		150		
62689	17	230	20	36	30	7,9	10,0	180		
62690	18	240		38	32	8,4		200		
62691	19	250	21	39	34	8,7	11,5	240		
62692	21	270	24	43	38	9,5	12,5	310		
62693	22	280	25	46	41	10,0		340	5	
62694	24	300	26	48	45	11,0	13,5	450		

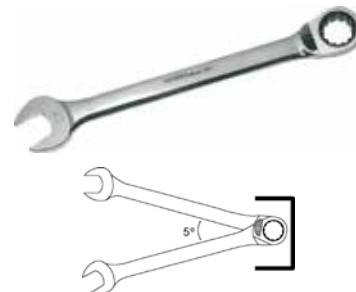

DIN 1711 | Modelo registrado / Registered model / Modèle enregistré

CARACTERÍSTICAS / FEATURES / CARACTÉRISTIQUES

Cr-V

Reversible / Reversible / Réversible

INCH

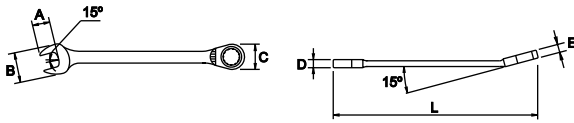

COD.	AP inch	L (mm)	A (mm)	B (mm)	C (mm)	D (mm)	E (mm)	g	10	5
62695	5/16	145	9,0	17	18	4,7	7,4	50		
62696	3/8	160		22	21	5,7		60		
62697	7/16	165	12	23	22	6,1		80		
62698	1/2	180	14	26	25	6,6		100		
62699	9/16	190	16	29	26	7,3		120	10	
62700	5/8	210	18	33	29	7,7		150		
62701	11/16	230	20	36	30	7,9	10,0	180		• A
62702	3/4	250	22	39	34	8,7	11,5	240		
62703	13/16	270	23	43	38	9,5	12,5	310		
62704	7/8	280	26	46	41	10,0		340		5
62705	15/16	300	27	48	45	11,0	13,5	450		

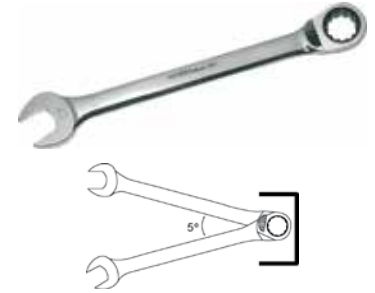

DIN 1711 | Modelo registrado / Registered model / Modèle enregistré

CARACTERÍSTICAS / FEATURES / CARACTÉRISTIQUES

Cr-V

Reversible / Reversible / Réversible

SET

MM

COD.	PCS.	g	
69866	A	10	1000
Composición / Composition / Composition			
62680, 62682, 62684, 62685, 62689, 62691	8-10-12-13-17-19 mm		
62772, 62773, 62774	1/4-10, 3/8-17, 1/2-19 mm		
62775	1/4"-1/4"		



MM

COD.	PCS.	g	
69867	A	6	800
Composición / Composition / Composition			
62680, 62682, 62684, 62685, 62689, 62691	8-10-12-13-17-19 mm		





MM

COD.	PCS.	g	
69870	A	16	2000
Composición / Composition / Composition			
62680, 62681, 62682, 62683, 62684, 62685, 62686, 62687, 62688, 62689, 62690, 62691	8-9-10-11-12-13-14-15-16-17-18-19 mm		
62772, 62773, 62774	1/4-10, 3/8-17, 1/2-19 mm		
62775	1/4"-1/4"		







A Cromado pulido espejo / Mirror polished chrome plating / Polie chromée / Verchromt geschliffen / Cromate lucide / Cromado pulido / Полированный хром

MM

COD.		PCS.	
69871	A	12	1800
Composición / Composition / Composition			
62680, 62681, 62682, 62683, 62684, 62685, 62686, 62687, 62688, 62689, 62690, 62691		8-9-10-11-12-13-14-15-16-17-18-19 mm	





INCH

COD.		PCS.	
51455	A	10	1000
Composición / Composition / Composition			
62695, 62696, 62697, 62698, 62701, 62702		5/16"-3/8"-7/16"-1/2"-11/16"-3/4"	
62772, 62773, 62774		1/4"-10, 3/8"-17, 1/2"-19 mm	
62775		1/4"-1/4"	







INCH

COD.		PCS.	
51456	A	6	800
Composición / Composition / Composition			
62695, 62696, 62697, 62698, 62701, 62702		5/16"-3/8"-7/16"-1/2"-11/16"-3/4"	

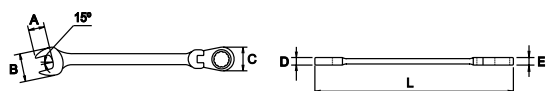
MASTERGEAR ARTICULADA / MASTERGEAR JOINT / MASTERGEAR ARTICULÉE / RATSCHEN-RINGGABELSCHLÜSSEL MIT VERSTELLBAREM KOPF / MASTERGEAR SNOODATA / MASTERGEAR ARTICULADA / MASTERGEAR ШАРНИР

MM



COD.		L (mm)	A (mm)	B (mm)	C (mm)	D (mm)	E (mm)			
61379	6	125	6,8	13,5	14,4	4,2	6,5	50		
61404	7	132	7,9	14,6	17,5	4,3	6,8	55		
61530	8	145	9,5	17	18	4,7	7,4	60		
61531	9	150	10	19	19	5,3		65		
61532	10	155	11	22	21	5,7		70		
61533	11	165	12	23	22	6,1		90		
61534	12	170	13	25	23	6,4		95		
61535	13	180	15	26	25	6,6	8,4	110	10	
61536	14	190	16	29	26	7,3		120		
61537	15	200	17	31	28	7,5		140		
61538	16	210	18	33	29	7,7	10,0	160		
61539	17	230	20	36	30	7,9		190		
61540	18	240		38	32	8,4		210		
61541	19	250	21	39	34	8,7	11,5	240		
61542	21	270	24	43	38	9,5	12,5	250		
61543	22	280	25	46	41	10,0	13,5	350		
61544	24	300	26	48	45	11,0		460	5	
61569	27	340	28,5	56	50	10	15,2	760		

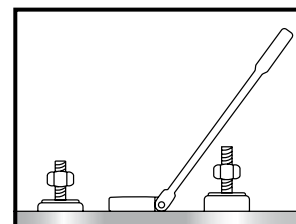
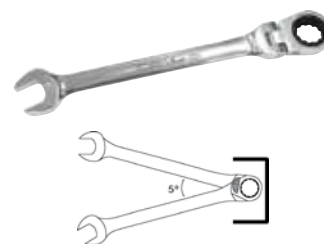

A Cromado pulido espejo / Mirror polished chrome plating / Polie chromée / Verchromt geschliffen / Cromate lucide / Cromado pulido / Полированный хром

Si no encuentra el artículo que necesita, consúltenos en consulta@egamaster.com o en www.egamaster.com
 If you can't find the item you look for, please ask us in consulta@egamaster.com or in www.egamaster.com
 Si vous ne trouvez pas l'article que vous desirez, consultez-nous a consulta@egamaster.com ou a www.egamaster.com

COD.	AP mm	L (mm)	A (mm)	B (mm)	C (mm)	D (mm)	E (mm)	g			
61582	30	365	32	63	55	11,5	16,8	900	5	●	A
61594	32	390	33,5	69	60	12,4	17,3	1000			

DIN 1711 | Modelo registrado / Registered model / Modèle enregistré

CARACTERÍSTICAS / FEATURES / CARACTÉRISTIQUES

Cr-V

INCH

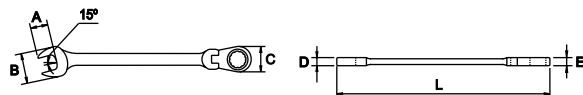

COD.	AP inch	L (mm)	A (mm)	B (mm)	C (mm)	D (mm)	E (mm)	g			
61545	5/16	145	9,0	17	18	4,7	7,4	60			
61546	3/8	155	12	22	21	5,7		70			
61547	7/16	165	23	22	22	6,1		90			
61548	1/2	180	14	26	25	6,6		110	10		
61549	9/16	190	16	29	26	7,3		130			
61550	5/8	210	18	33	29	7,7		170			
61551	11/16	230	20	36	30	7,9	10,0	190		●	A
61552	3/4	250	22	39	34	8,7	11,5	250			
61553	13/16	270	23	43	38	9,5	12,5	320			
61554	7/8	280	26	46	41	10,0		350	5		
61555	15/16	300	27	48	45	11,0	13,5	460			
61558	1	320	26	51	46	9,4	14,5	550			

DIN 1711 | Modelo registrado / Registered model / Modèle enregistré

CARACTERÍSTICAS / FEATURES / CARACTÉRISTIQUES

Cr-V

SET

MM

COD.	PCS.		COD. PCS.	(mm)
69105	6	90080	61530, 61532, 61534, 61535, 61539, 61541	8-10-12-13-17-19
69106	8	90081	61530, 61532, 61534, 61535, 61536, 61539, 61541, 61543	8-10-12-13-14-17-19-22
69107	10	90054	61530, 61531, 61532, 61533, 61534, 61535, 61536, 61539, 61541, 61543	8-9-10-11-12-13-14-17-19-22

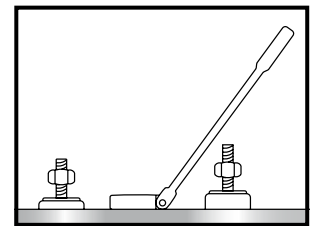
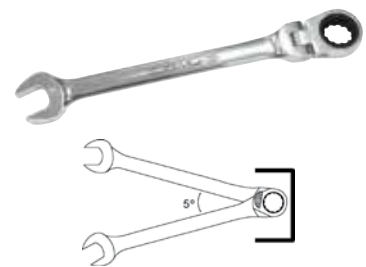





INCH

COD.	PCS.		COD. PCS.	(inch)
69101	6	90080	61546, 61547, 61548, 61549, 61550, 61552	3/8 - 7/16 - 1/2 - 9/16 - 5/8 - 3/4
69102	8	90081	61545, 61546, 61547, 61548, 61549, 61550, 61551, 61552	5/16 - 3/8 - 7/16 - 1/2 - 9/16 - 5/8 - 11/16 - 3/4
69103	10	90054	61546, 61547, 61548, 61549, 61550, 61551, 61552, 61553, 61554, 61555	3/8 - 7/16 - 1/2 - 9/16 - 5/8 - 11/16 - 3/4 - 13/16 - 7/8 - 15/16





■ MM

COD.		PCS.	
68525	A	10	1000
Composición / Composition / Composition			
61530, 61532, 61534, 61535, 61539, 61541		8-10-12-13-17-19 mm	
62772, 62773, 62774		1/4-10, 3/8-17, 1/2-19 mm	
62775		1/4"-1/4"	







■ MM

COD.		PCS.	
68526	A	6	800
Composición / Composition / Composition			
61530, 61532, 61534, 61535, 61539, 61541		8-10-12-13-17-19 mm	





■ MM

COD.		PCS.	
68527	A	16	2000
Composición / Composition / Composition			
61530, 61531, 61532, 61533, 61534, 61535, 61536, 61537, 61538, 61539, 61540, 61541		8-9-10-11-12-13-14-15-16-17-18-19 mm	
62772, 62773, 62774		1/4-10, 3/8-17, 1/2-19 mm	
62775		1/4"-1/4"	



■ MM

COD.		PCS.	
68528	A	12	1800
Composición / Composition / Composition			
61530, 61531, 61532, 61533, 61534, 61535, 61536, 61537, 61538, 61539, 61540, 61541		8-9-10-11-12-13-14-15-16-17-18-19 mm	



A Cromado pulido espejo / Mirror polished chrome plating / Polie chromée / Verchromt geschliffen / Cromate lucide / Cromado pulido / Полированный хром

Si no encuentra el artículo que necesita, consúltenos en consulta@egamaster.com o en www.egamaster.com
If you can't find the item you look for, please ask us in consulta@egamaster.com or in www.egamaster.com
Si vous ne trouvez pas l'article que vous desirez, consultez-nous a consulta@egamaster.com ou a www.egamaster.com

MASTERGEAR STUBBY

LLAVE COMBINADA DE CARRACA SERIE CORTA / STUBBY MASTERGEAR COMBINATION RATCHET WRENCH / CLÉ MIXTE À CLIQUET COURTE MASTERGEAR / RATSCHEN-RINGGABELSCHLÜSSEL STUBBY / CHIAVE COMBINATA A CRICCO SERIE CORTA MASTERGEAR / CHAVE DE BOCA E LUNETA ROQUETE SERIE CURTA MASTERGEAR / КЛЮЧ КОРОТКИЙ ТРЕЩЕТОЧНЫЙ КОМБИНИРОВАННЫЙ MASTERGEAR

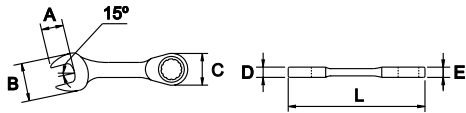
MM

COD.	AF mm	L (mm)	A (mm)	B (mm)	C (mm)	D (mm)	E (mm)	g		
62710	8	90	9,5	17	17	4,0	7,4	29	10	● A
62711	9		10	19	19		36			
62712	10	100	11	21	22	4,5	44			
62713	11	105	12	22	23	5,0	60			
62714	12		13	23	25	5,5	8,4	70		
62715	13	110	15	25	26	6,0	80			
62716	14	115	16	26	30		90			
62717	15	120	17	28	31	7,0	10,0	105		
62718	16		18	29	33	120				
62719	17	130	20	30	36	8,0	11,4	140		
62720	18		21	32	38		160			
62721	19	135	21	34	39	8,0	11,4	160		

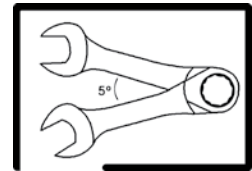
DIN 1711 | Modelo registrado / Registered model / Modèle enregistré
CARACTERÍSTICAS / FEATURES / CARACTÉRISTIQUES

Cr-V

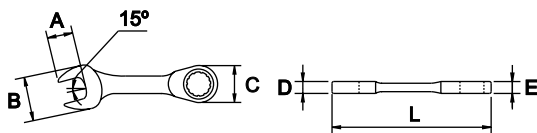
INCH

COD.	AF inch	L (mm)	A (mm)	B (mm)	C (mm)	D (mm)	E (mm)	g		
62722	5/16	90	9,0	17	17	4,0	7,4	29	10	● A
62723	3/8	100	12	21	22	4,5	44			
62724	7/16	105		22	23	5,0	60			
62725	1/2	110	14	25	26	6,0	8,4	70		
62726	9/16	115	16	26	30		80			
62727	5/8	120	17	29	33	7,0	10,0	105		
62728	11/16	130	20	30	36		120			
62729	3/4	135	22	34	39	8,0	11,4	160		

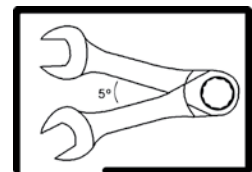
DIN 1711 | Modelo registrado / Registered model / Modèle enregistré
CARACTERÍSTICAS / FEATURES / CARACTÉRISTIQUES

Cr-V

■ SET

■ MM

COD.		PCS.	
69872	A	14	1300

Composición / Composition / Composition			
62712, 62713, 62714, 62715, 62716, 62717, 62718, 62719, 62720, 62721	10-11-12-13-14-15-16-17-18-19 mm		
62772, 62773, 62774	1/4-10, 3/8-17, 1/2-19 mm		
62775	1/4"-1/4"		



■ MM

COD.		PCS.	
69873	A	10	1100

Composición / Composition / Composition			
62712, 62713, 62714, 62715, 62716, 62717, 62718, 62719, 62720, 62721	10-11-12-13-14-15-16-17-18-19 mm		



ADAPTADOR PARA LLAVE / WRENCH ADAPTER / ADAPTATEUR POUR CLÉ / SCHRAUBENSCHLÜSSEL ADAPTER / ADATTATORE PER CHIAVE / ADAPTADOR PARA CHAVE / ПЕРЕХОДНИК ДЛЯ ГОЛОВОК

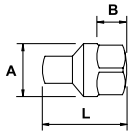

COD.		L (mm)	A (mm)	B (mm)			
62772	1/4"-10 mm	20	11	8	12		
62773	3/8"-17 mm	28	19	9	39	6	●
62774	1/2"-19 mm	35	22	13	65		



ADAPTADOR CON CLIP DE RETENCIÓN / RETENTION CLIP ADAPTER / ADAPTATEUR AVEC CLIP DE RÉTENTION / HALTEKLAMMER ADAPTOR / ADATTATORE CON CLIP DI RITENZIONE / ADAPTADOR COM CLIP DE RETENÇÃO / ПЕРЕХОДНИК (АДАПТЕР) С УДЕРЖИВАЮЩИМ ШАРИКОМ

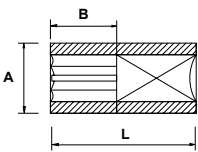





COD.		L (mm)	A (mm)	B (mm)			
62775	1/4"-1/4"	25	12	12	10	6	●

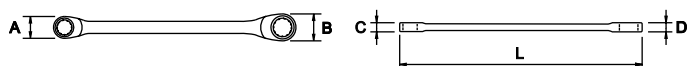

A Cromado pulido espejo / Mirror polished chrome plating / Polie chromée / Verchromt geschliffen / Cromate lucide / Cromado pulido / Полированный хром

Si no encuentra el artículo que necesita, consúltenos en consulta@egamaster.com o en www.egamaster.com
If you can't find the item you look for, please ask us in consulta@egamaster.com or in www.egamaster.com
Si vous ne trouvez pas l'article que vous desirez, consultez-nous a consulta@egamaster.com ou a www.egamaster.com

MASTERGEAR DOUBLE
LLAVE DE CARRACA DOBLE MASTERGEAR / MASTERGEAR DOUBLE RATCHET WRENCH / CLÉ À DOUBLE CLIQUET MASTERGEAR / MASTERGEAR DOPPEL KNARRE RINGSCHLÜSSEL / CHIAVE DOPPIA A CRICCO / CHAVE DE ROQUETE DUPLO MASTERGEAR / MASTERGEAR КЛЮЧ С ДВОЙНОЙ ТРЕЩЕТКОЙ
MM





COD.		L (mm)	A (mm)	B (mm)	C (mm)	D (mm)			
63280	8-9	149	18	21	7,4		60		
63281	10-11	167	21	22	8,4	8,4			
58095	12-13	185	26	26	8,5	9,0		8	
63282	12-15	225	23	28	8,4	8,4			
63283	13-14	250	25	26			150		● A
58096	14-15	202	29	29	9,7	9,7			
58097	16-17	220	32		10	10	200	8/8	
63284	16-18	270	29	32		11,5			
58098	18-19	238	35	36	11,1	11,3	250	8	
58099	20-22	255	40	40	13	13	390	5	

DIN 1711 | Modelo registrado / Registered model / Modèle enregistré

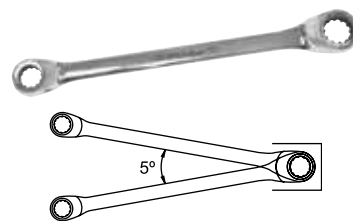
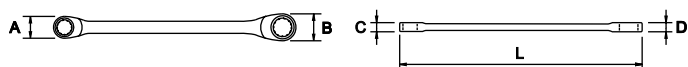
CARACTERÍSTICAS / FEATURES / CARACTÉRISTIQUES

Cr-V



INCH



COD.		L (mm)	A (mm)	B (mm)	C (mm)	D (mm)			
63288	5/16-3/8	160	18	21	7,5		60		
63289	3/8-7/16	165	21	24	8,5	8,5	90		
63290	1/2-9/16	195	25	28			150	8	● A
63291	11/16-3/4	230	30	34	10	12	250		
63292	13/16-15/16	320	38	45	13	14		5	

DIN 1711 | Modelo registrado / Registered model / Modèle enregistré

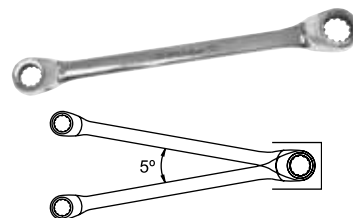
CARACTERÍSTICAS / FEATURES / CARACTÉRISTIQUES

Cr-V

SET
MM

COD.	PCS.		COD.	PCS.	(mm)
69990	A	6	90056	63280, 63281, 63282, 63283, 58097, 58098	8-9, 10-11, 12-15, 13-14, 16-17, 18-19



EXPOSITORES MASTERGEAR / MASTERGEAR DISPLAYS / PRÉSENTOIRS MASTERGEAR / MASTERGEAR AUSSTELLUNGSSTAND / ESPOSITORI MASTERGEAR / EXPOSITORES MASTERGEAR / ДИСПЛЕЙ С КЛЮЧАМИ MASTERGEAR

■ 186 PCS.

■ MM



COD.		PCS.	
55650		A	
		186	
PCS.	COD. PCS.	Mod.	
20	62651	8 mm	
	62653	10 mm	
	62654	11 mm	
	62655	12 mm	
	62656	13 mm	
	62657	14 mm	
16	62658	15 mm	
	62659	16 mm	
	62660	17 mm	
14	62662	19 mm	

■ MM

COD.		PCS.	
55651		A	
		186	
PCS.	COD. PCS.	Mod.	
20	62680	8 mm	
	62682	10 mm	
	62683	11 mm	
	62684	12 mm	
	62685	13 mm	
	62686	14 mm	
16	62687	15 mm	
	62688	16 mm	
	62689	17 mm	
14	62691	19 mm	

■ MM

COD.		PCS.	
55652		A	
		186	
PCS.	COD. PCS.	Mod.	
20	61530	8 mm	
	61532	10 mm	
	61533	11 mm	
	61534	12 mm	
	61535	13 mm	
	61536	14 mm	
16	61537	15 mm	
	61538	16 mm	
	61539	17 mm	
14	61541	19 mm	

MASTERGEAR ART. / MASTERGEAR JOINT

■ 180 PCS.

■ MM







COD.		PCS.	
65970		A	
		180	
PCS.	COD. PCS.	Mod.	
20	62653	10 mm	
	62655	12 mm	
	62656	13 mm	
	62660	17 mm	
16	62662	19 mm	
	62682	10 mm	
	62684	12 mm	
14	62685	13 mm	
	62689	17 mm	
14	62691	19 mm	

MASTERGEAR

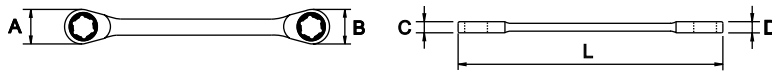
MASTERGEAR REV.

A Cromado pulido espejo / Mirror polished chrome plating / Polie chromée / Verchromt geschliffen / Cromate lucide / Cromado pulido / Полированный хром

MASTERGEAR E-TORX

COD.		L (mm)	A (mm)	B (mm)	C (mm)	D (mm)			
62734	E6 x E8	120	18	18	7,4	7,4	49	10	
62735	E10 x E12	135		19		8,4	60		
62736	E14 x E16	180	22	25	8,4		105	8	● A
62737	E18 x E20	200	26	29		10,0	145	10	
62738	E22 x E24	220	30	34	10,0	11,5	210		

DIN 1711 | Modelo registrado / Registered model / Modèle enregistré





CARACTERÍSTICAS / FEATURES / CARACTÉRISTIQUES

Cr-V

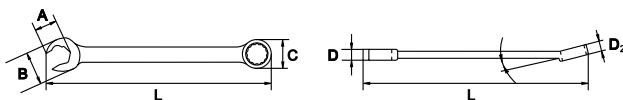
SET
MM

COD.	PCS.	COD. PCS.	Composición / Composition / Composition	
69874	A	5	62734, 62735, 62736, 62737, 62738	E6 x E8 - E10 x E12 - E14 x E16 - E18 x E20 - E22 x E24

RAPID WRENCH
LLAVE COMBINADA RÁPIDA / RAPID COMBINATION WRENCH / CLÉ MIXTE RAPIDE / RINGABELSCHLÜSSEL RAPID / CHIAVE COMBINATA RAPIDA / CHAVE BOCA E LUNETA DE RETOMA RAPIDA / БЫСТРЫЙ КОМБИНИРОВАННЫЙ КЛЮЧ
MM

COD.		L (mm)	A (mm)	B (mm)	C (mm)	D (mm)	D2 (mm)			
62740	8	140	6,5	18	15	5	7	32		
62742	10	160	8,0	22	17			55		
62743	11	170	9,5	24	19	6	8	70		
62744	12	175	10	26	20		7	80		
62745	13	180	11	28	21		7	90		
62746	14	195		31	23			110	10	
62747	15	210	12	33	24	8	10	135		
62748	16							150		
62749	17	230	14	37	27	9	12	170		● A
62750	18									
62751	19	250	16	41	30	10	13	220		
62752	20			45	32			290		
62753	21	270	17	47				320	5	
62754	22	300		50	34	11	14	350		
62755	23		19	55	37			395		
62756	24	320						470		
62757	26	340	21				16			

DIN 1711

CARACTERÍSTICAS / FEATURES / CARACTÉRISTIQUES

Cr-V

Acción carraca / Ratchet action / Action à cliquet

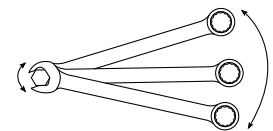
 Acción carraca / Ratchet action /
Action à cliquet

A Cromado pulido espejo / Mirror polished chrome plating / Polie chromée / Verchromt geschliffen / Cromate lucide / Cromado pulido / Полированный хром

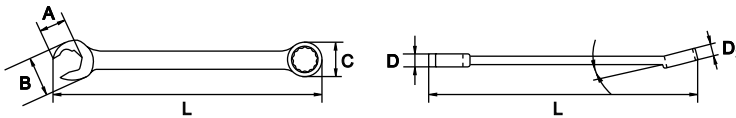
INCH

COD.	AF inch	L (mm)	A (mm)	B (mm)	C (mm)	D (mm)	D2 (mm)	g		
62759	3/8	160	8	22	17			55		
62760	7/16	170	9,5	24	19	6	8	70		
62761	1/2	180	11	28	21	7	9	90		
62762	9/16	195	12	31	23	8	10	110	10	
62763	5/8	210		33	24			150		
62764	11/16	230	14	37	27	9	12	170		● A
62765	3/4	250	16	41	30	10	13	220		
62766	13/16	270	17	45	32			290		
62767	7/8	300		47	34	11	14	320	5	
62768	15/16	320	19	50				395		
62769	1	340	21	55	37		16	470		

DIN 1711

CARACTERÍSTICAS / FEATURES / CARACTÉRISTIQUES

Cr-V

Acción carraca / Ratchet action / Action à cliquet

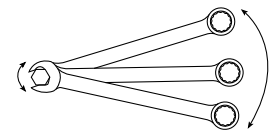
 Acción carraca / Ratchet action /
Action à cliquet

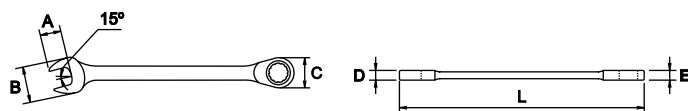
CLASSICGEAR
LLAVE COMBINADA DE CARRACA CLASSICGEAR / CLASSICGEAR COMBINATION RATCHET WRENCH / CLÉ MIXTE À CLIQUET CLASSICGEAR / RATCHEN-RINGGABELSCHLÜSSEL CLASSICGEAR / CHIAVI COMBINATE A CRICCO CLASSICGEAR / CHAVE DE BOCA E LUNETA DE ROQUETE CLASSICGEAR / CLASSICGEAR КОМБИНИРОВАННЫЙ КЛЮЧ С ТРЕЩЕТКОЙ
MM

COD.	AF mm	L (mm)	A (mm)	B (mm)	C (mm)	D (mm)	E (mm)	g		
63788	6	114		17	17	4,2	7	41		
63805	7		10							
63790	8	130		20	19	4,7	7,7	49		
63791	9									
63792	10	150	12	24	21	5,3	8,2	59		
63793	11	170	14	26	23	5,9	8,5	80		
63794	12	190	15	30	26	6,5	9,4	110	10	
63795	13		16							
63796	14	200	17	31	29	7,1	9,7	140		
63797	15									
63798	16	220	19	37	32	7,7	10,8	195		● A
63799	17		20							
63800	18	240	21	41	35	8,3	11,3	230		
63801	19									
63802	21	250	22	44	39	8,9	11,8	280		
63803	22		23							
63804	24	270	26	50	44	9,4	12,3	360		
63926	27	290		55	48	10,2	13,1	520	8	
63927	30	320	32	60	55	11,2	14,1	650		
63928	32	390	36	65		12,4	15,8	940		

DIN 1711

CARACTERÍSTICAS / FEATURES / CARACTÉRISTIQUES

Cr-V

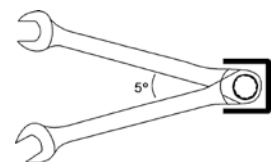

A Cromado pulido espejo / Mirror polished chrome plating / Polie chromée / Verchromt geschliffen / Cromate lucide / Cromado pulido / Полированный хром

 Si no encuentra el artículo que necesita, consúltenos en consulta@egamaster.com o en www.egamaster.com
 If you can't find the item you look for, please ask us in consulta@egamaster.com or in www.egamaster.com
 Si vous ne trouvez pas l'article que vous désirez, consultez-nous à consulta@egamaster.com ou à www.egamaster.com

INCH

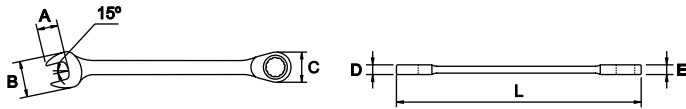

COD.	AF inch	L (mm)	A (mm)	B (mm)	C (mm)	D (mm)	E (mm)	g		
63806	5/16	130	10	20	19	4,7	7,7	50	10	● A
63807	3/8	150	12	24	21	5,3	8,2	60		
63808	7/16	170	14	26	23	5,9	8,5	80		
63809	1/2	190	16	30	26	6,5	9,4	110		
63810	9/16	200	17	31	29	7,1	9,7	140		
63811	5/8	220	20	37	32	7,7	10,8	195		
63812	11/16		21							
63813	3/4	240		41	35	8,3	11,3	230		
63814	13/16		22							
63815	7/8	250	23	44	39	8,9	11,8	280		
63816	1	290	31	50	44	10,2	13,1	440	8	

DIN 1711

CARACTERÍSTICAS / FEATURES / CARACTÉRISTIQUES

Cr-V

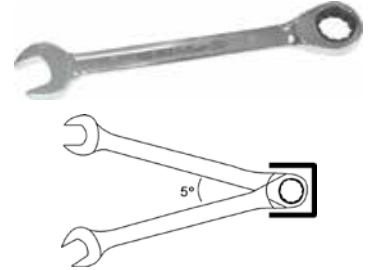

SET

MM

COD.	PCS.		COD. PCS.	(mm)
68230	6	90056	63790, 63792, 63794, 63795, 63799, 63801	8, 10, 12, 13, 17, 19
68231	A	90083	63790, 63791, 63792, 63793, 63794, 63795, 63796, 63797, 63798, 63799, 63800, 63801	8, 9, 10, 11, 12, 13, 14, 15, 16, 17, 18, 19



INCH

COD.	PCS.		COD. PCS.	(inch)
68232	6	90056	63806, 63807, 63808, 63809, 63812, 63813	5/16 - 3/8 - 7/16 - 1/2 - 11/16 - 3/4
68233	A	90054	63807, 63808, 63809, 63810, 63811, 63812, 63813, 63814, 63815, 63816	3/8 - 7/16 - 1/2 - 9/16 - 5/8 - 11/16 - 3/4 - 13/16 - 7/8 - 1



CLASSICGEAR ARTICULADA / CLASSICGEAR JOINT / CLASSICGEAR ARTICULÉE / RATSCHENRINGGABELSCHLUSSEL MIT VERSTELLBAREM KOPF / CLASSICGEAR SNODATA / CLASSICGEAR ARTICULADA / CLASSICGEAR ШАРНИР
LLAVE COMBINADA DE CARRACA ARTICULADA CLASSICGEAR / CLASSICGEAR JOINT COMBINATION RATCHET WRENCH / CLÉ MIXTE À CLIQUET ARTICULÉE CLASSICGEAR / RATSCHEN-RINGGABELSCHLÜSSEL MIT VERSTELBAREM KOPF / CHIAVI COMBINATE A CRICCO ARTICOLATA CLASSICGEAR / CHAVE DE BOCA E LUNETA DE ROQUETE ARTICULADO CLASSICGEAR / CLASSICGEAR КОМБИНИРОВАННЫЙ КЛЮЧ С ПОВОРТНОЙ ТРЕЩЕТКОЙ

MM

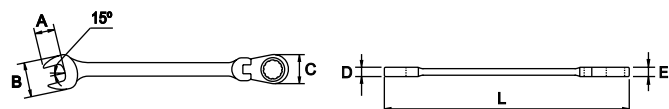

COD.	AF mm	L (mm)	A (mm)	B (mm)	C (mm)	D (mm)	E (mm)	g		
63833	6	124	10	17	17	4,2	7	50	10	A
63817	7									
63818	8									
63819	9									
63820	10	160	12	24	21	5,3	8,2	70		
63821	11									
63822	12									
63824	14	210	17	31	29	7,1	9,7	170		
63825	15									
63826	16									
63828	18	250	21	41	35	8,3	11,3	260		
63830	21									
63831	22									
63832	24	270	26	50	44	9,4	12,3	390		
63930	27									
63931	30									
63932	32	390	36	65	55	11,2	14,1	670		
	32									
	32									

DIN 1711

CARACTERÍSTICAS / FEATURES / CARACTÉRISTIQUES

Cr-V

INCH

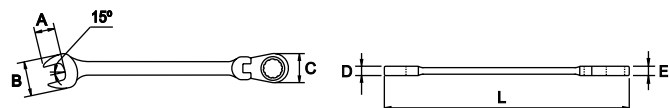

COD.	AF inch	L (mm)	A (mm)	B (mm)	C (mm)	D (mm)	E (mm)	g		
63834	5/16	140	10	20	19	4,7	7,7	50	10	A
63835	3/8									
63836	7/16									
63837	1/2	175	14	26	23	5,9	8,5	95		
63838	9/16									
63839	5/8									
63840	11/16	210	17	31	29	7,1	9,7	170		
63841	3/4									
63842	13/16									
63843	7/8	250	21	41	35	8,3	11,3	260		
63844	1									
	1									

DIN 1711

CARACTERÍSTICAS / FEATURES / CARACTÉRISTIQUES

Cr-V

A Cromado pulido espejo / Mirror polished chrome plating / Polie chromée / Verchromt geschliffen / Cromate lucide / Cromado pulido / Полированный хром

SET
MM

COD.	PCS.		COD. PCS.	(mm)
68234	6	90056	63818, 63820, 63822, 63823, 63827, 63829	8, 10, 12, 13, 17, 19
68235	12	90083	63818, 63819, 63820, 63821, 63822, 63823, 63824, 63825, 63826, 63828, 63829, 63827	8, 9, 10, 11, 12, 13, 14, 15, 16, 17, 18, 19

INCH

COD.	PCS.		COD. PCS.	(inch)
68236	6	90056	63834, 63835, 63836, 63837, 63840, 63841	5/16 - 3/8 - 7/16 - 1/2 - 11/16 - 3/4
68237	10	90054	63835, 63836, 63837, 63838, 63839, 63840, 63841, 63842, 63843, 63844	3/8 - 7/16 - 1/2 - 9/16 - 5/8 - 11/16 - 3/4 - 13/16 - 7/8 - 1

EXPOSITORES CLASSICGEAR / CLASSICGEAR DISPLAYS / PRÉSENTOIRS CLASSICGEAR / CLASSICGEAR AUSSTELLUNGSSTAND / ESPOSITORI CLASSICGEAR / EXPOSITORES CLASSICGEAR / ДИСПЛЕЙ С ГАЕЧНЫМИ КЛЮЧАМИ CLASSICGEAR
186 PCS.
MM

COD.	PCS.	Mod.
55653	A	186
PCS.	COD. PCS.	Mod.
20	63790	8 mm
	63792	10 mm
	63793	11 mm
	63794	12 mm
	63795	13 mm
	63796	14 mm
16	63797	15 mm
	63798	16 mm
14	63799	17 mm
	63801	19 mm



MM

COD.	PCS.	Mod.
55654	A	186
PCS.	COD. PCS.	Mod.
20	63818	8 mm
	63820	10 mm
	63821	11 mm
	63822	12 mm
	63823	13 mm
	63824	14 mm
16	63825	15 mm
	63826	16 mm
14	63827	17 mm
	63829	19 mm

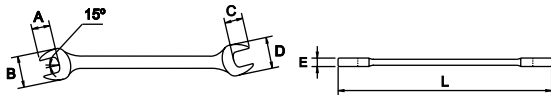

180 PCS.
MM

COD.			PCS.
65971	A		180
PCS.	COD.	PCS.	Mod.
20	63792	10 mm	CLASSICGEAR
	63794	12 mm	
	63795	13 mm	
16	63799	17 mm	
14	63801	19 mm	
	63820	10 mm	CLASSICGEAR ART. / CLASSICGEAR JOINT
20	63822	12 mm	
	63823	13 mm	
16	63827	17 mm	
14	63829	19 mm	

LLAVES FIJAS / OPEN-END WRENCHES / CLÉS À FOURCHE / GABELSCHLÜSSEL / CHIAVI FISSE / CHAVES DUAS BOCAS / РОЖКОВЫЕ КЛЮЧИ
MM

COD.	AF mm	L (mm)	A (mm)	B (mm)	C (mm)	D (mm)	E (mm)	g	5	B
67963	4-4,5			13		14				
67965	4-5	100					3,4	10		
67967	5-5,5		9,0	14	9,0	16				
67907	5-7							20		
61701	6-7	125		16	10	18	3,9	22		
62928	7-8							25		
61702	8-9	140	10	19		21		38		
67908	8-10							40		
61703	10-11	155		21	11	24		50		
62629	10-13		11							
67909	11-13			26			5,5	55		
61704	12-13	175	12			28				
67910	12-14			28				70		
67911	13-14									
67912	13-15	190				32				
67913	13-16				15		6,0	100		
61705	14-15		14	30		33				
67914	13-17					34		110		
62930	14-17	210		33			7,0			
61706	16-17					36				
67915	16-18			35	16			130		
61700	17-19		17							
61707	18-19	220	18	39	18	41		160		
67916	18-21					42	8,0			
62931	19-22	230	19	43	22	47		200		
61708	20-22									
61709	21-23	240								
63961	21-24		23	47	23	50		250		
67917	22-24	250								
61710	24-26	260					9,0			
61652	24-27		27	50	30	55		330		
61711	25-28	270						420		
61712	27-29	290	30					430		
67918	27-30	300	34	55	34	65	10	460		



A Cromado pulido espejo / Mirror polished chrome plating / Polie chromée / Verchromt geschliffen / Cromate lucide / Cromado polido / Полированный хром
 B Cromado aeroespacial / Aerospaceal chrome plating / Chromée aérospatiale / Verchromt aerospaceal / Cromate satinare / Cromado fosco aeroespacial / Матовый хром

Si no encuentra el artículo que necesita, consúltenos en consulta@egamaster.com o en www.egamaster.com
 If you can't find the item you look for, please ask us in consulta@egamaster.com or in www.egamaster.com
 Si vous ne trouvez pas l'article que vous desirez, consultez-nous a consulta@egamaster.com ou a www.egamaster.com

COD.	AF mm	L (mm)	A (mm)	B (mm)	C (mm)	D (mm)	E (mm)	g			
67919	27-32							460			
61713	30-32	320	34	60	35	65	11	500			
67970	36-41		36	80	42	70	12	850	5	●	B
67920	38-42	360		85		75		900			
67972	41-46	370	42	90	47	80	13	1200			
67974	46-50	400	47	100	50	90	14	1500			

DIN 3110

CARACTERÍSTICAS / FEATURES / CARACTÉRISTIQUES

Cr-V

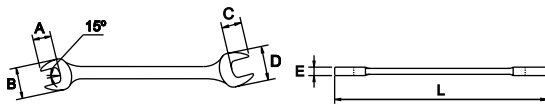
INCH

COD.	AF inch	L (mm)	A (mm)	B (mm)	C (mm)	D (mm)	E (mm)	g			
60315	3/16-7/32	105	4		5	15	3,7	15			
60300	1/4-5/16	120	8,0	14	9,0	17	3,6	22			
60301	5/16-3/8		10				3,8				
67941	5/16-11/32	140	11	20	12	22	4	38			
67931	11/32-13/32	145	12								
60302	3/8-7/16	160		22	13	24		50	10		
67942	7/16-1/2		13		26			55			
60303	1/2-9/16	175		26	15	28	5,5	60			
60304	9/16-5/8	190	14	27	17	33		70			
60305	19/32-11/16		17		19			85			
60306	5/8-11/16	200	18	35	18	38	6,0	115			
67943	5/8-3/4	210			20	36	7,0	125			
60307	11/16-3/4		19		38	40	6,0	130			
60308	3/4-25/32	220		38	21	41	6,5	160			
67934	3/4-13/16		21		44		7,0	190		●	A
60309	3/4-7/8	230		44	24	48		200			
60310	13/16-7/8		25		45		7,5	250			
67944	7/8-15/16	250		47	28	50		260			
60311	15/16-1	260		50				330	5		
67945	15/16-1.1/8		26		29		8,0	370			
67939	1-1.1/16				28	60		390			
60312	1-1.1/8	280		55	30			420			
60313	1.1/16-1.1/8		28		31		8,5	430			
60314	1.1/16-1.1/4	320		60				500			
67940	1.1/8-1.1/4		35		36	65	10	550			
67961	1.3/16-1.5/16	300									
67968	1.3/8-1.1/2		36		70	70		650			
67946	1.7/16-1.5/8	320			42	80	12	850	1		



DIN 3110

CARACTERÍSTICAS / FEATURES / CARACTÉRISTIQUES

Cr-V

■ SET

■ MM

COD.	PCS.		COD. PCS.	(mm)
69248	6	90052	61701, 61702, 61703, 61704, 61705, 61706	6-7, 8-9, 10-11, 12-13, 14-15, 16-17
69249	8	90053	61701, 61702, 61703, 61704, 61705, 61706, 61707, 61708	6-7, 8-9, 10-11, 12-13, 14-15, 16-17, 18-19, 20-22
69250	10	90054	61701, 61702, 61703, 61704, 61705, 61706, 61707, 61708, 61709, 61710	6-7, 8-9, 10-11, 12-13, 14-15, 16-17, 18-19, 20-22, 21-23, 24-26
69251	B		61701, 61702, 61703, 61704, 61705, 61706, 61707, 61708, 61709, 61710, 61711, 61713	6-7, 8-9, 10-11, 12-13, 14-15, 16-17, 18-19, 20-22, 21-23, 24-26, 25-28, 30-32
69795	12	90055	61701, 61702, 61703, 61704, 61705, 61706, 61707, 61708, 61709, 61652, 61711, 61713	6-7, 8-9, 10-11, 12-13, 14-15, 16-17, 18-19, 20-22, 21-23, 24-27, 25-28, 30-32

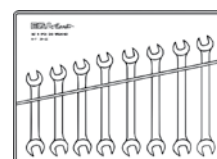

■ INCH

COD.	PCS.		COD. PCS.	(inch)
69310	6	90052	60302, 60303, 60304, 60305, 60306, 60310	3/8-7/16, 1/2-9/16, 9/16-5/8, 19/32-11/16, 5/8-11/16, 13/16-7/8
69311	8	90053	60302, 60303, 60304, 60305, 60306, 60310, 60309, 60311	3/8-7/16, 1/2-9/16, 9/16-5/8, 19/32-11/16, 5/8-11/16, 3/4-7/8, 13/16-7/8, 15/16-1
69312	A	90054	60300, 60301, 60302, 60303, 60304, 60306, 60310, 60311, 60312, 60314	1/4-5/16, 5/16-3/8, 3/8-7/16, 1/2-9/16, 9/16-5/8, 5/8-11/16, 13/16-7/8, 15/16-1, 1-1.1/8, 1.1/16-1.1/4
69313	12	90055	60300, 60301, 60302, 60303, 60304, 60306, 60310, 60311, 60312, 60313, 60314, 60309	1/4-5/16, 5/16-3/8, 3/8-7/16, 1/2-9/16, 9/16-5/8, 5/8-11/16, 3/4-7/8, 13/16-7/8, 15/16-1, 1-1.1/8, 1.1/16-1.1/8, 1.1/16-1.1/4

■ MM

COD.	PCS.	COD. PCS.	(mm)
68453	6	61701, 61702, 61703, 61704, 61705, 61706	6-7, 8-9, 10-11, 12-13, 14-15, 16-17
69446	8	61701, 61702, 61703, 61704, 61705, 61706, 61707, 61708	6-7, 8-9, 10-11, 12-13, 14-15, 16-17, 18-19, 20-22
68454	B	61701, 61702, 61703, 61704, 61705, 61706, 61707, 61708, 61709, 61710	6-7, 8-9, 10-11, 12-13, 14-15, 16-17, 18-19, 20-22, 21-23, 24-26
69447	12	61701, 61702, 61703, 61704, 61705, 61706, 61707, 61708, 61709, 61710, 61711, 61713	6-7, 8-9, 10-11, 12-13, 14-15, 16-17, 18-19, 20-22, 21-23, 24-26, 25-28, 30-32



■ INCH

COD.	PCS.	COD. PCS.	(inch)
68467	6	60302, 60303, 60304, 60305, 60306, 60310	3/8 - 7/16 - 1/2 - 9/16 - 5/8 - 19/32 - 11/16 - 5/8 - 11/16 - 13/16 - 7/8
69452	A	60301, 60302, 60303, 60304, 60305, 60306, 60308, 60310	5/16 - 3/8 - 3/8 - 7/16 - 1/2 - 9/16 - 9/16 - 5/8 - 19/32 - 11/16 - 5/8 - 11/16 - 3/4 - 7/8 - 13/16 - 7/8
69453	12	60300, 60301, 60302, 60303, 60304, 60306, 60309, 60310, 60311, 60312, 60313, 60314	1/4 - 5/16 - 5/16 - 3/8 - 3/8 - 7/16 - 1/2 - 9/16 - 9/16 - 5/8 - 5/8 - 11/16 - 3/4 - 7/8 - 13/16 - 7/8 - 15/16 - 1 - 1 - 1.1/8 - 1.1/16 - 1.1/8 - 1.1/16 - 1.1/4

B Cromado aeroespacial / Aersopacial chrome plating / Chromée aérospatiale / Verchromt aersopatial / Cromate satinare / Cromado fosco aeroespacial / Матовый хром
 A Cromado pulido espejo / Mirror polished chrome plating / Polie chromée / Verchromt geschliffen / Cromate lucide / Cromado pulido / Полированный хром

Si no encuentra el artículo que necesita, consúltenos en consulta@egamaster.com o en www.egamaster.com
 If you can't find the item you look for, please ask us in consulta@egamaster.com or in www.egamaster.com
 Si vous ne trouvez pas l'article que vous desirez, consultez-nous a consulta@egamaster.com ou a www.egamaster.com

LLAVES FIJAS MICROMECAÑICAS A 15° Y 75° / 15° AND 75° MICROMECH OPEN END WRENCHES / CLÉS À FOURCHES MICROMÉCANIQUES À 15° ET 75° / DOPPELMAULSCHLÜSSEL ELEKTRIKER 15° UND 75° MAULEINSTELLUNG / CHIAVI FISSE MICRO MECCANICHE A 15° Y 75° / CHAVES DE BOCAS MICROMECAÑICAS DE 150 E 750 / РОЖКОВЫЙ КЛЮЧ ДЛЯ МИКРОМЕХАНИКИ 15° И 75°

MM

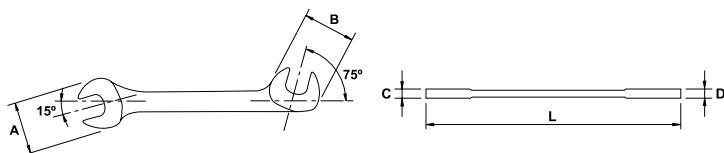

COD.	AF mm	L (mm)	A (mm)	B (mm)	C (mm)	D (mm)	g			
58520	3,2mm	70	10	10	2.4	2.4	6	20	●	B
58521	4mm									
58522	4,5mm									
58523	5mm	75	13	13	3	3	8	20	●	B
58524	5,5mm									
58525	6mm									
58526	7mm	80	15	15	2.7	2.7	10	20	●	B
58527	8mm									
58528	9mm									
58529	10mm	90	19	19	3	3	16	20	●	B
58530	11mm									
58531	12mm									
58532	13mm	120	27	27	3.5	3.5	36	20	●	B
58533	14mm									
58534	15mm									
58535	16mm	139.4	33	33	5	5	68	20	●	B
58536	17mm									

CARACTERÍSTICAS / FEATURES / CARACTÉRISTIQUES

Cr-V

INCH

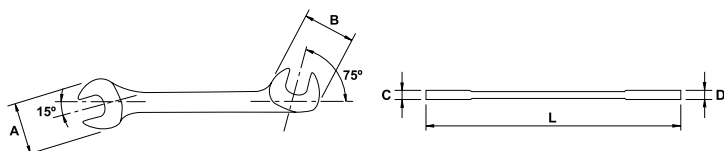



COD.	AF inch	L (mm)	A (mm)	B (mm)	C (mm)	D (mm)	g			
58550	1/8	70	10	10	2.4	2.4	6	20	●	B
58537	5/32									
58538	3/16									
58539	7/32	75	13	13	3	3	8	20	●	B
58540	1/4									
58541	9/32									
58542	5/16	80	15	15	2.7	2.7	10	20	●	B
58543	11/32									
58544	3/8									
58545	7/16	90	19	19	3	3	16	20	●	B
58546	1/2									
58547	9/16									
58548	5/8	120	27	27	3.5	3.5	36	20	●	B
58549	11/16									

CARACTERÍSTICAS / FEATURES / CARACTÉRISTIQUES

Cr-V

B Cromado aeroespacial / Aeraspatial chrome plating / Chromée aérospatiale / Verchromt aeraspatiale / Cromate satinata / Cromado fosco aeroespacial / Матовый хром





SET

COD.	PCS.		
51651	11	51071	0,6
PCS. Composición / Composition / Composition			
11	58537, 58538, 58539, 58540, 58541, 58542, 58543, 58544, 58545, 58546, 58547		5/32"-3/16"-7/32"-1/4"-9/32"-5/16"-11/32"-3/8"-7/16"-1/2"-9/16"

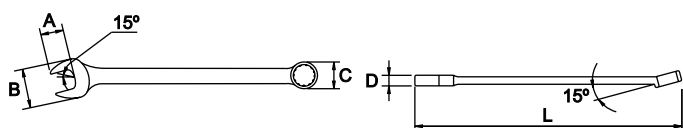
LLAVES COMBINADAS / COMBINATION WRENCHES / CLÉS MIXTES / RINGGABELSCHLÜSSEL / CHIAVI COMBINATE / CHAVES BOCA E LUNETA / КОМБИНИРОВАННЫЕ КЛЮЧИ





MM



COD.		L (mm)	A (mm)	B (mm)	C (mm)	D (mm)			
63965	3,2	70		11	10		8,0		
63966	4	65		8,5	8,0		9,0		
67880	4,5	70		9,0	8,5	3,0	10		
63967	5	80		11	9,0				
67881	5,5			14	11		16		
61725	6	100				3,3			
61726	7	110		16	12	3,6	20		
61727	8	120		18	13	4,5	25		
61728	9	130	10	19	15	5,0	30		
61729	10	140	11	21	17		38		
61730	11		12	23	18	5,5	45	10	
61731	12	160	14	25	19		52		
61732	13		15	27	20		70		
61733	14	180		29	21	6,5	75		
61734	15	190	16	32	23		90		
61735	16	200		33	24				
61736	17		18	35	26	7,5	110		
61737	18	210		38	26		135		
61738	19	230	21	39	29		160		
61739	20	240	23	41	30		180		
61740	21	250	24	46	31	8,0	210		
61741	22	260	25	48	33		220		B
61742	23						260		
61743	24	280	26	49	35		280		
61744	25			50	36		290		
61745	26	300	29		37	9,0	360		
61746	27	330		55	41	10	420		
61747	28		32	60	42		450	5	
61748	29				42	11	500		
61749	30	340	33	65	43		550		
62730	31		32,5	60,5	43,5	10,2	488		
61750	32	350		65	47	11			
57062	33	360	34	70	49		600		
60951	34	385		75	52	14			
57063	35	380	35				650		
60952	36	405		80	55	15	900		
57064	37	400	36	75	60	14	800		
60953	38	410	38	83	58	16	1000	1	-
67895	40								
60954	41	450	41	88	63	17	1300		
57065	42	440	42	85	60		1200		
57066	44	500	46	90	65	16	1500		



B Cromado aeroespacial / Aerspatial chrome plating / Chromée aérospatiale / Verchromt aerspatial / Cromate satinato / Cromado fosco aeroespacial / Матовый хром





COD.		L (mm)	A (mm)	B (mm)	C (mm)	D (mm)			
60955	46	500	46	96	70	18	1800		
57067	48	530	48	100	75		2200		
60956	50	535	50	105	76	19	2300	1	-
67882	55	600	60		80		3000		B
67883	60	650	65	115	90	21	3550		
67884	65	700	70	125	95	23	3800		

DIN 3113

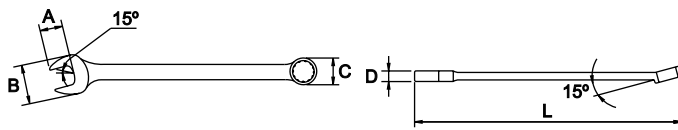



CARACTERÍSTICAS / FEATURES / CARACTÉRISTIQUES

Cr-V

INCH

COD.		L (mm)	A (mm)	B (mm)	C (mm)	D (mm)			
58169	1/8	70	3,7	11					
67953	3/16	95	5,0			3,0	8,0		
67954	7/32			14	9,0				
61653	15/64	100	6,5			3,8	16		
60340	1/4								
67885	9/32	110	7	20	12,5	4	17		
60341	5/16	120	9,0	17	12	4,5	25		
67878	11/32	130	10	19	15	5,5	28		
60342	3/8	140	11	26	16		38		
58460	13/32	142,5	10	27	17	5			
60343	7/16	170	14	26		6,0	45		
58461	15/32	162,5	12	32	20	5,5	58		
60344	1/2	180	15	29	21	6,5	70	10	
58462	17/32	182,5	14	35	23		76		
60345	9/16	180	16	29	21	7,0	75		
60346	19/32	190		31	23	7,5	90		
60347	5/8	200	17	32	25				
58463	21/32	212,5		42	27	8	126		
60348	11/16	220	19	37	28	8,0	130		
58464	23/32	222,5	18	44	28,5	9	138		A
60349	3/4	220	20	37	28		160		
60350	25/32	240	22	41	31	8,0	180		
60351	13/16	250	23	43	32	8,5	210		
58465	27/32	252,5	21	50	33,5	10			
60352	7/8	280	24	48	35	8,5	220	5	
58466	29/32	272,5	23	56	38	12	244	10	
60353	15/16	290	26	50	36	8,5	280	5	
58467	31/32	292,5	25	58	40	12	321	10	
60354	1	290	27	50	38		300		
60355	1.1/16	310	29	55	39	9,0	420		
60356	1.1/8	360	33		42	10	450	5	
60357	1.3/16		60		43		500		
60358	1.1/4	390	34		45		600		
60957	1.5/16	380		65	51	13			
60958	1.3/8	405	36	80	55	15	900		
60961	1.7/16								
60959	1.1/2	407	38	83	58	16	1000	1	-
67840	1.9/16	410	39	80	60				
60962	1.5/8	446	41	88	63	17	1300		



COD.		L (mm)	A (mm)	B (mm)	C (mm)	D (mm)			
67841	1.11/16	450	41	90	65	17	1300		
60897	1.3/4								
60898	1.13/16	500	46	96	70	18	1800		
60899	1.7/8								
67842	1.15/16	550			75				
60960	2	535	50		76	19	2300	1	- A
60905	2.3/16		105				2200		
61099	2.1/4	600	55		80	20	2800		
67955	2.3/8	650	60	115	90	21	2900		
67956	2.1/2	700	65	125	95	23	2300		

DIN 3113

CARACTERÍSTICAS / FEATURES / CARACTÉRISTIQUES

Cr-V

SET

MM

COD.	PCS.		COD. PCS.	(mm)
69262	6	90080	61727, 61729, 61731, 61733, 61736, 61738	8, 10, 12, 14, 17, 19
69263	8	90081	61727, 61729, 61731, 61732, 61733, 61736, 61738, 61741	8, 10, 12, 13, 14, 17, 19, 22
69277	10	90082	61727, 61728, 61729, 61730, 61731, 61732, 61733, 61736, 61738, 61741	8, 9, 10, 11, 12, 13, 14, 17, 19, 22
69278	12	90083	61725, 61726, 61727, 61728, 61729, 61730, 61731, 61732, 61733, 61734, 61735, 61736	6, 7, 8, 9, 10, 11, 12, 13, 14, 15, 16, 17
68514	13	90060	61725, 61727, 61729, 61730, 61732, 61733, 61734, 61736, 61738, 61739, 61741, 61743, 61744	6, 8, 10, 11, 13, 14, 15, 17, 19, 20, 22, 24, 25
69265	14	90063	61729, 61730, 61731, 61733, 61735, 61736, 61738, 61739, 61741, 61743, 61744, 61746, 61747, 61750	10, 11, 12, 14, 16, 17, 19, 20, 22, 24, 25, 27, 28, 32
69796	B		61729, 61730, 61731, 61733, 61735, 61736, 61738, 61739, 61741, 61743, 61744, 61746, 61749, 61750	10, 11, 12, 14, 16, 17, 19, 20, 22, 24, 25, 27, 30, 32
68522	15	90061	61729, 61730, 61732, 61733, 61734, 61736, 61738, 61739, 61741, 61743, 61746, 61748, 61749, 61750, 61744	10, 11, 13, 14, 15, 17, 19, 20, 22, 24, 25, 27, 29, 30, 32
69279	17	90064	61725, 61726, 61727, 61728, 61729, 61730, 61731, 61732, 61733, 61734, 61735, 61736, 61737, 61738, 61739, 61740, 61741	6, 7, 8, 9, 10, 11, 12, 13, 14, 15, 16, 17, 18, 19, 20, 21, 22
69556			61726, 61727, 61728, 61729, 61730, 61731, 61732, 61733, 61734, 61735, 61736, 61737, 61738, 61739, 61740, 61741, 61743	7, 8, 9, 10, 11, 12, 13, 14, 15, 16, 17, 18, 19, 20, 21, 22, 24
69280	26	90065	61725, 61726, 61727, 61728, 61729, 61730, 61731, 61732, 61733, 61734, 61735, 61736, 61737, 61738, 61739, 61740, 61741, 61742, 61743, 61744, 61745, 61746, 61747, 61748, 61749, 61750	6, 7, 8, 9, 10, 11, 12, 13, 14, 15, 16, 17, 18, 19, 20, 21, 22, 23, 24, 25, 26, 27, 28, 29, 30, 32

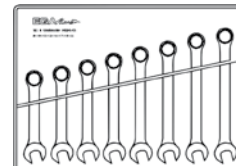
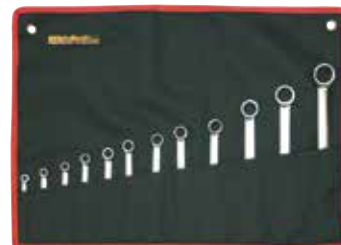

INCH

COD.	PCS.		COD. PCS.	(inch)
69330	6	90080	60342, 60343, 60344, 60345, 60347, 60349	3/8, 7/16, 1/2, 9/16, 5/8, 3/4
69331	8	90081	60341, 60342, 60343, 60344, 60345, 60347, 60348, 60349	5/16, 3/8, 7/16, 1/2, 9/16, 5/8, 11/16, 3/4
69332	10	90082	60342, 60343, 60344, 60345, 60347, 60348, 60349, 60351, 60352, 60354	3/8, 7/16, 1/2, 9/16, 5/8, 11/16, 3/4, 13/16, 7/8, 1
69333	12	90083	60341, 60342, 60343, 60344, 60345, 60347, 60348, 60349, 60351, 60352, 60353, 60354	5/16, 3/8, 7/16, 1/2, 9/16, 5/8, 11/16, 3/4, 13/16, 7/8, 15/16, 1
68502	A	90060	60340, 60341, 60342, 60343, 60344, 60345, 60347, 60348, 60349, 60351, 60352, 60353, 60354	1/4, 5/16, 3/8, 7/16, 1/2, 9/16, 5/8, 11/16, 3/4, 13/16, 7/8, 15/16, 1
69334	14	90063	60342, 60343, 60344, 60345, 60347, 60348, 60349, 60351, 60352, 60353, 60354, 60355, 60356, 60358	3/8, 7/16, 1/2, 9/16, 5/8, 11/16, 3/4, 13/16, 7/8, 15/16, 1, 1.1/16, 1.1/8, 1.1/4
68505	15	90061	60342, 60343, 60344, 60345, 60347, 60348, 60349, 60351, 60352, 60353, 60354, 60355, 60356, 60357, 60358	3/8, 7/16, 1/2, 9/16, 5/8, 11/16, 3/4, 13/16, 7/8, 15/16, 1, 1.1/16, 1.1/8, 1.3/16, 1.1/4
69335	17	90064	60340, 60341, 60342, 60343, 60344, 60345, 60346, 60347, 60348, 60349, 60350, 60351, 60352, 60353, 60354, 60355, 60356	1/4, 5/16, 3/8, 7/16, 1/2, 9/16, 19/32, 5/8, 11/16, 3/4, 25/32, 13/16, 7/8, 15/16, 1, 1.1/16, 1.1/8

A Cromado pulido espejo / Mirror polished chrome plating / Polie chromée / Verchromt geschliffen / Cromate lucide / Cromado pulido / Полированный хром

B Cromado aeroespacial / Aerospaceal chrome plating / Chromée aérospatiale / Verchromt aerospaceal / Cromate satinato / Cromado fosco aeroespacial / Матовый хром

Si no encuentra el artículo que necesita, consúltenos en consulta@egamaster.com o en www.egamaster.com
If you can't find the item you look for, please ask us in consulta@egamaster.com or in www.egamaster.com
Si vous ne trouvez pas l'article que vous désirez, consultez-nous a consulta@egamaster.com ou a www.egamaster.com

■ MM

COD.	PCS.	COD. PCS.	(mm)
68457	6	61727, 61729, 61731, 61733, 61736, 61738	8, 10, 12, 14, 17, 19
69450	8	61727, 61728, 61729, 61730, 61731, 61733, 61736, 61738	8, 9, 10, 11, 12, 14, 17, 19
68456	10	61727, 61728, 61729, 61730, 61731, 61732, 61733, 61736, 61738, 61741	8, 9, 10, 11, 12, 13, 14, 17, 19, 22
69451	12	61725, 61726, 61727, 61728, 61729, 61730, 61731, 61732, 61733, 61734, 61735, 61736	6, 7, 8, 9, 10, 11, 12, 13, 14, 15, 16, 17



■ INCH

COD.	PCS.	COD. PCS.	(inch)
68469	6	60342, 60343, 60344, 60345, 60347, 60349	3/8 - 7/16 - 1/2 - 9/16 - 5/8 - 3/4
69454	8	60341, 60342, 60343, 60344, 60345, 60347, 60348, 60349	5/16 - 3/8 - 7/16 - 1/2 - 9/16 - 5/8 - 11/16 - 3/4
68470	10	60342, 60343, 60344, 60345, 60347, 60348, 60349, 60351, 60352, 60354	3/8 - 7/16 - 1/2 - 9/16 - 5/8 - 11/16 - 3/4 - 13/16 - 7/8 - 1
69455	12	60341, 60342, 60343, 60344, 60345, 60348, 60347, 60349, 60351, 60352, 60353, 60354	5/16 - 3/8 - 7/16 - 1/2 - 9/16 - 5/8 - 11/16 - 3/4 - 13/16 - 7/8 - 15/16 - 1

■ EXPOSITORES / DISPLAYS / PRESENTOIRS / DISPLAY / ESPOSITORI / DISPLAY STAND / СТЕНДЫ

■ 165 PCS.

■ MM

COD.	PCS.	COD. PCS.	(mm)
55656	B		165
	20	61727	8 mm
		61729	10 mm
		61730	11 mm
		61731	12 mm
		61732	13 mm
	15	61733	14 mm
	14	61734	15 mm
	13	61735	16 mm
	12	61736	17 mm
	11	61738	19 mm



■ 162 PCS.

■ INCH

COD.	PCS.	COD. PCS.	(inch)
55657	A		162
	20	60342	3/8"
		60343	7/16"
		60344	1/2"
		60345	9/16"
	17	60347	5/8"
	15	60348	11/16"
		60349	3/4"
	13	60351	13/16"
	12	60352	7/8"
	10	60354	1"

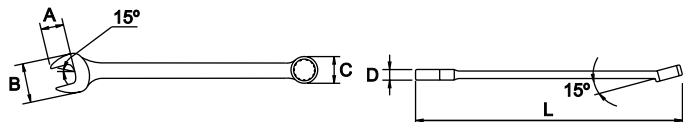

LLAVES COMBINADAS EXTRA LARGAS / EXTRA-LONG COMBINATION WRENCHES / CLÉS MIXTES EXTRA-LONGUES / RINGMAULSCHLÜSSEL EXTRA LANG / CHIAVE COMBINATA EXTRA LUNGHE / CHAVES COMBINADAS EXTRA-LARGAS / КЛЮЧ КОМБИНИРОВАННЫЙ УДЛИНЕННЫЙ
MM

COD.	AF mm	L (mm)	A (mm)	B (mm)	C (mm)	D (mm)	g		
56405	6	130	7	14	11	5	18		
56406	7	140		15	12	5,5	20		
56407	8	150	10	18	14	6	30		
56408	9	160		20	15	6,5	35		
56409	10	170	11	22	16	7	50		
56410	11	180	12	24	18	7,5	55		
56411	12	195	14	26	19	8	65		
56412	13	210	15	27	21	8,5	95		
56413	14	220		30	22	9,5	115		10
56414	15	230	16	32	23	10	120		
56415	16	240		34	24	11	160		
56416	17	250	18	37	27	12	190		
56417	18	270	21	38	28		195		
56418	19	280		40	29	13	260		B
56419	20	290	23	42	30		300		
56420	21	300	24	43		14	320		
56421	22	310	25	45	32		330		
56422	23	330		46	34	15	380		
56423	24	340	26	50	36	16	450		
56424	25	350		53	37	17			
56425	26	370	29	54	38	18	530		5
56426	27			56	40				
56427	28	390	32	57	41	19			
56428	29	410		59	43		760		
56429	30	420	33	60	44	20	820		
56430	32	440	34	65	47	21	1000		

DIN 3113

CARACTERÍSTICAS / FEATURES / CARACTÉRISTIQUES

Cr-V

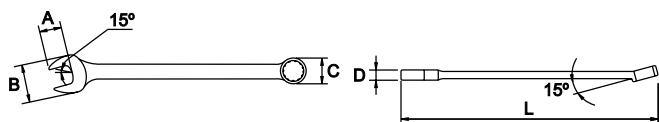
INCH

COD.	AF inch	L (mm)	A (mm)	B (mm)	C (mm)	D (mm)	g		
56432	3/4	280	19	40	29	8,5	260		
56433	13/16	300	21	43	32	9	320		10
56434	7/8	310	22	45	33	9,5	330		
56435	15/16	340	24	50	36	10	440		
56436	1	350	25	53	37	11	530		5
56437	1.1/16	390	27	56	40	12			
56438	1.1/8	410	29	59	43	13	760		
56439	1.1/4	440	32	65	47	14	1000		

DIN 3113

CARACTERÍSTICAS / FEATURES / CARACTÉRISTIQUES

Cr-V

A Cromado pulido espejo / Mirror polished chrome plating / Polie chromée / Verchromt geschliffen / Cromate lucide / Cromado polido / Полированный хром
 B Cromado aeroespacial / Aerospaceal chrome plating / Chromée aérospatiale / Verchromt aeroespaciaal / Cromate satinata / Cromado fosco aeroespacial / Матовый хром

Si no encuentra el artículo que necesita, consúltenos en consulta@egamaster.com o en www.egamaster.com
 If you can't find the item you look for, please ask us in consulta@egamaster.com or in www.egamaster.com
 Si vous ne trouvez pas l'article que vous desirez, consultez-nous a consulta@egamaster.com ou a www.egamaster.com

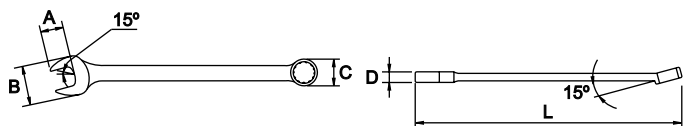
LLAVES COMBINADAS MAXI / MAXI COMBINATION WRENCHES / CLÉS MIXTES MAXI / MAXI RING-MAUL-SCHLÜSSEL / CHIAVI COMBINATE MAXI / CHAVAS COMBINADAS MAXI / КОМБИНИРОВАННЫЕ КЛЮЧИ МАКСИ
MM

COD.	AF mm	L (mm)	A (mm)	B (mm)	C (mm)	D (mm)	Kg		
55300	70								
55301	75	650	75	145	115	24	4,2		
55302	80	700	85	160	120	26	5,4		
55303	85								
55304	90								
55305	95	750	95	180	140		7,1		
55306	100	800	105	195	150		8,4	1	-
55307	105								
55308	110	850	115	210	165		9,8		
55309	115								
55310	120	900	125	230	180		12,1		
55311	125								

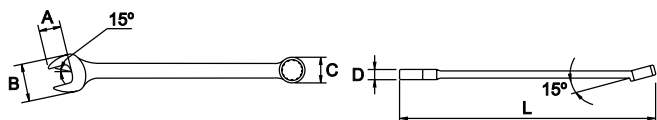

INCH

COD.	AF inch	L (mm)	A (mm)	B (mm)	C (mm)	D (mm)	Kg		
55322	2.3/4								
55312	3	650	75	145	115	24	4,2		
55313	3.1/4	700	85	160	120	26	5,3		
55314	3.1/2	750	95	180	140		7,2		
55315	3.3/4	800	105	195	150				
55323	3.7/8						8,4	1	-
55316	4								
55317	4.1/4	850	115	210	165		9,8		
55318	4.1/2								
55319	4.3/4	900	125	230	180		12,1		
55320	5								

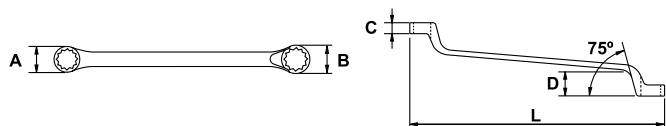

LLAVES ACODADAS / DOUBLE OFFSET RING WRENCHES / CLÉS POLYGONALES CONTRE-COUDÉES / RINGSCHLÜSSEL / CHIAVI POLIGONALI / CHAVES LUNETAS / КЛЮЧИ ДВОЙНАЯ ИЗОГНУТАЯ ЗВЕЗДОЧКА

MM



COD.	AF mm	L (mm)	A (mm)	B (mm)	C (mm)	D (mm)	g		
61774	5,5-6	165			4,5	19	45		
61775	6-7	170	11	12			50		
67843	7-8		13	16	6,5		55		
61776	8-9	180	15	17		17	65		
67844	8-10				7,0		55		
61777	10-11	200	17	19	7,5		85		
67845	10-12								
67846	10-13					22			
67847	11-13		19	20			90		
67848	11-14	220			9,0		110	10	
61778	12-13						120		
67849	12-14			21		23	125		
67850	13-14						140		
61779	14-15	240	21	24	9,5		155		
67851	13-16				10		160		
67852	13-17	250		23			180		
67853	14-17				11	25	200		
61780	16-17	260	25	27			220		
67854	16-18		27		12		270		
67855	17-19	290	28	29			280		B
61781	18-19					27	360		
67856	18-21		31	33	13	26	400	8	
67857	19-22	320	32	34		29	410		
61782	20-22		35				450		
61783	21-23		36	39			490		
67858	21-24	330				30	600		
67859	22-24		37	42	15		700		
61784	24-26	340					900		
61788	24-27		39	43			1100		
61785	25-28	350				32	1600	5	
61786	27-29		41	44	16		750		
67860	27-30	360	44	47		33	900		
61787	30-32	370	48	50	18	38	1100		
67861	32-36	400	55	50	19	41	1600		
67862	34-36	420	70	75		49	2000		
61789	36-41	550	65	60	21	45			
67863	41-46	460	70	75	20	50			
61790	46-50	550							



DIN 838





CARACTERÍSTICAS / FEATURES / CARACTÉRISTIQUES

Cr-V

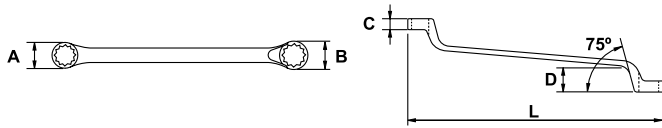
B Cromado aeroespacial / Aérospatial chrome plating / Chromée aérospatiale / Verchromt aérospatiale / Cromate satinato / Cromado fosco aeroespacial / Матовый хром

 Si no encuentra el artículo que necesita, consúltenos en consulta@egamaster.com o en www.egamaster.com
 If you can't find the item you look for, please ask us in consulta@egamaster.com or in www.egamaster.com
 Si vous ne trouvez pas l'article que vous desirez, consultez-nous a consulta@egamaster.com ou a www.egamaster.com

INCH



COD.		L (mm)	A (mm)	B (mm)	C (mm)	D (mm)				
60380	1/4-5/16	170	10	12	5,5	18	50			
67886	5/16-11/32	180	13	16	6,0	17	55			
60381	5/16-3/8	185	14	17	5,5	20	65			
60382	3/8-7/16	200	19	20	7,0	22	85			
67887	7/16-1/2	220	21	23	9,0	24	100			
60383	1/2-9/16	240	20	23	10	26	125	10		
60384	9/16-5/8	260	24	25	10	27	130			
60385	19/32-11/16	260	24	25	10	27	130			
60386	5/8-11/16	290	26	27	13	30	140			
67888	5/8-3/4	290	26	29	13	30	165			
60387	11/16-3/4	320	31	30	14	31	180			
67889	11/16-13/16	320	31	30	14	31	240			
60388	3/4-25/32	320	31	30	14	31	240			
60389	3/4-7/8	320	31	30	14	31	360			
67890	3/4-13/16	320	31	30	14	31	380			
60390	13/16-7/8	330	34	37	15	31	400			
67891	7/8-15/16	330	34	37	15	31	440			
67892	7/8-1.1/16	340	38	41	15	31	470	5		
60391	15/16-1	320	38	41	15	31	470			
67893	1-1.1/16	340	43	48	16	36	600			
60392	1-1.1/8	350	43	48	16	36	600			
60393	1.1/16-1.1/8	360	44	65	16	36	650			
60394	1.1/16-1.1/4	360	44	65	16	36	650			
67894	1.1/8-1.1/4	370	44	65	16	36	650			

DIN 838

CARACTERÍSTICAS / FEATURES / CARACTÉRISTIQUES

Cr-V

SET
MM

COD.	PCS.		COD. PCS.	(mm)
69255	6	90056	61778, 61775, 61776, 61777, 61779, 61780	6-7, 8-9, 10-11, 12-13, 14-15, 16-17
69239	8	90057	61778, 61775, 61776, 61777, 61779, 61780, 61781, 61782	6-7, 8-9, 10-11, 12-13, 14-15, 16-17, 18-19, 20-22
69256	B 10	90058	61778, 61775, 61776, 61777, 61779, 61780, 61781, 61782, 61783, 61784	6-7, 8-9, 10-11, 12-13, 14-15, 16-17, 18-19, 20-22, 21-23, 24-26
69257	12	90059	61778, 61782, 61783, 61784, 61785, 61787, 61775, 61776, 61777, 61779, 61780, 61781	6-7, 8-9, 10-11, 12-13, 14-15, 16-17, 18-19, 20-22, 21-23, 24-26, 25-28, 30-32

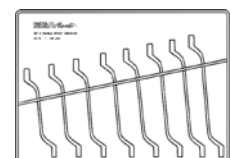

INCH

COD.	PCS.		COD. PCS.	(inch)
69320	6	90056	60382, 60383, 60384, 60385, 60386, 60390	3/8-7/16, 1/2-9/16, 9/16-5/8, 19/32-11/16, 5/8-11/16, 13/16-7/8
69321	8	90057	60382, 60383, 60384, 60385, 60386, 60390, 60389, 60391	3/8-7/16, 1/2-9/16, 9/16-5/8, 19/32-11/16, 5/8-11/16, 3/4-7/8, 13/16-7/8, 15/16-1
69322	A 10	90058	60380, 60381, 60382, 60383, 60384, 60386, 60390, 60391, 60392, 60394	1/4-5/16, 5/16-3/8, 3/8-7/16, 1/2-9/16, 9/16-5/8, 5/8-11/16, 13/16-7/8, 15/16-1, 1-1.1/8, 1.1/16-1.1/4
69323	12	90059	60381, 60382, 60383, 60384, 60386, 60390, 60391, 60392, 60393, 60394, 60380, 60389	1/4-5/16, 5/16-3/8, 3/8-7/16, 1/2-9/16, 9/16-5/8, 5/8-11/16, 3/4-7/8, 13/16-7/8, 15/16-1, 1-1.1/8, 1.1/16-1.1/4, 1.1/16-1.1/4

MM

COD.	PCS.	COD. PCS.	(mm)
68463	6	61778, 61775, 61776, 61777, 61779, 61780	6-7, 8-9, 10-11, 12-13, 14-15, 16-17
68464	B 8	61778, 61775, 61776, 61777, 61779, 61780, 61781, 61782	6-7, 8-9, 10-11, 12-13, 14-15, 16-17, 18-19, 20-22
68465	10	61780, 61782, 61776, 61784, 61775, 61777, 61779, 61781, 61783, 61778	6-7, 8-9, 10-11, 12-13, 14-15, 16-17, 18-19, 20-22, 21-23, 24-26

INCH

COD.	PCS.	COD. PCS.	(inch)
68471	6	60382, 60383, 60384, 60385, 60386, 60390	3/8-7/16 - 1/2-9/16 - 9/16-5/8 - 19/32-11/16 - 5/8-11/16 - 13/16-7/8
68472	A 8	60382, 60383, 60384, 60385, 60386, 60390, 60389, 60391	3/8-7/16, 1/2-9/16 - 9/16-5/8 - 19/32-11/16 - 5/8-11/16 - 3/4-7/8 - 13/16-7/8 - 15/16-1
68473	10	60380, 60381, 60382, 60383, 60384, 60386, 60387, 60389, 60390, 60391	1/4-5/16 - 5/16-3/8 - 3/8-7/16 - 1/2-9/16 - 9/16-5/8 - 5/8-11/16 - 11/16-3/4 - 3/4-7/8 - 13/16-7/8 - 15/16-1

EXPOSITORES / DISPLAYS / PRESENTOIRS / DISPLAY / ESPOSITORI / DISPLAY STAND / СТЕНДЫ
165 PCS.
MM

COD.	PCS.	COD. PCS.	(mm)
55658	B		165
	PCS.	COD. PCS.	(mm)
	20	61775	6-7 mm
		61776	8-9 mm
		61777	10-11 mm
		61778	12-13 mm
		61779	14-15 mm
	15	67852	13-17 mm
	14	61780	16-17 mm
	13	61781	18-19 mm
	12	67855	17-19 mm
	11	61782	20-21 mm





■ 162 PCS.

■ INCH

COD.		PCS.
55659	A	162
PCS.	COD. PCS.	
20	60380	1/4-5/16"
	60381	5/16-3/8"
	60382	3/8-7/16"
	60383	1/2-9/16"
	60384	9/16-5/8"
14	60385	19/32-11/16"
	67888	5/8-3/4"
12	60387	11/16-3/4"
	67889	11/16-13/16"
10	60390	13/16-7/8"





KIT DEMO 6 LLAVES / 6 SPANNER DEMO KIT / KIT DÉMO. 6 CLÉS / DEMOKIT 6 SCHLÜSSEL / KIT 6 CHIAVI DI DIMOSTRAZIONE / KIT DEMO 6 CHAVES / ДЕМО НАБОР 6 КЛЮЧЕЙ

COD.		
69342		300
COD. PCS.		
61727	Aerospacial / Aerospacial	8
38092	INOX	
73062	1000V	
70172	Cu-Be	
70684	Al-Bron	
71669	Titanio / Titanium	

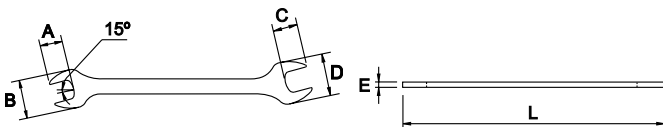
LLAVES FIJAS EXTRAFINAS / SLIM OPEN-END WRENCHES / CLÉS À FOURCHE EXTRA-FINES / DOPPELMAULSCHLÜSSEL EXTRA DÜNN / CHIAVI FISSE EXTRAFINE / CHAVE DE BOCAS EXTRA-FINA / ТОНКИЕ РОЖКОВЫЕ КЛЮЧИ

■ MM



COD.		L (mm)	A (mm)	B (mm)	C (mm)	D (mm)	E (mm)			
56200	6 x 7	150	7	17	8	20	2,2	21	10	● B
56201	8 x 9	175	9	21	10	25	2,6	40		
56202	10 x 11		11	29	12	34	3,6	85		
56203	12 x 13	210	13	38	14	43	4,6	170		
56204	14 x 15		16	49	17	55	5,6	330		
56205	16 x 17	250	18	55	18	65	6,6	400		
56206	18 x 19		20	65	21	75	7,6	450		
56207	20 x 22	290	22	75	22	85	8,6	500		
56208	21 x 23		24	85	26	95	9,6	550		
56209	22 x 24		26	95	26	95	9,6	550		





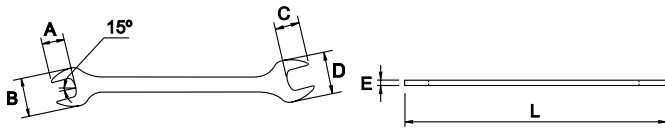

ISO 3318

CARACTERÍSTICAS / FEATURES / CARACTÉRISTIQUES

Cr-V

INCH

COD.		L (mm)	A (mm)	B (mm)	C (mm)	D (mm)	E (mm)			
56210	1/4 x 5/16	150	7	17	8	20	2,2	21		
56211	5/16 x 3/8	175	11	21	12	25	2,6	40		
56212	3/8 x 7/16	210	13	29	14	34	3,6	85	10	● B
56213	7/16 x 1/2	250	18	38	18	43	4,6	170		
56214	1/2 x 9/16	290	20	49	21	55	5,6	330		
56215	5/8 x 11/16		24		26					
56216	11/16 x 3/4									
56217	13/16 x 7/8									



ISO 3318

CARACTERÍSTICAS / FEATURES / CARACTÉRISTIQUES

Cr-V

SET
MM

COD.	PCS.		COD. PCS.	(mm)	(inch)
56226	6	90056	56201, 56202, 56203, 56204, 56205, 56206	8 x 9, 10 x 11, 12 x 13, 14 x 15, 16 x 17, 18 x 19	
56227	10	90054	56200, 56201, 56202, 56203, 56204, 56205, 56206, 56207, 56208, 56209	6 x 7, 8 x 9, 10 x 11, 12 x 13, 14 x 15, 16 x 17, 18 x 19, 20 x 22, 21 x 23, 22 x 24	-





INCH

COD.	PCS.		COD. PCS.	(mm)	(inch)
56228	6	90056	56212, 56213, 56214, 56215, 56216, 56217		3/8 x 7/16 - 7/16 x 1/2 - 1/2 x 9/16 - 5/8 x 11/16 - 11/16 x 3/4 - 13/16 x 7/8
56229	8	90081	56210, 56211, 56212, 56213, 56214, 56215, 56216, 56217		1/4 x 5/16 - 5/16 x 3/8 - 3/8 x 7/16 - 7/16 x 1/2 - 1/2 x 9/16 - 5/8 x 11/16 - 11/16 x 3/4 - 13/16 x 7/8

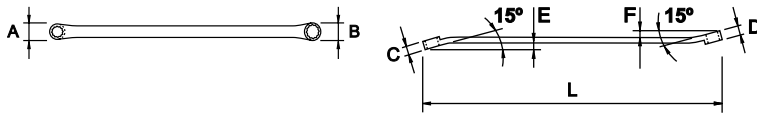
B Cromado aeroespacial / Aérospatiale chrome plating / Chromée aérospatiale / Verchromt aérospatiale / Cromate satinato / Cromado fosco aeroespacial / Матовый хром

Si no encuentra el artículo que necesita, consúltenos en consulta@egamaster.com o en www.egamaster.com
 If you can't find the item you look for, please ask us in consulta@egamaster.com or in www.egamaster.com
 Si vous ne trouvez pas l'article que vous désirez, consultez-nous a consulta@egamaster.com ou a www.egamaster.com





LLAVES ESTRELLA DE DOS BOCAS EXTRAFINAS COMPENSADAS A 15° / SLIM DOUBLE RING WRENCHES 15° BENT / CLÉS POLYGONALE DOUBLE EXTRA-FINES COMPENSÉES À 15° / DOPPEL-RINGSCHLÜSSEL DÜNN 15° GEKRÖPFT / CHIAVI POLIGONALI A DUE BOCHE A 15° / CHAVE DE LUNETA EXTRA-FINA DE 15° / ТОНКИЕ КЛЮЧИ ДВОЙНАЯ ЗВЕЗДОЧКА С ИЗГИБОМ НА 15°
MM

COD.		L (mm)	A (mm)	B (mm)	C (mm)	D (mm)	E (mm)	F (mm)			
58904	6-7	205	11	14	6,5	8	4	4	50		
58905	8-9	235	13	16	7,5	8	4,5	6	70		
58906	10-11	290	16	19	8	8,5	5	6,5	120		
58907	12-13	328	19	23	10	11	8	6	160	10	● B
58908	14-15	368	22	28	11	12	6	6	250		
58909	16-17	388	24	28	12,5	14	5	5	300		
58910	18-19	408	28	29	14	14,5	5	5	400		

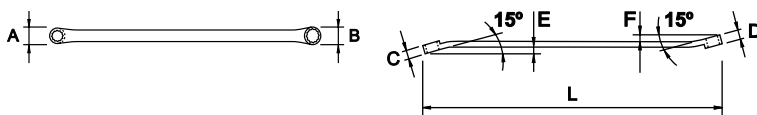
CARACTERÍSTICAS / FEATURES / CARACTÉRISTIQUES

Cr-V

INCH

COD.		L (mm)	A (mm)	B (mm)	C (mm)	D (mm)	E (mm)	F (mm)			
56230	7/32-1/4	205	11	14	6,5	7,5	4,0	4,0	50		
56231	1/4-5/16	235	13	16	7,5	8,0	4,5	6,0	70		
56232	5/16-3/8	290	16	19	8,0	9,0	5,0	5,5	120		
56233	3/8-7/16	330	19	21	10	11	8,0	6,5	160	10	● B
56234	1/2-9/16	390	25	27	13	14	5	5	300		
58911	5/8-11/16	410	27	29	14	15	5	5	400		



CARACTERÍSTICAS / FEATURES / CARACTÉRISTIQUES

Cr-V

SET
INCH

COD.	PCS.		COD. PCS.	(inch)
56240	B 5	90056	56230, 56231, 56232, 56233, 56234	7/32-1/4, 1/4-5/16, 5/16-3/8, 3/8-7/16, 1/2-9/16

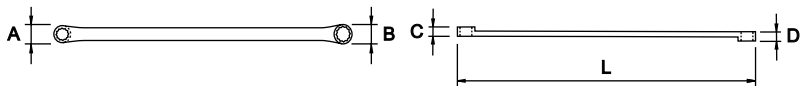

LLAVES ESTRELLA PLANAS DE DOS BOCAS EXTRAFINAS / SLIM FLAT DOUBLE RING WRENCHES / CLÉS POLYGONALE PLATES DOUBLE EXTRA-FINES / DOPPEL-RINGSCHLÜSSEL DÜNN / CHIAVI POLIGONALI PIATTE A DUE BOCCHE EXTRAFINE / CHAVE DE LUNETA PLANA EXTRA-FINA / ТОНКИЕ ПЛОСКИЕ КЛЮЧИ ДВОЙНАЯ ЗВЕЗДОЧКА
INCH

COD.	AF inch	L (mm)	A (mm)	B (mm)	C (mm)	D (mm)	g			
56235	7/32-1/4	205	11	13	6.5	7.5	50			
56236	1/4-5/16									
56237	5/16-3/8	235	13	16		8.0	75	10	●	B
56238	3/8-7/16	290	16	19	8.0	9.0	115			
56239	1/2-9/16	330	20	23	9.5	11	160			

DIN 838

CARACTERÍSTICAS / FEATURES / CARACTÉRISTIQUES

Cr-V

SET
INCH

COD.	PCS.		COD. PCS.	(inch)
56241	B 5	90056	56235, 56236, 56237, 56238, 56239	7/32-1/4, 1/4-5/16, 5/16-3/8, 3/8-7/16, 1/2-9/16

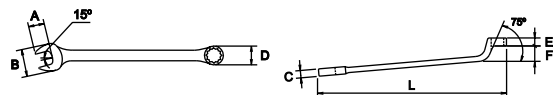
COMBINADA ACODADA / COMBINATION DEEP OFFSET SPANNER / MIXTE CONTRE-COUDÉE / RINGMAULSCHLÜSSEL / CHIAVE COMBINATA A CONTROGOMITO / BOCA E LUNETA CONTRA-COTOVELO / КОМБИНИРОВАННЫЕ КЛЮЧИ С ГЛУБОКИМ ИЗГИБОМ
MM

COD.	AF mm	L (mm)	A (mm)	B (mm)	C (mm)	D (mm)	E (mm)	F (mm)	g		
60740	6	115	9,5	17	3,7	12	6,0	5,0	17		
60741	7	125	10	20	4,0	13	6,5	5,5	25		
60742	8	140	11			14	7,5	6,0	23		
60743	9	145		23	4,5	15		7,0	40		
60744	10	150	12			16	8,0	7,5	43		
60745	11	170	14	27	5,0	18	8,5	8,0	65		
60746	12	185	15	30	5,5	20	9,0	8,5			
60747	13	190		31		21	9,5	12	90	10	
60748	14	200	16	31		22		16	95		
60749	15	210	18	35	6,0	24	10	18	115		● B
60750	16	230	19	38	8,0	26		20	130		
60751	17	250	20			27	12	21	170		
60752	18	260	21	40	8,5	29		21	175		
60753	19	280	22	43		31	13	23	240		
60755	21	290		46		33		24	250		
60756	22		23	47	9,0			25	270		
60757	23	300	24			34	14	26	320		
60758	24	320	26	49	9,5	36		26	350	5	
60759	25	340	28	50		38		30	380		

B Cromado aeroespacial / Aerspatial chrome plating / Chromée aérospatiale / Verchromt aerspatiale / Cromate satinata / Cromado fosco aerspatial / Матовый хром

COD.	AF mm	L (mm)	A (mm)	B (mm)	C (mm)	D (mm)	E (mm)	F (mm)	g	Icon 1	Icon 2
60760	26	350	28	50		38	14	30	420		
60761	27	360	29	55	10	39		30	410		
60762	28	370	30	60		42	16	32	470	5	●
60763	29	380	32			45		34	550		B
60764	30	400	33	65	11	46	18		600		
60765	32	410	34	70		47		35	750		

DIN 3113-B

CARACTERÍSTICAS / FEATURES / CARACTÉRISTIQUES

Cr-V

SET

MM

COD.	PCS.	Icon	COD. PCS.	(mm)
68568	8	90081	60742, 60743, 60744, 60745, 60746, 60747, 60748, 60751	8, 9, 10, 11, 12, 13, 14, 17
68569	12	90083	60742, 60743, 60744, 60745, 60746, 60747, 60748, 60749, 60751, 60752, 60753, 60756	8, 9, 10, 11, 12, 13, 14, 15, 17, 18, 19, 22



ESTRELLA PLANA / DOUBLE ENDED FLAT RING SPANNER / POLYGONALE PLATE / DOPPELRINGSCHLÜSSEL / POLIGONALE DIRITTA / LUNETTA DIREITA / ДВОЙНАЯ ИЗГНУТАЯ ПЛОСКАЯ ЗВЕЗДОЧКА

MM

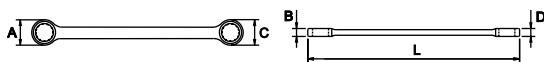

COD.	AF mm	L (mm)	A (mm)	B (mm)	C (mm)	D (mm)	g	Icon 1	Icon 2	Icon 3
60770	6-7	120	12	5	11	5	25			-
60771	8-9	135	15	5,5	13	5,5	30			
60772	10-11	150	17	6,4	16	6,4	50			
60773	12-13	165	21	7	20	7	70			
60774	14-15	185	24	8	21	8	90	10		
60775	16-17	210	27	8,5	24	8,5	120			
60776	17-19	225	29	9	27	9	150		●	B
60777	18-19	225	29	9	27	9	150			
60778	20-22	240	34	10	31	10	200			
60779	21-23	255	35	10,5	32	10,5	240			
60780	24-27	270	39	11	37	11	300	5		
60781	25-28	285	42	13	38	13	360			
60782	30-32	335	48	14	45	14	530			

DIN 837

CARACTERÍSTICAS / FEATURES / CARACTÉRISTIQUES

Cr-V

INCH

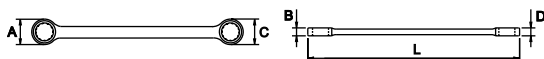

COD.	AF inch	Icon
57775	3/8-7/16	
57776	1/2-9/16	
57777	11/16-3/4	●
57778	13/16-7/8	B



B Cromado aeroespacial / Aerspatial chrome plating / Chromée aérospatiale / Verchromt aerspatiale / Cromate satinare / Cromado fosco aeroespacial / Матовый хром

COD.			
57779	15/16-1	●	B

DIN 837





CARACTERÍSTICAS / FEATURES / CARACTÉRISTIQUES

Cr-V

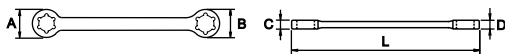
SET

COD.	PCS.		COD. PCS.	(mm)
68589	8	90081	60771, 60772, 60773, 60774, 60775, 60777, 60778, 60779	8-9, 10-11, 12-13, 14-15, 16-17, 18-19, 20-22, 21-23
68607	12	90083	60770, 60771, 60772, 60773, 60774, 60775, 60777, 60778, 60779, 60780, 60781, 60782	6-7, 8-9, 10-11, 12-13, 14-15, 16-17, 18-19, 20-22, 21-23, 24-27, 25-28, 30-32





TORX®*

COD.		L (mm)	A (mm)	B (mm)	C (mm)	D (mm)			
57718	E6 x E8	113	9	11	4.5	5.5	20		
57719	E7 x E11	127	12	16	6	7	29		
57720	E10 x E12	142	14	17	6.5	8	31	10	●
57721	E14 x E18	182	17	21	8	10	75		A
57722	E16 x E22	204	19	26	9	12	115		
57723	E20 x E24	224	25	29	11	13	160		

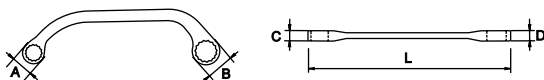
CARACTERÍSTICAS / FEATURES / CARACTÉRISTIQUES

Cr-V

MEDIA LUNA / HALF MOON / DEMI-LUNE / STARTER BLOCKSCHLÜSSEL / A MEZZALUNA / MEIA-LUNA / МОТОРНЫЙ КЛЮЧ
MM

COD.		L (mm)	A (mm)	B (mm)	C (mm)	D (mm)			
57158	6-8								
57155	7-9	135	15	19	8	8	55		
57159	8-10								
57156	10-12	150	20	22	9	9	90		
60795	11-13			23					
57160	13-15	175					110		
60796	13-17				10	10	120	10	●
57161	14-16	185	25	28			160		B
60797	14-17								
57162	17-19	210	28	31	11	11	180		
57157	18-20								
60798	19-22	230	31	35	12	12	280		
57163	21-22		32				300		



DIN 475

CARACTERÍSTICAS / FEATURES / CARACTÉRISTIQUES

Cr-V

B Cromado aeroespacial / Aeraspacial chrome plating / Chromée aérospatiale / Verchromt aeraspacial / Cromate satinato / Cromado fosco aeroespacial / Матовый хром

*Para tornillos TORX® (Marca registrada por Acument Intellectual Properties, LLC, Troy, Mich., US) / *For screws TORX® (Acument Intellectual Properties, LLC, Troy, Mich., US registered trademark) / *Pour vis TORX® (Marque enregistrée par Acument Intellectual Properties, LLC, Troy, Mich., US)

A Cromado pulido espejo / Mirror polished chrome plating / Polie chromée / Verchromt geschliffen / Cromate lucide / Cromado pulido / Полированный хром

INCH

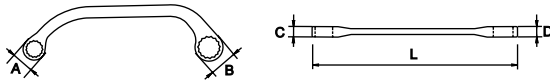

COD.	AF ⁺ / _{inch}	L (mm)	A (mm)	B (mm)	C (mm)	D (mm)	g			
57148	1/4 - 5/16	135	15	19	8,0	8,0	55	10	●	B
57149	5/16 - 3/8									
57150	7/16 - 1/2	155	20	23	9,0	9,0	90			
57151	9/16 - 5/8	185	25	28	10	10	160			
57152	11/16 - 3/4	210	28	31	11	11	210			
57153	13/16 - 7/8	230	32	35	12	12	300			

DIN 475

CARACTERÍSTICAS / FEATURES / CARACTÉRISTIQUES

Cr-V

PARA RACORES / FLARE NUT / POLYGONALE À TUYAUTER / OFFENER DOPPELRINGSCHLÜSSEL / CHIAVE PER RACCORDI / LUNETAS ABERTAS COM BATENTE / КЛЮЧ ПРОКАЧНОЙ РАЗРЕЗНОЙ

MM

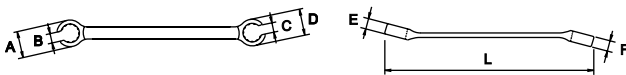

COD.	AF ⁺ / _{mm}	Pt	L (mm)	A (mm)	B (mm)	C (mm)	D (mm)	E (mm)	F (mm)	g			
60785	8-10	6	145	19	6,0	7,5	21	7,5	9,0	45	10	●	B
60786	9-11		150	21	6,5	9,0	22						
60787	10-11	12	165	22	8,5	10	25	10	16	100	8		
60788	11-13		180	25	9,5	11	28	9,0					
60789	12-14	12	210	31	14	15	34	12	13	165	8	●	B
60790	17-19		230	34	18	17	39	14					
60791	19-22	12	250	39	17	18	41	15	16	290	8		
60792	22-24		260	42	18	21	46	16					
60793	24-27	12	260	42	18	21	46	16	17	280	6		
60794	30-32		280	48	22	24	50	20					

DIN 3118

CARACTERÍSTICAS / FEATURES / CARACTÉRISTIQUES

Cr-V



INCH

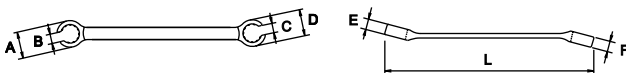

COD.	AF ⁺ / _{inch}	Pt	L (mm)	A (mm)	B (mm)	C (mm)	D (mm)	E (mm)	F (mm)	g			
58752	1/4 - 5/16	6	135	5	6	16,2	17,9	6,6	8,2	35	10	●	B
58753	5/16 - 3/8		145	6	7	18,4	20,8	7	8,5	45			
58754	3/8 - 7/16	12	152	6,5	8,5	20,8	22,6	8,5	9	60	8	●	B
58755	7/16 - 1/2		165	8,5	10	22,6	25	9	10,5	80			
58756	1/2 - 9/16	6-12	178	9	11	25	27,4	9,5	11	115	8	●	B
58757	9/16 - 5/8		196	11	14	27,4	30	11	12	140			
58758	5/8 - 11/16	12	210	14	15	30	32,5	12	14	180	6		
58759	11/16 - 3/4		233	15	17	32,5	38	14	16	245			
58760	13/16 - 7/8	12	265	18	20	41	45	17	18	350	6		
58761	1 - 1.1/8		285	22	24	48,5	51	21	23	465			
58762	1.1/8 - 1.1/4	12	285	22	24	48,5	51	21	23	465	6		

DIN 3118

CARACTERÍSTICAS / FEATURES / CARACTÉRISTIQUES

Cr-V

B Cromado aeroespacial / Aeraspacial chrome plating / Chromée aérospatiale / Verchromt aeraspaciale / Cromate satinata / Cromado fosco aeroespacial / Матовый хром

■ SET

■ MM

COD.	PCS.		COD. PCS.	(mm)
68587	6	90056	60785, 60788, 60789, 60790, 60792, 60793	8-10, 11-13, 12-14, 17-19, 22-24, 24-27
68588	10	90058	60785, 60786, 60787, 60788, 60789, 60790, 60791, 60792, 60793, 60794	8-10, 9-11, 10-11, 11-13, 12-14, 17-19, 19-22, 22-24, 24-27, 30-32



■ FIJA / OPEN-END / À FOURCHE / DOPPELMAULSCHLÜSSEL / CHIAVE FISSE / DUAS VOCAS / РОЖКОВЫЙ КЛЮЧ

■ MM

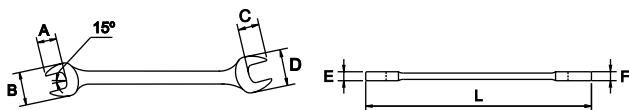





COD.		L (mm)	A (mm)	B (mm)	C (mm)	D (mm)	E (mm)	F (mm)			
60800	6-7	95	6,5	14	7,5	16	3,2	3,5	20		
60801	7-8	100	8,5	17	8,5	19	4,0	3,8	23		
60802	8-9	105		18	9,0	20		4,0	32		
60803	8-10	115	9,0		10	21	4,5	4,5	30		
60804	9-11			19							
60805	10-11	125		21	12	23		5,0	35		
60806	10-12		11			26					
60807	10-13	130		22					40		
60808	11-13				13						
60808	11-13	135		25		28			50		
60809	12-13		12				5,5	5,5			
60810	12-14	140		27	14				45		
60811	13-14					31			55	10	
60812	13-15			28				6,0	70		
60813	13-16	150			15						
60814	14-15		14			34	6,0		75		
60815	13-17	155		29					80		
60816	14-17							6,5			
60817	16-17	160		33	18	35			85		
60818	16-18		16	34			6,5		110		
60819	17-19				19	36			135		
60820	18-19	170		35	20	38		7,5	130		
60821	18-21		18			39	7,0		140		
60822	17-22					44					
60823	19-22	190	19	37	22	45	8,0	8,0	170		
60824	20-22	195		38					165		
60825	19-24	210	20	39		46		8,5	180		
60826	21-23		22		23	48					
60827	21-24	220	23	44	24			9,0	200		
60828	22-24					49					
60829	22-27			48	25	50	9,0		240	5	
60830	24-27	240	24	49	26				260		
60831	25-28	250			28	55	9,5		350		
60832	24-30	260	25	50							
60833	27-30		26	55	29	60	10	10	340		
60834	27-32	270							400		
60835	30-32		28	60	30	65		11	450		
60836	30-34	290	29		32	70	12	12	500		



B Cromado aeroespacial / Aeraspacial chrome plating / Chromée aérospatiale / Verchromt aeraspaciale / Cromate satinata / Cromado fosco aeroespacial / Матовый хром

Si no encuentra el artículo que necesita, consúltenos en consulta@egamaster.com o en www.egamaster.com
If you can't find the item you look for, please ask us in consulta@egamaster.com or in www.egamaster.com
Si vous ne trouvez pas l'article que vous desirez, consultez-nous a consulta@egamaster.com ou a www.egamaster.com

COD.		L (mm)	A (mm)	B (mm)	C (mm)	D (mm)	E (mm)	F (mm)			
60837	30-36		29	60	35	70			600	5	●
60838	32-36	300	30	65	36	70	12	13	650		
60839	34-36	310	33	70	37	75			700		
60840	36-41	340	37	75	42	85	14		750		
60841	41-46	370	41	80	43	90		14	900		
60842	46-50	400		90	50	100	15		1500	1	-
60843	50-55	450	48	100		110	16	15	1600		
60799	55-60	495		110	55	120	18	20	2150		
60766	65-70	580	65	140	70	140	23	23	3550		
60769	75-80	660	85	170	85	160	28	26	5600		

DIN 895

■ SET





■ MM

COD.	PCS.		COD. PCS.	(mm)
68585	8	90081	60802, 60805, 60809, 60814, 60817, 60820, 60826, 60828	8-9, 10-11, 12-13, 14-15, 16-17, 18-19, 21-23, 22-24
68586	12	90055	60800, 60802, 60805, 60809, 60814, 60817, 60820, 60824, 60826, 60830, 60831, 60835	6-7, 8-9, 10-11, 12-13, 14-15, 16-17, 18-19, 20-22, 21-23, 24-27, 25-28, 30-32

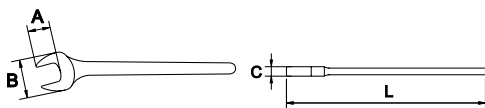
■ FIJA UNA BOCA / SINGLE ENDED OPEN JAW SPANNER / À FOURCHE SIMPLE / EINMAULSCHLÜSSEL / FISSE SEMPLICE / FIXA DE UMA BOCA / ОДНОРОЖКОВЫЙ КЛЮЧ

■ MM



COD.		L (mm)		A (mm)	B (mm)	C (mm)			
60844	8	90	5/16	7,0	17	3,8	15		
60845	9	100		9,5	20	3,9	18		
60846	10	105		11	22	4,5	20		
60847	11	110	7/16	12	23		23		
60848	12	125		13	25		27		
60849	13	130		14	28		37		
60850	14	140	9/16	15	29	6,0		10	
60851	15	150			32		42		
60852	16	155		16					
60853	17	160		17	34	6,5	60		●
60854	18	165		18	36				
60855	19	170	3/4	20	39	7,5	75		
60856	21	180	-		43		100		
60857	22	195	7/8	23	45	8,5	120		
60858	24	210			48	9,5	140		
66461	25	220		25	50		160		
60859	27	240	1.1/16	27	55	10	180		
60860	30	260	1.3/16	29	60		300		
60861	32	270	-	32	65	12	310		
60862	34	280	1.11/32	33	70	13	400	5	
60863	36	300	-	37			420		
60864	38	320	1.1/2	41	75	14			
60865	41	340	1.5/8	42	85		550		-
60866	46	370	1.13/16	44	90	15	800		
66466	48	380	-	46	95		900		
60867	50	390		50	100	16	1050		



COD.	AF mm	L (mm)	AF inch	A (mm)	B (mm)	C (mm)	g		
60868	55	440	-	55	110	17	1200	5	
60869	60	470	2.3/8		120		1550		
60870	65	500	2.9/16		130	18			
62984	70	550	2.3/4	60	140	19	2250		
62985	75	600			150	20	2850		
62986	80				160	21	3600		
62987	85	650		70	170	22	3500	1	
62988	90						4800		
62989	95	750		75	190	24	4600		
63848	100						7700		
63849	105	1000		105	220	29	8000		

DIN 894

■ SET

■ MM

COD.	PCS.		COD. PCS.	(mm)
68608	8	90081	60844, 60846, 60847, 60848, 60849, 60850, 60853, 60855	8, 10, 11, 12, 13, 14, 17, 19
68609	12	90083	60844, 60845, 60846, 60847, 60848, 60849, 60850, 60852, 60853, 60854, 60855, 60857	8, 9, 10, 11, 12, 13, 14, 16, 17, 18, 19, 22



LLAVES DE GOLPE SEGURIDAD TOTAL / TOTAL SAFETY SLOGGING WRENCHES / CLÉS À FRAPPER SÉCURITÉ TOTALE / SCHLAGRINGSCHLÜSSEL MIT SICHERUNG / CHIAVI A BATTERE SICUREZZA TOTALE / CHAVES DE LUNETA SÉRIE PANCADA DE SEGURANÇA TOTAL / КОЛЬЦЕВОЙ УДАРНЫЙ КЛЮЧ-ЗВЕЗДОЧКА С ПОДВЕСОМ

■ MM

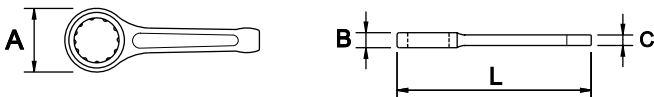

COD.	AF mm	L (mm)	A (mm)	B (mm)	C (mm)		Kg	
AD574257	22	155	38	13	8			
AD574267	23							
AD574277	24	165	42	14	8,5		0,2	
AD574287	25							
AD574297	26							
AD562957	27	175	46		9,5		0,3	
AD574307	28							
AD574317	29			16		89021	0,4	
AD562967	30	185	50					
AD574327	31							
AD574337	32		55		11		0,5	5
AD574347	33			18				
AD574357	34	210						
AD574367	35			19			0,6	
AD574377	36		60					
AD574387	37	220						
AD574397	38			20	12		0,7	
AD574407	41	225	65					
AD574417	42							
AD574427	45							
AD574437	46	240	75	22	13	89022	1	
AD574447	47							
AD574457	48							
AD574467	50	250	80	23	14		1,2	1
AD574477	52							



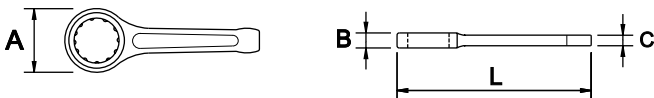

COD.	AF mm	L (mm)	A (mm)	B (mm)	C (mm)		Kg	
AD574487	54							
AD574497	55		85	24	14		1,4	
AD574507	56							
AD574517	58	270						
AD574527	59							
AD574537	60		90	26	15	89022	1,6	
AD574547	61							
AD574557	62							
AD574567	63							
AD574577	64	300	100	30	16		1,9	
AD562977	65							
AD574587	66							
AD574597	67							
AD574607	68							
AD574617	69	320	110	32	17		2,3	1
AD574627	70							
AD574047	71					89023		
AD574057	72							
AD574067	73							
AD574077	74	330	115	33	18		2,9	
AD574087	75							
AD585817	80	350	125	34	19		3,6	
AD585827	85	360	130	36	20		3,9	
AD585837	90	380	135	39	23	89016	5,0	
AD585847	95	390	145					
AD585857	100	410	150	43	25	89017	6,0	
AD585867	105	420	155				6,5	
AD585877	110	450	170	45	28	89018	8,0	
AD585887	115						9,5	

INCH



COD.	AF inch	L (mm)	A (mm)	B (mm)	C (mm)		Kg	
AD574657	7/8	155	38	13	8		0,2	
AD574667	15/16	165	42	14	9			
AD574677	1	175	46		10		0,3	
AD574687	1.1/16							
AD574697	1.1/8		50	16			0,4	
AD574707	1.3/16	185						
AD574717	1.1/4		55		11			
AD574727	1.5/16			18			0,5	5
AD574737	1.3/8	210		19				
AD574747	1.7/16		60					
AD574757	1.1/2	220						
AD574767	1.9/16							
AD574777	1.5/8	230	65	20	12		0,7	
AD574787	1.11/16							
AD574797	1.3/4							
AD574807	1.13/16	240	75	22	13			
AD574817	1.7/8						1	
AD574827	1.15/16							
AD574837	2	250	80	23				
AD574847	2.1/16				14			1
AD574857	2.1/8		85	24			1,4	
AD574867	2.3/16	270						
AD574877	2.1/4		90	26	15		1,6	
AD574887	2.5/16							



COD.		L (mm)	A (mm)	B (mm)	C (mm)		
AD574897	2.3/8	270	90	26	15	1,6	1
AD574907	2.7/16						
AD574917	2.1/2	300	100	28	16	2,3	
AD574927	2.9/16						
AD574937	2.5/8						
AD574947	2.11/16	320	110	32	17	2,5	
AD574957	2.3/4						

ACCESORIOS / ACCESSORIES / ACCESSOIRES / ERSATZTEILE / ACCESSORI / ACESSORIOS / ЗАПАСНЫЕ ЧАСТИ
MM

COD.	Descripción / Description / Description	Válido para / Valid for / Valable pour
89129		AD574257
89130		AD574267
89131		AD574277
89132		AD574287
89133		AD574297
89134		AD562957
89135		AD574307
89136		AD574317
89137		AD562967
89138		AD574327
89139		AD574337
89140		AD574347
89141		AD574357
89142		AD574367
89143		AD574377
89144		AD574387
89145		AD574397
89148		AD574407
89149		AD574417
89152		AD574427
89153		AD574437
89154		AD574447
89155		AD574457
89157		AD574467
89159		AD574477
89161		AD574487
89162	Set 5 pcs hilo tórico / Set of 5 o-ring cords / Jeu de 5 pcs corde	AD574497
89163		AD574507
89165		AD574517
89166		AD574527
89167		AD574537
89168		AD574547
89169		AD574557
89170		AD574567
89171		AD574577
89172		AD562977
89173	AD574587	
89174	AD574597	
89175	AD574607	
89176	AD574617	
89177	AD574627	
89178	AD574047	
89179	AD574057	
89180	AD574067	
89181	AD574077	
89182	AD574087	
89220	AD585817	
89221	AD585827	
89222	AD585837	
89223	AD585847	
89224	AD585857	
89225	AD585867	
89256	AD585877	
89257	AD585887	

 x5

INCH

COD.	Descripción / Description / Description	Válido para / Valid for / Valable pour
89187		AD574657
89188		AD574667
89189		AD574677
89190		AD574687
89191		AD574697
89192		AD574707
89193		AD574717
89194		AD574727
89195		AD574737
89197		AD574747
89198		AD574757
89199		AD574767
89200		AD574777
89201		AD574787
89202	Set 5 pcs hilo tórico / Set of 5 o-ring cords / Jeu de 5 pcs corde	AD574797
89203		AD574807
89204		AD574817
89205		AD574827
89206		AD574837
89207		AD574847
89208		AD574857
89209		AD574867
89211		AD574877
89212		AD574887
89213		AD574897
89214		AD574907
89215		AD574917
89216		AD574927
89217		AD574937
89218		AD574947
89219		AD574957

 x5

MM / INCH

COD.	Descripción / Description / Description
89021	Grillete / Shackle / Manille
89022	
89023	
89016	
89017	
89018	

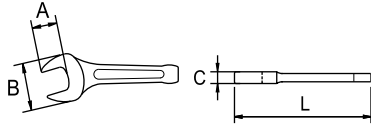

■ LLAVES DE GOLPE / SLOGGING WRENCHES / CLÉS À FRAPPER / SCHLAGSCHLÜSSEL / CHIAVI A PERCUSSIONE / CHAVES DE PANCADA / УДАРНЫЕ КЛЮЧИ
■ FIJA DE GOLPE / SLOGGING OPEN WRENCH / À FOURCHE À FRAPPER / SCHLAGMAULSCHLÜSSEL / FISSE AD IMPULSO / BOCA DE IMPACTO / УДАРНЫЙ РОЖКОВЫЙ КЛЮЧ
■ MM

COD.	AP mm	L (mm)	A (mm)	B (mm)	C (mm)	Kg		
67423	17	125	19	41		0,1		
67424	19							
67425	21				12			
67426	22	135	22	46		0,2		
60871	24	150	24	50			5	●
60903	26	175	27	60	15	0,4		
60872	27							
60873	30	190	30	65	16			
60874	32		32			0,6		
67427	34	200	34	70				
60875	36	210	36	75	17	0,7		
67428	38	220	38	80		0,8		
60876	41	230	41	90	18	0,9		
60877	46	250	46	100	20	1,5		
60878	50							
67563	52	280	50	110	21			
67435	54	305		117		2		
60879	55	300	55	120				
67436	56	305		117	23			
60880	60	320	60	130		3		
60927	65	340	65	140				
61283	67	335	67		28			
61284	68		68					
60928	70		70		29	5		
61285	71	370	71	160				
61286	72		72		30			
60929	75	380	75		29	6		
60930	80							
60931	85	400	85	175	32	7		
60932	90					10		
60933	95	450	95	195	36	11	1	-
60934	100							
60935	105	490	105		43	14		
60936	110			230				
60937	115	500	115		45			
60938	120							
67429	125		125	250		19		
67430	130	550			50			
67431	135		135	270				
67432	140							
67433	145	650	145	290	55	24		
67434	150		150					
57050	155	645	160	310	60	27		
57051	160							
57052	165	705	170	330		30		
57053	170				65			
57054	175	720	180	350		33		
57055	180							
57056	185	755	190	370		39		
57057	190				70			
57058	195	760	200	390		46		
57059	200					50		

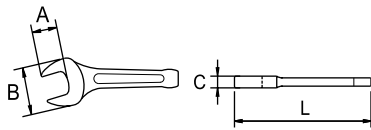

DIN 133

INCH

COD.	AF inch	L (mm)	A (mm)	B (mm)	C (mm)	Kg			
67437	3/4	125		41	7	0,1			
67438	7/8	135	12	47		0,2			
67439	15/16	150		50	8				
60966	1					0,4	5	•	
60967	1.1/16	165	14	60	9				
67440	1.1/8					0,5			
60968	1.3/16								
60969	1.1/4	190	16	70	10	0,6			
67441	1.5/16								
67442	1.3/8	210	17	75		0,7			
67443	1.7/16					0,8			
67444	1.1/2	220	18	80	12				
67445	1.9/16					0,9			
60970	1.5/8	230	19	90					
67446	1.11/16								
67447	1.3/4								
60971	1.13/16	250	20	100	13	1,2			
67448	1.7/8								
67449	1.15/16					1,4			
60972	2	280	21	110					
67450	2.1/16				14				
67451	2.1/8	310	23	120		1,8			
67452	2.3/16								
67453	2.1/4								
67454	2.5/16								
60973	2.3/8			130	15	2,1			
67455	2.7/16	320	24						
67456	2.1/2								
60974	2.9/16			135	16	2,9			
67457	2.5/8								
67458	2.11/16								
60975	2.3/4	330	26	140	17	3,6	1	-	
67459	2.13/16								
67460	2.7/8								
60976	2.15/16	340	28	150	18	4			
60977	3								
67461	3.1/16	360	29	160	19				
60978	3.1/8								
58093	3.3/16	200	85	174	18	5,5			
67462	3.1/4								
67463	3.5/16	360	29	160	19				
67464	3.3/8								
67465	3.7/16								
67466	3.1/2								
67467	3.9/16	400	33	185	22	7			
67468	3.5/8								
67469	3.11/16								
60979	3.3/4								
67470	3.13/16								
67471	3.7/8								
67472	3.15/16								
60980	4	430	40	200	24	11			
67473	4.1/16								
60981	4.1/8								
67474	4.3/16								



COD.	AP inch	L (mm)	A (mm)	B (mm)	C (mm)	Kg		
67475	4.1/4							
67476	4.5/16							
67477	4.3/8	500	45	240	25	14		
60982	4.1/2							
67478	4.9/16							
67479	4.5/8							
67480	4.11/16							
67481	4.3/4							
67482	4.13/16			250	27	16		
67483	4.7/8							
67484	4.15/16	550	50					
67485	5							
67486	5.1/4							
67487	5.5/16			270	30	18		
67488	5.3/8							
67489	5.1/2							
67490	5.3/4	650	55	290	32	24		
67491	6							
58075	6.1/8						1	-
58076	6.1/4	645	160	305	60	28		
58077	6.3/8							
58078	6.1/2							
58079	6.9/16	705	170	325		34		
58080	6.5/8							
58081	6.3/4				65			
58082	6.7/8							
58083	7	720	180	345		38		
58084	7.1/8							
58085	7.1/4							
58086	7.3/8	755	190	365		42		
58087	7.1/2							
58088	7.5/8				70			
58089	7.9/16							
58090	7.3/4	770	200	385		48		
58091	7.7/8							
58092	8							

DIN 133

ESTRELLA DE GOLPE / SLOGGING RING / POLYGONALE À FRAPPER / SCHLAG RINGSCHLÜSSEL / POLIGONALE AD IMPULSO / LUNETAS DE IMPACTO / УДАРНЫЙ КЛЮЧ ЗВЕЗДОЧКА

MM

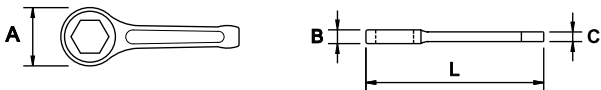

COD.	AP mm	L (mm)	A (mm)	B (mm)	C (mm)	Kg		
68927	17							
68928	19							
68929	22	155	38	13	8	0,2		
68930	24	165	42	14	9			
68931	27	175	46		10	0,3		
68932	30	185	50	16		0,4	5	•
68933	32		55		11	0,5		
68934	36	210	60	19		0,6		
68935	41	230	65	20	12	0,7		
68936	46	240	75	22	13	1		
68937	50	250	80	23		1,2		
68938	55		85	24	14	1,4		
68939	60	270	90	26	15	1,6	1	-
68940	65	300	100	30	16	1,9		
68941	70	320	105	32	17	2,3		



COD.	AP mm	L (mm)	A (mm)	B (mm)	C (mm)	Kg		
68942	75	330	115	33	18	2,9		
68943	80	350	125	34	19	3,6		
68944	85	360	130	36	20	3,9		
68945	90	380	135	39	23	4,8		
68946	100	410	148	43	25	5,8		
68947	110	450	170	45	28	8	1	-
68948	120	480	180	50	30	10		
68949	130	510	200	55	31	12		
68950	140	520	210					
68951	150	570	220	60	32	14		
68952	160	590	240		33	16		

DIN 7444

INCH

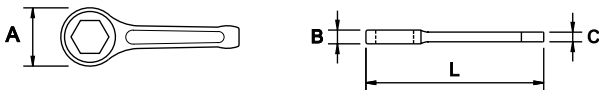

COD.	AP inch	L (mm)	A (mm)	B (mm)	C (mm)	Kg		
68687	5/8	145	32	12	7			
68614	3/4					0,2		
68615	7/8	155	38	13	8			
68616	15/16	165	42	14	9			
68617	1					0,3		
68618	1.1/16	175	46		10			
68619	1.1/8		50	16		0,4	5	•
68620	1.3/16	185						
68621	1.1/4		55		11			
68622	1.5/16			18		0,5		
68623	1.3/8	210		19				
68624	1.7/16		60					
68625	1.1/2	220						
68626	1.9/16			20	12	0,7		
68627	1.5/8	230	65					
68628	1.11/16							
68629	1.3/4							
68630	1.13/16	240	75	22	13			
68631	1.7/8					1		
68632	1.15/16	250	80	23				
68633	2							
68634	2.1/16				14			
68635	2.1/8		85	24		1,4		
68636	2.3/16							
68637	2.1/4	270						
68638	2.5/16							
68639	2.3/8		90	26	15	1,6		
68640	2.7/16						1	-
68641	2.1/2							
68642	2.9/16	300	100	30	16	2,3		
68643	2.5/8							
68644	2.11/16							
68645	2.3/4	320	110	32	17	2,5		
68646	2.13/16							
68647	2.7/8							
68648	2.15/16	330	115	33	18	3,2		
68649	3							
68650	3.1/16	350	125	34	19	3,6		
68651	3.1/8							
68652	3.1/4							
68653	3.5/16	360	130	36	20	3,9		



COD.	AP ^{inch}	L (mm)	A (mm)	B (mm)	C (mm)	Kg		
68654	3.3/8	360	130	36	20	3,9		
68655	3.1/2	380	135			4,8		
68656	3.9/16							
68657	3.5/8			39	23			
68658	3.11/16	390	140			5,2		
68659	3.3/4							
68660	3.13/16							
68661	3.7/8	410	150			5,8		
68662	3.15/16			43	25			
68663	4							
68664	4.1/16	420	155			6,5		
68665	4.1/8							
68666	4.3/16							
68667	4.1/4							
68668	4.5/16	450	160	45	28	8		
68669	4.3/8						1	-
68670	4.1/2							
68671	4.9/16		170			9,6		
68672	4.5/8							
68673	4.11/16							
68674	4.3/4	480	180	50	30	11		
68675	4.13/16							
68676	4.7/8							
68677	4.15/16							
68678	5							
68679	5.1/4		200	55	31			
68680	5.5/16	520				12		
68681	5.3/8							
68682	5.1/2		210					
68683	5.3/4	570		60	32	14		
68684	6	590	220			16		

DIN 7444

■ MM

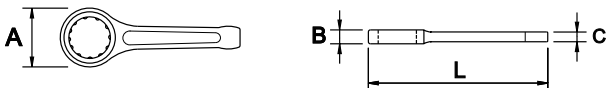

COD.	AP ^{mm}	L (mm)	A (mm)	B (mm)	C (mm)	Kg		
67310	17							
67311	18	145	32	12	7			
67312	19							
67313	20							
67314	21		38	13	8			
67315	22	155				0,2		
67316	23							
60881	24	165	42	14	8,5			
67317	25							
60904	26							
60882	27	175	46		9,5		5	●
67318	28					0,3		
67319	29			16				
60883	30	185	50			0,4		
67320	31							
60884	32		55		11			
67321	33							
67322	34	210		18		0,5		
67323	35							
60885	36		60	19				
67324	37	220		20	12	0,6		



COD.	AF mm	L (mm)	A (mm)	B (mm)	C (mm)	Kg		
67325	38	220	60			0,7		
67274	39	215	61	20	12	0,6		
60886	41	225	65				5	
60887	42					0,7		
67326	45							
60888	46	240	75	22	13			
67327	47					1		
67422	48							
60889	50	250	80	23				
67328	52				14	1,2		
67329	54							
60890	55		85					
67330	56			24		1,4		
67331	58							
67332	59	270						
60891	60		90		15			
67333	61			26		1,6		
67334	62							
67335	63							
67336	64	300	100		16			
60939	65			30		1,9		
67337	66							
67338	67							
67339	68							
67340	69	320	110	32	17	2,3		
60940	70							
67341	71							
67342	72							
67343	73							
67499	74							
60941	75	330	115	33	18	2,9		
67344	76							
67345	77							
67346	78							
67347	79	350	125	34	19	3,6	1	
60942	80							
67348	82							
67492	84	360	130	36	20	3,9		
60943	85							
67349	88	380	135					
60944	90			39	23	5		
67350	94	390	145					
60945	95							
67351	98							
60946	100	410	150			6		
67308	102			43	25			
60947	105					6,5		
67309	107	420	155			7,0		
67368	108							
60948	110	450	170	45	28	8,0		
60949	115					9,5		
60950	120	480	180	50	30	10		
67352	125							
67353	130	510	195	55	31	12		
67354	135							
67355	140	520	210					
67356	145							
67357	150	570	220	60	32	14		
67358	155							
67359	160	590	240		33	16		
67360	165							
67361	170	650	270	65	34	25		

COD.	AF mm	L (mm)	A (mm)	B (mm)	C (mm)	Kg		
67362	175	650	270	65	34	25		
67363	180							
67364	185	690	280	70		33	1	-
67365	190				35			
67366	195	710	300	75		36		
67367	200							

DIN 7444

INCH

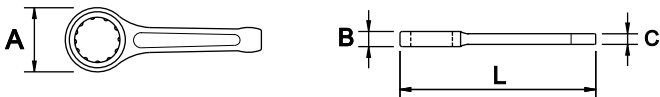

COD.	AF inch	L (mm)	A (mm)	B (mm)	C (mm)	Kg		
67369	1/2	100	24	9	5	0,1		
67370	3/4	145	32	12	7			
67371	7/8	155	38	13	8	0,2		
67372	15/16	165	42	14	9			
60983	1	175	46		10	0,3		
60984	1.1/16							
67373	1.1/8		50	16		0,4		
60985	1.3/16	185						
60986	1.1/4		55		11		5	•
67374	1.5/16			18		0,5		
61294	1.3/8	210		19				
67375	1.7/16		60					
61295	1.1/2	220						
61296	1.9/16			20	12	0,7		
60987	1.5/8	230	65	20	12			
67376	1.11/16							
67377	1.3/4							
60988	1.13/16	240	75	22	13			
67378	1.7/8					1		
67379	1.15/16	250	80	23				
60989	2							
67380	2.1/16				14			
67381	2.1/8		85	24		1,4		
67382	2.3/16							
67383	2.1/4	270						
67384	2.5/16		90	26	15	1,6		
60990	2.3/8							
67385	2.7/16							
67386	2.1/2							
60991	2.9/16	300	100	28	16	2,3		
67387	2.5/8							
67388	2.11/16							
60992	2.3/4	320	110	32	17	2,5	1	-
67389	2.13/16							
67390	2.7/8							
60993	2.15/16	330	115	33	18	3,2		
60994	3							
67391	3.1/16	350	125	34	19	3,6		
60995	3.1/8							
58071	3.3/16	355	124			3,6		
67392	3.1/4							
67393	3.5/16	360	130	36	20	3,9		
67394	3.3/8							
68570	3.7/16							
67395	3.1/2	380	135	39	23	4,8		
67396	3.9/16							



COD.	AF inch	L (mm)	A (mm)	B (mm)	C (mm)	Kg		
67397	3.5/8							
67398	3.11/16	390	140	39	23	5,2		
60996	3.3/4							
67399	3.13/16							
67400	3.7/8	410	150			5,8		
67401	3.15/16			43	25			
60997	4							
67402	4.1/16	420	155			6,5		
60998	4.1/8							
67403	4.3/16							
67404	4.1/4		160			8		
67405	4.5/16	450		45	28			
67406	4.3/8							
60999	4.1/2		170			9,6		
67407	4.9/16							
67408	4.5/8							
67409	4.11/16							
67410	4.3/4	480	180	50	30	11		
67411	4.13/16							
67412	4.7/8							
67413	4.15/16							
67414	5							
67415	5.1/4		200	55	31		1	-
67416	5.5/16	520				12		
67417	5.3/8		210					
67418	5.1/2			60				
67419	5.3/4	570			32	14		
67420	6	590	220			16		
57136	6.1/8	565				13,7		
57139	6.1/4							
58055	6.3/8	585	240	58	33	16		
58056	6.1/2							
58057	6.9/16							
58058	6.5/8							
58059	6.3/4	645	265	64	34	25		
58060	6.7/8							
58061	7							
58062	7.1/8							
58063	7.1/4	685	285	70		33		
58064	7.3/8							
58065	7.1/2				35			
58066	7.9/16							
58067	7.5/8							
58068	7.3/4	710	295	75		36		
58069	7.7/8							
58070	8							

DIN 7444

LLAVES ESTRELLA DE GOLPE DE PARED FINA / SLOGGING RING WRENCH THIN WALL / CLÉS POLYGAONALES À FRAPPER À PAROI FINE / SCHLAGRINGSCHLÜSSEL DUNNWANDIG / CHIAVE POLIGONALI IMPACT PARETE FINA / CHAVES LUNETA DE PANCADA DE PAREDE FINA / КЛЮЧ НАКИДНОЙ УДАРНЫЙ ТОНКОСТЕННЫЙ

■ MM

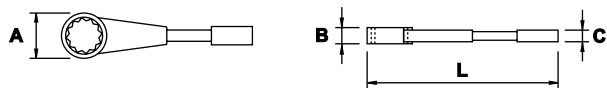

COD.	AF mm	L (mm)	A (mm)	B (mm)	C (mm)	Kg		
56300	27	250	43	16	17	0,6		
56301	30	256	47	18	19	0,75		
56302	32	260	49	19			5	•
56303	36	270	55	22	21	1,05		
56304	41	278	61	24	23	1,25		
56305	46	287	67	26	24	1,50		
56306	50	296	72	28	25	1,75		
56307	55	303	78	30	27	2		
56308	60	315	85	33	28	2,35		
56309	65	322	93	35	29	2,65		
56310	70	325	99	37	30	2,9		
56311	75	338	106	39	31	3,3		
56312	80	348	112	42	32	3,7		
56313	85	350	119	43		4	1	-
56314	90	353	126		33	4,25		
56315	95	358	133	44		4,6		
56316	100	366	139			4,9		
56317	105	375	147			6,5		
56318	110	382	157	45	34	7,2		
56319	115	390	163			8		
56320	120	405	174	47	35			

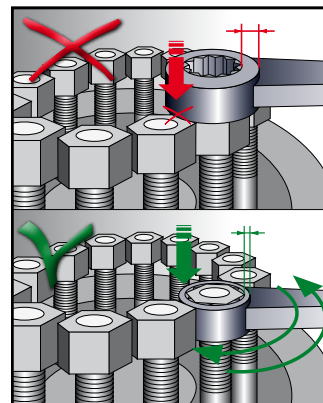

■ INCH



COD.	AF inch	L (mm)	A (mm)	B (mm)	C (mm)	Kg		
56321	1.1/16	250	43	16	17	0,6		
56322	1.1/4	260	49	19		0,75		
56323	1.7/16	270	55	22	21	1,05	5	•
56324	1.5/8	278	61	24	22.5	1,25		
56325	1.13/16	287	67	26	24	1,5		
56326	2	296	72	28	25	1,75		
56327	2.3/16	303	78	30	26.5	2		
56328	2.3/8	315	85	33	28	2,35		
56329	2.9/16	322	93	35	29	2,65		
56330	2.3/4	325	99	37	30	2,9	1	-
56331	2.15/16	338	106	39	31	3,3		
56332	3.1/8	348	112	42	32	3,7		
56333	3.1/2	353	126	44	33	4,25		
56334	3.7/8	366	139			4,9		

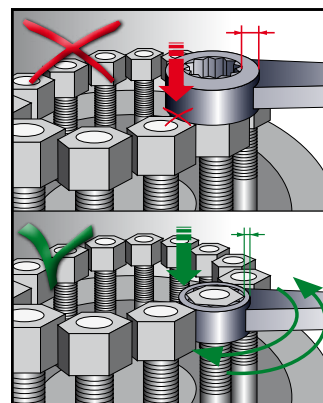

LLAVE ESTRELLA DE GOLPE CURVA / CURVED SLOGGING RING WRENCH / CLÉ POLYGONALE À FRAPPER COURBEE / ZUGSCHLAGRINGSCHLÜSSEL, GEBOGEN / POLIGONALE AD IMPULSO A CURVA / CHAVE LUNETA CURVA DE PANCADA / УДАРНЫЙ ИЗОГНУТЫЙ РОЖКОВЫЙ КЛЮЧ

MM

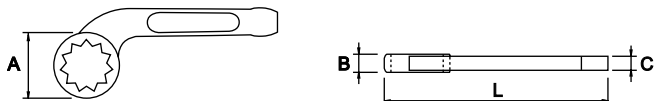

COD.	AF mm	L (mm)	A (mm)	B (mm)	C (mm)	g		
58360	19							
58361	20	160			8,5			
58362	21							
54950	22	140	42	14	9	250		
58363	23				8,5			
54951	24	160			9			
58364	25				8,5			
58365	26				9,5			
54952	27	175	46		10	330		
58366	28			16	9,5			
58367	29		54		10,5			
54953	30	190	55			515		
54954	32							
58368	34	210	58		11	630	1	
54955	36		60	19				
58369	38	225	64					
58370	40			20	12	870		
54956	41	230	65					
58371	42	225	64					
54957	46	240	75	22	13	1100		
54958	50	260	80	23		1300		
54959	55	270	85	24	14	1500		
54960	60	290	90	26	15	2000		
54961	65	300	100	30	16	2500		
54962	70	320	110	32	17	2800		
54963	75	330	115	33	18	3200		
58372	80	350	124	34	19	3900		



INCH

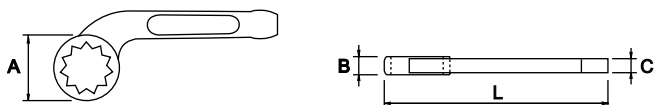

COD.	AF inch	L (mm)	A (mm)	B (mm)	C (mm)	g		
58376	3/4							
58377	7/8	160	42	14	8,5	250		
58378	15/16							
58379	1	175	46		9,5	380		
58380	1.1/8	190	54	16	10,5	500		
58381	1.1/4							
58382	1.3/8	210	58	19	11	620		
58383	1.1/2	225	64	20	12	865	1	
58384	1.5/8							
58385	1.3/4	240	73	22	13	1125		
58386	1.7/8							
58387	2	255	78	23	13,5	1250		
58388	2.1/4	285	92	25,5	15	2200		
58389	2.1/2	300	102	30	16	2600		
58390	2.3/4	320	108	31,5	17	2800		
58391	3	330	113	33	18	3150		



LLAVE FIJA GOLPE CURVA / CURVED OPEN END SLOGGING WRENCH / CLÉ À FOURCHE À FRAPPER COUDÉE / GEBOGEN SCHLAGMAULSCHLÜSSEL / CHIAVE FISSA A BATTERE CURVA / CHAVE DE BOCA DE PANCADA CURVA / УДАРНЫЙ ИЗОГНУТЫЙ ГАЕЧНЫЙ КЛЮЧ

■ MM

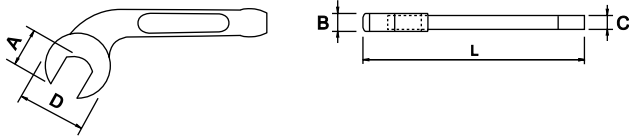

COD.	AF mm	L (mm)	A (mm)	B (mm)	C (mm)	D (mm)	g	
58396	19	140	19	10	7	40,5	140	
58397	20		22	11	7,5	46	175	
58398	21		24	12	8	50	200	
58399	22		25	15	9	57	400	
58400	23	150	24	12	8	50	200	
58401	24		27	15	9	57	400	
58402	25		30	16	10	66	750	
58403	26		32	17	11,5	75	750	
58404	27	175	27	15	9	57	400	1
58405	28		30	16	10	66	750	
58406	29		32	17	11,5	75	750	
58407	30		36	17	11,5	75	750	
58408	32	190	32	16	10	66	750	
58409	34		36	17	11,5	75	750	
58410	36		40	18,5	12	87	1130	
58411	38		41	18,5	12	87	1130	
58412	40	210	41	18,5	12	87	1130	
58413	41		46	20	13	98	1250	
58414	42		50	20,5	13,5	108	1700	
58415	46		55	23	14	117	2300	
58416	50	230	50	20,5	13,5	108	1700	
58417	55		60	23,5	15	128	2800	
58418	60		65	27,5	16	140	3600	
58419	65		70	28,5	17	155	4400	
58420	70	250	70	28,5	17	155	4400	
58421	75		75	29	18	160	4700	
58422	80		80	32	19	175	6100	



■ INCH

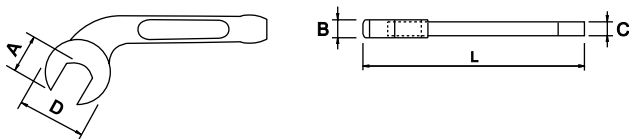

COD.	AF inch	L (mm)	A (mm)	B (mm)	C (mm)	D (mm)	g	
58430	3/4	140	19	10	7	40,5	140	
58431	7/8	150	22	11	7,5	46	170	
58432	15/16		24	12	8	50	200	
58433	1	175	27	15	9	57	500	
58434	1.1/8	190	30	16	10	66	550	
58435	1.1/4		32	16	10	66	550	
58436	1.3/8		36	17	11,5	75	800	
58437	1.1/2		40	18,5	12	87	1130	
58438	1.5/8	210	41	18,5	12	87	1130	1
58439	1.3/4		46	20	13	98	1250	
58440	1.7/8		50	20,5	13,5	108	1600	
58441	2		55	23,5	15	128	2800	
58442	2.1/4	315	60	23,5	15	128	3100	

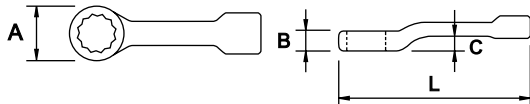

COD.	AF inch	L (mm)	A (mm)	B (mm)	C (mm)	D (mm)	g	
58443	2.1/2	335	65	27,5	16	140	3750	
58444	2.3/4	370	70	28,5	17	155	4400	1
58445	3	375	75	29	18	160	4600	

ESTRELLA DE GOLPE ACODADA / OFFSET SLOGGING RING / CLÉ POLYGONALE À FRAPPER CONTRE-COUDÉE / SCHLAGRINGSCHLÜSSEL GEKRÖPFT / CHIAVE A BATTERE POLIGONALE / LUNETTA INCLINADA DE PANCADA / КЛЮЧ НАКИДНОЙ УДАРНЫЙ
MM

COD.	AF mm	L (mm)	A (mm)	B (mm)	C (mm)	Kg		
55000	22	240	42	18	23	0,9		
55001	24							
55002	27	270	50	20	26	1,2		
55003	30	280	55	22	28	1,4		
55004	32	290	55	23	29	1,6	5	•
54998	34		62					
55005	36	300	65	25	31	1,8		
55006	38							
55007	41	320	70	26	32	2		
55008	46	340	70	27	34	2,6		
55009	50	350	80	32	38	3		
55010	55	360	85	33	39	3,9		
55011	60	380	90	35	41	4,0		
55012	65	390	95	38	44	4,0		
55013	70	400	105	41	47	5,0		
55014	75	420	110	43	49	5,5		
55015	80	440	125	45	50	7,0		
55016	85	460	125	45	50	7,5		
55017	90							
55018	95	480	140	47	55	9,0		
55019	100							
55020	105	520	155	49		11		
55021	110							
55022	115	550	170	50	60	12		
55023	120							
55024	125	590	180	55	64	14		
55025	130							
55026	135	620	200	60	70	16		
54942	140							
54943	145	650	215	60		22		
54944	150							
54945	155	680	235	64	72	28		

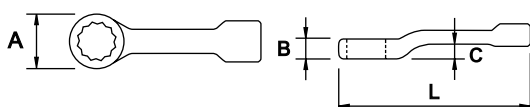
INCH

COD.	AF inch	L (mm)	A (mm)	B (mm)	C (mm)	Kg		
55027	7/8							
55028	15/16	240	42	18	23	0,9		
55029	1							
55030	1.1/16	270	50	20	26	1,2	5	•
55031	1.1/8	280	55	22	28	1,4		
55032	1.3/16							



COD.	AF inch	L (mm)	A (mm)	B (mm)	C (mm)	Kg		
55033	1.1/4							
55034	1.5/16	290	55	23	29	1,6		
55035	1.3/8						5	●
55036	1.7/16	300	65	25	31	1,8		
55037	1.1/2							
55038	1.9/16							
55039	1.5/8	320		26	32	2		
55040	1.11/16		70					
55041	1.3/4							
55042	1.13/16	340		27	34	2,6		
55043	1.7/8							
55044	1.15/16							
55045	2	350	80	32	38	3		
55046	2.1/16							
55047	2.1/8	360	85	33	39	3,9		
55048	2.3/16							
55049	2.1/4							
55050	2.5/16							
55051	2.3/8	380	90	35	41	4,1		
55052	2.7/16							
55053	2.1/2							
55054	2.9/16	390	95	38	44	4,2		
55055	2.5/8							
55056	2.11/16							
55057	2.3/4	400	105	41	47	5,1		
55058	2.13/16							
55059	2.7/8							
55060	2.15/16	420	110	43	49	5,5		
55061	3							
55062	3.1/16							
55063	3.1/8	440				6,9		
55064	3.1/4		125	45	50			
55065	3.5/16	460				7,3		
55066	3.3/8							
55067	3.1/2							
55068	3.9/16							
55069	3.5/8	480	140	47		8,8		
55070	3.11/16							
55071	3.3/4							
55072	3.13/16				55			
55073	3.7/8							
55074	3.15/16							
55075	4		155	49		10,9		
55076	4.1/16	520						
55077	4.1/8							
55078	4.3/16							
55079	4.1/4							
55080	4.5/16							
55081	4.3/8		170	50	60	12		
55082	4.1/2	550						
55083	4.9/16							
55084	4.5/8							
55085	4.11/16							
55086	4.3/4							
55087	4.13/16	590	180	55	64	14		
55088	4.7/8							
55089	4.15/16							
55090	5							
55091	5.1/4	620	200	60	70	16		
55092	5.1/16							

LLAVE ESTRELLA ACODADA PARA EXTENSIÓN / OFFSET RING SPANNER FOR EXTENSION / CLÉ POLYGONALE CONTRE COUDÉE À RALLONGE / RINGSCHLÜSSEL FÜR VERLÄNGERUNG / CHIAVE POLIGONALE PER ESTENSIONE / CHAVE INGLESA DESLOCADA DO ANEL PARA A EXTENSÃO / ИЗОГНУТАЯ ЗВЕЗДОЧКА ДЛЯ УДЛИНИТЕЛЯ

MM

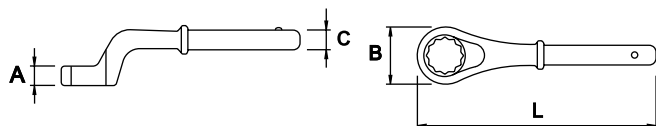

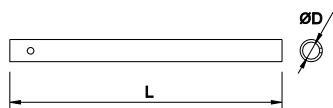

COD.	AF mm	L (mm)	A (mm)	B (mm)	C (mm)	g	
66562	21					400	
66563	22	180		38	20		
65888	24		17			390	
65889	27	190		42	18	420	
65890	30	200		48		500	
65891	32	230	18	49		750	
65892	36	240	20	55		800	
65893	38				21		
65894	41	260	21	60		950	
65982	42						
65895	46	280	23	70		1150	
65983	48						
65896	50	290	25	75	24	1350	1
65984	52						
65897	55	300	28	80		1450	
65898	60	340	31	90		2150	
65899	65	350	33	100		2500	
65900	70	360	36	105		2850	
65901	75	370	38	110		2050	
65902	80	380	41	125	29	3750	
65903	85					3550	
65904	90	410		140		5150	
65905	95		45			4900	
65906	100	420		150		5000	
65907	105					4900	



EXTENSIÓN PARA LLAVE ESTRELLA ACODADA / EXTENSION FOR OFFSET RING SPANNER / RALLONGE DE CLÉ POLYGONALE CONTRE-COUDÉE / VERLÄNGERUNG FÜR RINGSCHLÜSSEL / ESTENSIONE PER CHIAVI POLIGONALI / EXTENSÃO PA CHAVE LUNETA CURVA / УДЛИНИТЕЛЬ ДЛЯ КЛЮЧА ИЗОГНУТАЯ ЗВЕЗДОЧКА

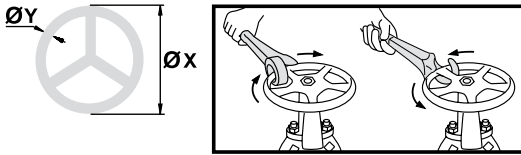

COD.	AF mm	O.D. mm	L (mm)	g	
65909	24-30	18	460	750	
65910	32-41	21	600	1150	1
65911	46-55	24	750	2750	
65912	60-105	29	850	2850	



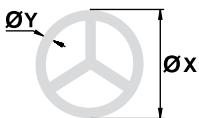

■ LLAVES PARA VÁLVULAS / VALVE WRENCHES / CLÉS POUR VALVES / VENTILSCHLÜSSEL / CHIAVI PER VALVOLE / CHAVES PARA VÁLVULAS / КЛАПАННЫЕ КЛЮЧИ
■ LLAVE DE VÁLVULA / VALVE WRENCH / CLÉ POUR VALVE / VENTILSCHLÜSSEL / CHIAVE A VALVOLA / CHAVE DE VÁLVULA / КЛАПАННЫЙ КЛЮЧ
■ UNIVERSAL / UNIVERSAL / UNIVERSEL / UNIVERSELL / UNIVERSALE / UNIVERSAL / УНИВЕРСАЛЬНЫЙ

COD.	L (mm)	Ø x (mm)	Ø x (inch)	Ø y (mm)		
62803	215	50-175	2-7	≤ 12	0,2	
62804	400	200-375	8-15	≤ 24	1,3	
62805	490	400-500	16-20	≤ 30	1,7	
62807	500	150-425	6-17	≤ 40	1,5	1
54972	550	125-250	5-10	≤ 35	1,4	
62806	800				2	
62812	1200	400-500	16-20	≤ 30	3	-

■ ESPECIAL / SPECIAL / SPÉCIAL / SPEZIELL / SPECIALE / ESPECIAL / СПЕЦИАЛЬНЫЙ
■ MM

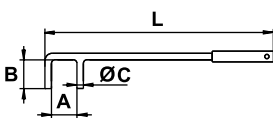
COD.	L (mm)	Ø x (mm)	Ø y (mm)		
51623	250	50-175	≤ 19	0,2	
51624	370	200-380	≤ 25	0,65	
51625	500	405-510	≤ 40	2,0	1
51626	800		≤ 60	3,5	



■ GANCHO GIRADOR DE VÁLVULAS / VALVE WHEEL HOOK / FIXATION GIRATOIRE DE VALVE / VENTILHAKEN / GANCIO GIREVOLE PER VALVOLE / GANCHO DE RODA VÁLVULAS / КЛЮЧ ДЛЯ ОТКРЫТИЯ КЛАПАНОВ
■ MM





COD.	L (mm)	A (mm)	B (mm)	Ø C (mm)		
54974	300	35	33	17	0,45	
54975	350	45	40		0,5	
54976	400	50	45		0,8	
54977	450	55	50		1	
54978	500	60	55		1,2	
54979	550	65	60	18	1,4	
54980	600	70	65		1,5	
54981	650	75	70		1,6	1
54982	700	80	70			
54983	750	85	75		2,3	
54984	800	90	85		2,4	
54985	850	95	85	20	2,5	
54986	900	90	90		2,6	
54987	950	100	95		2,8	
54988	1000				2,9	
54989	1200	105	100	25	5,5	

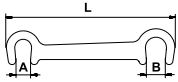

■ LLAVE EN "C" DOBLE / DOUBLE C WRENCH / CLÉ EN DOUBLE C / DOPPEL C SCHLÜSSEL / CHIAVE DOPPIA A C / CHAVE EM C DUPLA / ДВОЙНОЙ С-ОБРАЗНЫЙ КЛЮЧ

■ MM





COD.	L (mm)	A (mm)	B (mm)				
54992	200	14	18	14	18	0,4	
54993	250	17	25	17	25	0,6	1
54994	450	25	34	25	34	2,3	

■ LLAVE EN "C" / C WRENCH / CLÉ EN C / C SCHLÜSSEL / CHIAVE A C / CHAVE EM C / С-ОБРАЗНЫЙ КЛЮЧ

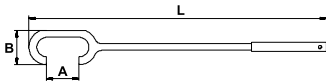
■ MM





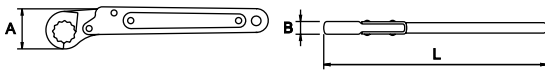

COD.	L (mm)	A (mm)	B (mm)		
54997	450	40	55	1	1

■ LLAVE DE CARRACA PARA RACORES / RATCHETING RING WRENCH / CLÉ À TUYAUTER À CLIQUET / KNARRENROHR SCHLÜSSEL / CHIAVE A CRICCO PER RACCORDI / CHAVE LUNETAS ABERTA COM ROQUETE / КЛЮЧ ЗВЕЗДОЧКА С ТРЕЩЕТКОЙ

■ MM



COD.		L (mm)	A (mm)	B (mm)			
65089	10				80		
65090	11				85		
65091	12	135	24	7,0			
65092	13				90		
65093	14						
65095	17		30		140	6	
65096	19	185	32	8,0	180		
65098	22	230	39	11	230		
65099	24						
65100	27	320	49	13	320		
65102	32		50	18			



■ SET

■ MM

COD.	PCS.		COD. PCS.	(mm)
68582	10	90058	65089, 65090, 65091, 65092, 65093, 65095, 65096, 65098, 65099, 65100	10, 11, 12, 13, 14, 17, 19, 22, 24, 27

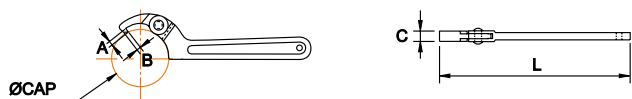

LLAVES DE GANCHO / HOOK WRENCHES / CLÉS À ERGOT / HAKENSCHLÜSSEL / CHIAVI A SETTORE / CHAVES DE GANCHO / СЕРПОВИДНЫЕ КРЮК- КЛЮЧИ
LLAVE DE GANCHO ARTICULADA / ADJUSTABLE HOOK SPANNER / CLÉ À ERGOT ARTICULEE / ZANGE MIT VERSTELLBARE BACKE / CHIAVE A SETTORE REGOLABILE / CHAVE DE GANCHO ARTICULADA / РУГУЛИРУЕМЫЙ КЛЮЧ КРЮК

COD.	L (mm)	CAP. Ø (mm)	CAP. Ø (inch)	A (mm)	B (mm)	C (mm)	g		
67981	160	19-50	3/4-2	4,0	3,5	9	110		
67982	205	32-75	1.1/4-3			11	225	6	•
67983	290	50-120	2-4.3/4	4,5	4,0	12	450		
67984	310	115-170	4.1/2-6.3/4	5,0	4,5	13	580		

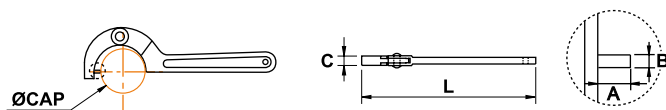
LLAVE DE GANCHO CON PIN ARTICULADA / ADJUSTABLE HOOK SPANNER WITH PIN / CLÉ À ERGOT ARTICULÉE AVEC CROCHET / VERSTELLBARE HAKENSCHLÜSSEL MIT PIN / CHIAVE A SETTORE ARTICOLATA CON PIN / CHAVES DE UNHA ARTICULADA COM PIN / КЛЮЧ-КРЮК С ШАРНИРОМ

COD.	L (mm)	CAP. Ø (mm)	CAP. Ø (inch)	A (mm)	B (mm)	C (mm)	g		
58120	170	15-35	19/32-1.3/8	3	3	5,5	100		
58121	200	35-50	1.3/8-2	4,3	4	7	180	10	
58122	280	50-80	2-3.3/4	5	6,2	8	380		•
58123	345	80-120	3.3/4-4.11/16	6			660		
58124	490	120-180	4.11/16-5.7/8	7,4	7,8	11	1440	5	

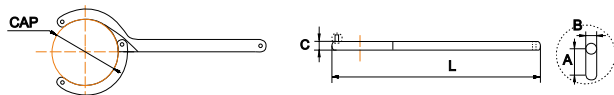

COD.	L (mm)	CAP. Ø (mm)	A (mm)	B (mm)	C (mm)	Kg		
54966	150	18-40	5	4	8	0,1		
54967	220	40-80	7	5	10	0,3		
54968	300	80-125	8	6	12	0,6	6	•
54969	410	125-200	10	8	14	1,6		



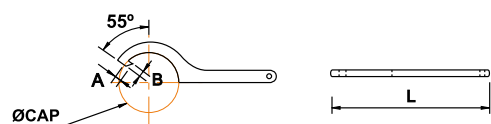

PIN DE RECAMBIO / SPARE PINS / CROCHET DE RECHANGE / ERSATZSTIFTE / PIN DI RICAMBIO / PINO DE SUBSTITUIÇÃO / ЗАПАСНОЙ ШТИФТ

COD.	A (mm)	Ø B (mm)	Válido para / Valid for / Valable pour
86890	3	3	58120
86891	4,3	4	58121
86892	5	6,2	58122
86893	6		58123
86894	7,4	7,8	58124



LLAVE DE GANCHO / HOOK SPANNER / CLÉ À ERGOT / ECKZANGE / CHIAVE A SETTORE / CHAVE DE GANCHO / КЛЮЧ КРЮК





COD.	L (mm)	CAP. Ø (mm)	CAP. Ø (inch)	A (mm)	B (mm)	g		
68283		12-14	1/2-9/16	1,8	1,8	16		
68284	110	16-20	5/8-25/32	2,3	2	20		
68285		25-28	1-1.1/8		2,3	40	6	•
68286	120	30-32	1.3/16- 1.1/4	2,5	2,5	60		

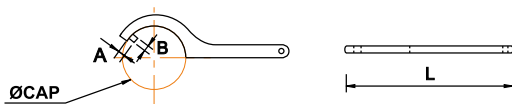

COD.	L (mm)	CAP. Ø (mm)	CAP. Ø (inch)	A (mm)	B (mm)			
68287	150	34-36	1.5/16-1.13/32	2,5	3	90		
68288		40-42	1.9/16-1.21/32			100		
68289	180	45-50	1.3/4-2	3	3,5	150		
68290		52-55	2.1/16-2.3/16			160		
68291	210	58-62	2.9/32-2.7/16	3,5	4	210		
68292		68-75	2.11/16-3			250		
68293	240	80-90	3.1/8-3.1/2			370		
68295		95-100	3.3/4-4			410		
68296	280	110-115	4.5/16-4.9/16	4	5	700	6	•
68297		120-130	4.11/16-5.1/8			750		
68298	320	135-145	5.5/16-5.3/4	6		1050		
68299		150-165	5.7/8-6.1/2			1150		
57640	380	180-195	7.1/8-7.5/8	14	6	1800		
57641		205-220	8.1/8-8.5/8			1900		
57642	460	230-245	9.1/8-9.5/8		8	3530		
57643		260-270	10.1/4-10.5/8	16		3600		
57644	550	280-300	11.1/8-11.3/4		10	5430		

DIN 1810





LLAVE DE GANCHO CON PIN / HOOK SPANNER WITH PIN / CLÉ À ERGOT AVEC CROCHET / HAKENSCHLÜSSEL MIT PIN / CHIAVE A SETTORE CON PIN / CHAVES DE UNHA COM PIN / КЛЮЧ-КРЮК

COD.	L (mm)	CAP. Ø (mm)	CAP. Ø (inch)	A (mm)	B (mm)			
58100	110	16-18	5/8-11/16	2,2	2,5	25	20	
58101		20-22	25/32-7/8					
58102	135	25-28	1-1.1/8	3	3	50		
58103		30-32	1.3/16-1.1/4					
58104	170	34-36	1.5/16-1.13/32	3,5	4	80	10	
58105		40-42	1.9/16-1.21/32					
58106	205	45-50	1.3/4-2	4	5	180		
58107		52-55	2.1/16-2.3/16					
58108	240	58-62	2.9/32-2.7/16	5	6	280	25	•
58109		68-75	2.11/16-3					
58110	280	80-90	3.1/8-3.1/2	6	6	435	15	
58111		95-100	3.3/4-4					
58112	335	110-115	4.5/16-4.9/16		8	800	10	
58113		120-130	4.11/16-5.1/8					
58114	385	135-145	5.5/16-5.3/4	8		1250		
58115		155-165	5.15/16-6.1/2				5	
58116	465	180-195	7-7.11/16		10	2100		
58117		205-220	8-8.11/16					

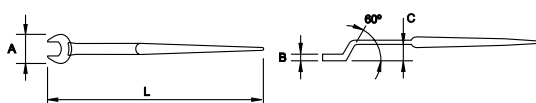
LLAVES PARA ESTRUCTURA / PODGING WRENCHES / CLÉS POUR STRUCTURE MÉTALLIQUE / SCHLÜSSEL FÜR DIE METALLSTRUKTUR / CHIAVI PER PONTEGGI / CHAVES DE ESTRUTURA / КЛЮЧИ ДЛЯ СТРОИТЕЛЬНЫХ ЛЕСОВ
LLAVE FIJA ACODADA PARA ESTRUCTURA / OFFSET OPEN END STRUCTURAL WRENCH / CLÉ À FOURCHE CONTRE-COUDÉE POUR STRUCTURE MÉTALLIQUE / MAULSCHLÜSSEL GEKROFFT MIT DORN / CHIAVE FISSA PER PONTEGGI / CHAVE BOCA INCLINADA PARA ESTRUTURA / КЛЮЧ ГАЕЧНЫЙ ОДНОСТОРОННИЙ ВИЛКОБРАЗНЫЙ СТРОИТЕЛЬНЫЙ

MM



COD.		L (mm)	A (mm)	B (mm)	C (mm)			
64912	17	350	24	7,5	24	210	1	•
64913	19		40	9		300		

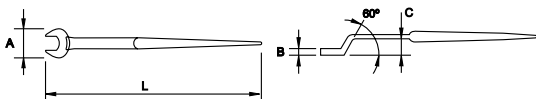

COD.	AP mm	L (mm)	A (mm)	B (mm)	C (mm)	g		
65781	21					400		
64914	22	350	46		24	410		
58425	23			11				
64915	24	370	49		28	450		●
64916	27		55			600		
64917	30			13				
64918	32	400	65		32	800		
64919	36	430	70	14	36	900	1	
58426	38							
64920	41	470	80	15	41	1200		
58427	45							
64921	46	500	90	16	46	1500		
58428	47							
64922	50	550	100	17	48	1800		
64923	55		110	18	50	2000		
58429	70	600	140	24	55	4400		

INCH

COD.	AP inch	L (mm)	A (mm)	B (mm)	C (mm)	g		
64924	3/4	350	40	9	24	300		
64925	7/8		46			410		
64926	15/16			11				
64927	1	370	49		28	450		●
64928	1.1/16							
64929	1.1/8							
64930	1.3/16	400		13	32	750		
64931	1.1/4		65					
64932	1.5/16							
64933	1.3/8	430		14	36	900		
64934	1.7/16							
64935	1.1/2						1	
64936	1.9/16	470	80	15	41	1200		
64937	1.5/8							
64938	1.11/16							
64939	1.3/4	500	90	16	46	1500		
64940	1.13/16							
64941	1.7/8							
64942	1.15/16	550	100	17	48	1800		
64943	2		110	18	50	2000		
64944	2.1/16							
64945	2.1/8							
64946	2.3/16							

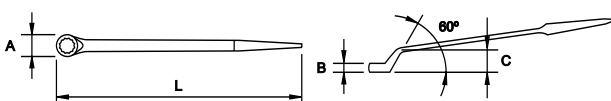
LLAVE ESTRELLA ACODADA PARA ESTRUCTURA / OFFSET RING STRUCTURAL WRENCH / CLÉ POLYGALE CONTRE-COUDÉE POUR STRUCTURE MÉTALLIQUE / RINGSCHLÜSSEL GEKRÖPFT MIT DORN / CHIAVE POLIGONALE PER PONTEGGI / CHAVE LUNETAS INCLINADA PARA ESTRUTURA / КЛЮЧ НАКИДНОЙ ОДНОСТОРОННИЙ ВИЛКООБРАЗНЫЙ СТРОИТЕЛЬНЫЙ
MM

COD.	AP mm	L (mm)	A (mm)	B (mm)	C (mm)	Kg		
64947	14	270	24	10	23	0,2	1	●



08

LLAVES
WRENCHES
CLÉS
SCHLÜSSEL
CHIAVI
CHAVES
КЛЮЧИ



COD.	AF mm	L (mm)	A (mm)	B (mm)	C (mm)	Kg		
64948	17	310	28	11	27	0,2		
64949	19	330	32	12	31			
64950	22	350	35	13	34	0,3		
64951	24	370	38	14	37	0,4		
64952	27	400	42	16	43	0,6		
64953	30	430	50	19	48	0,9		
64954	32	460	55	20	55	1,1		
64955	36	490	65	22	60	1,5		
64956	41	500	70	26	75	2,1		
64957	46	550	85	28	80	2,5	1	
64958	50	600	90	30	70	2,7		
64959	55	650	110	34	75	3,5		
64960	60	700	125	36	75	4,0		
64961	65	750	135	37	80	5,0		
64962	70		140	41		6,0		
64963	75		145	42		7,0		
64964	80		160	43				
64965	85							
64966	90							
64967	95							
64968	100							
64969	110							

INCH

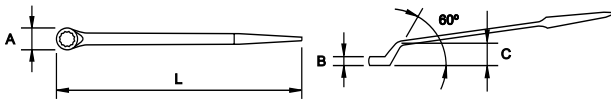

COD.	AF inch	L (mm)	A (mm)	B (mm)	C (mm)	Kg		
64970	3/4	330	32	12	31	0,2		
64971	7/8	350	35	13	34	0,3		
64972	15/16	370	38	14	37	0,4		
64973	1	400	42	16	43	0,6		
64974	1.1/16	430	50	19	48	0,9		
64975	1.1/8	460	55	20	55	1,1		
64976	1.3/16	490	65	22	60	1,5		
64977	1.1/4	500	70	26	75	2,1		
64978	1.5/16	550	85	28	80	2,5	1	
64979	1.3/8	600	90	30	70	2,7		
64980	1.7/16	650	105	30	70	2,7		
64981	1.1/2		128	35	72,5	4		
64982	1.9/16							
64983	1.5/8							
64984	1.11/16							
64985	1.3/4							
64986	1.13/16							
64987	1.7/8							
64988	1.15/16							
64989	2							
64990	2.1/16							
64991	2.1/8							
64992	2.3/16							
64993	2.1/4							
64994	2.5/16							
64995	2.3/8							
64996	2.7/16							
64997	2.1/2							
64998	2.9/16							
64999	2.5/8							
68126	3.1/8							



COD.	AF inch	L (mm)	A (mm)	B (mm)	C (mm)	Kg		
68127	3.7/8	650	152	40	75	5,8	1	-

LLAVE AJUSTABLE PARA ESTRUCTURA / ADJUSTABLE STRUCTURAL WRENCH / CLÉ À MOLETTE POUR STRUCTURE MÉTALLIQUE / VERSTELLBARE ROLLABELSCHLÜSSEL MIT DORN / CHIAVE REOLABILE PER PONTEGGI / CHAVE AJUSTÁVEL PARA ESTRUTURA / КЛЮЧ РАЗВОДНОЙ СТРОИТЕЛЬНЫЙ

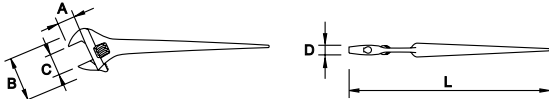

COD.	L (inch)	L (mm)	A (mm)	B (mm)	C (mm)	D (mm)	g		
61137	16	400	35	85	42	17	1100	1	•



LLAVE DE CARRACA PARA ESTRUCTURA METÁLICA / PODGING WRENCH / CLIQUET RÉVERSIBLE / STAHLBAUKNARRE / CHIAVE A CRICCO PER COSTRUZIONE / CHAVE DE ROQUETE PARA ESTRUTURA METÁLICA / ГОЛОВКА С ТРЕЩЕТКОЙ

MM

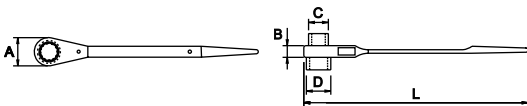

COD.	AF mm	L (mm)	A (mm)	B (mm)	C (mm)	D (mm)	g		
65916	10-13		28	15	15	18	170		
57545	12-14	240	32	16	17	20	240		
65908	13-17	280	41	17	19	24	310		
65076	17-19		43		24	27			
65917	19-21	320		19	26	28	480		
65077	19-22		50		29				
65078	19-24			20	28	33	650	6	•
57546	22-24	370			31	34	750		
57547	24-27		52		34	37			
65079	24-30			21	32	41	950		
65080	27-32	420	60		37	43			
57548	30-32			22	40	44	1000		
57549	32-36	450	79	26	46	51	2000		
65081	36-41			27	49	57			



LLAVE ESTRELLA DE CARRACA PLANA / DOUBLE RATCHET WRENCH / CLÉ POLYGONALE À CLIQUET / DOPPELKNARRE FLACH / CHIAVE A CRICCO / CHAVE LUNETA PLANA COM ROQUETE / ДВОЙНАЯ ТРЕЩЕТКА ЗВЕЗДОЧКА

MM

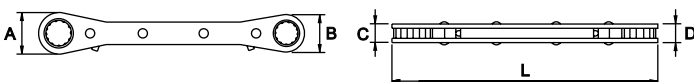

COD.	AF mm	L (mm)	A (mm)	B (mm)	C (mm)	D (mm)	g		
65107	8-10	150	18	17	9,0	9,0	90	6	
65108	10-11	170	22	19	9,0		120		
65109	12-13	180	26	21	9,5	9,5	140		
65110	14-15	210	33	30	10		200	10	•
65111	14-17			33		10	210		
65112	19-21	230	40	37	11	10	260		

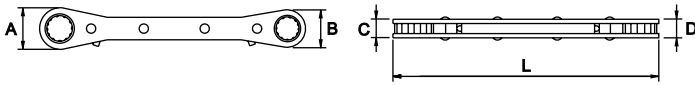

INCH

COD.	AF inch	L (mm)	A (mm)	B (mm)	C (mm)	D (mm)	g	Icon 1	Icon 2
65113	1/4-5/16	150	18	18	8,5	8,5	60		6
65114	3/8-7/16	175	24	20	9,0		85		
65115	1/2-9/16	180	29	24	10	9,5	140		•
65116	5/8-11/16	210	36	33		10	200		10
65117	3/4-7/8		40	37	11	12	260		

SET
MM

COD.	PCS.	Icon 1	COD. PCS.	(mm)
68610	6	90056	65107, 65108, 65109, 65110, 65111, 65112	8-10, 10-11, 12-13, 14-15, 14-17, 19-21

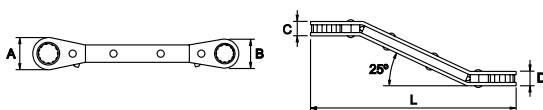

INCH

COD.	PCS.	Icon 1	COD. PCS.	(inch)
68611	5	90056	65113, 65114, 65115, 65116, 65117	1/4-5/16, 3/8-7/16, 1/2-9/16, 5/8-11/16, 3/4-7/8

LLAVE ESTRELLA DE CARRACA ACODADA / OFFSET DOUBLE RATCHET WRENCH / CLÉ POLYGONALE CONTRE-COUEE À CLIQUET / DOPPELKNARRE ABGEWINKELT / CHIAVE A CRICCO A CONTROGOMITO / CHAVE LUNETEA INCLINADA COM ROQUETE / ДВОЙНАЯ ТРЕЩЕТКА ЗВЕЗДОЧКА ИЗОГНУТАЯ
MM

COD.	AF mm	L (mm)	A (mm)	B (mm)	C (mm)	D (mm)	g	Icon 1	Icon 2
65118	8-10	150	20	18	9,5	9,0	85		
65119	10-11	175	25	21		9,5	120	6	
65120	12-13	180	29	24	10	10	140		•
65121	14-15	210	36	33		10	200		
65122	14-17		40			10	210	8	
65123	19-21	230	41	37	11	10	260		

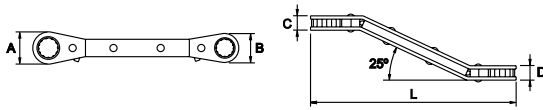

INCH

COD.	AF inch	L (mm)	A (mm)	B (mm)	C (mm)	D (mm)	g	Icon 1	Icon 2
65124	1/4-5/16	150	20	17	9,5	8,5	60	6	●
65125	3/8-7/16	175	23	20		9,0	85		
65126	1/2-9/16	180	30	27	10	9,5	140	8	●
65127	5/8-11/16	210	36	33		200			
65128	3/4-7/8		40	37		260			

SET
MM

COD.	PCS.	Icon 1	COD. PCS.	(mm)
68612	6	90056	65118, 65119, 65120, 65121, 65122, 65123	8-10, 10-11, 12-13, 14-15, 14-17, 19-21

INCH

COD.	PCS.	Icon 1	COD. PCS.	(inch)
68613	5	90056	65124, 65125, 65126, 65127, 65128	1/4-5/16, 3/8-7/16, 1/2-9/16, 5/8-11/16, 3/4-7/8

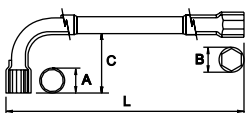
LLAVES DE PIPA ABIERTAS / ANGLED OPEN SOCKETS / CLÉS À PIPE DEBOUCHEES / PFEIFENKOPFSCHLÜSSEL / CHIAVI A PIPA APERTE / DE CACHIMBO ABERTAS / КЛЮЧ С ИЗОГНУТЫМИ ГОЛОВКАМИ
MM

COD.	AF mm	AF inch	L (mm)	A (mm)	B (mm)	C (mm)	g	Icon 1	Icon 2	Icon 3
61870	6	-	110	11	11	18	50	6	●	A
61871	7	-	115	12	12	21				
61872	8	5/16 *	120	13	13	22	60			
61873	9	-	125	14	14	22	70			
61874	10	25/64 *	130	16	16	26	100			
61875	11	7/16 *	135	17	17	26	140			
61876	12	5/32 *	145	18	18	27	160			
61877	13	-	150	19	19	30	170			
61878	14	35/64 *	160	21	21	33				
61879	15	-	175	22	22	35	230			
61880	16	-	185	24	24	39				
61881	17	-	200	25	25	39	290			



A Cromado pulido espejo / Mirror polished chrome plating / Polie chromée / Verchromt geschliffen / Cromate lucide / Cromado polido / Полированный хром

COD.	AF mm	AF inch	L (mm)	A (mm)	B (mm)	C (mm)	g		
61882	18	-	210	26	26	41	340		
61883	19	3/4 *	220	28	28	44	400		•
61884	20	25/32 *		30	30	45	470		
61885	21		230				500		
61886	22		245	32	32	48	600		
61887	23	29/32 *	255	33	33		700		
61888	24		265	34	34	55	800		
61889	25		280	36	36		1000		
61890	26		290	37	37			6	A
61891	27	1.1/16 *	300	38	38	60	1200		
61892	28		310	39	39		1300		
61893	29	1.9/64 *	320	41	41		1500		
61894	30	1.3/16 *	330	42	42		1800		
61895	32		360	45	45	65	2000		
61768	34		375	48	48		2200		
61772	36		395	50	50				
61770	38		400			70			

Medidas aproximadas / Approximate measurements / Mesures approximatives | DIN 475

CARACTERÍSTICAS / FEATURES / CARACTÉRISTIQUES

12 x 6

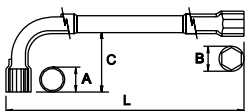
INCH

COD.	AF inch	L (mm)	A (mm)	B (mm)	C (mm)	g		
58143	3/8	130	15	15	24	90		
58144	1/2	150	19	19	30	170		
58145	5/8	180	24	24	37	270		•
58146	11/16	200	26	26	40	320		
58148	7/8	245	34	34	50	650		
58147	15/16	255	28		55	660		

Medidas aproximadas / Approximate measurements / Mesures approximatives | DIN 475

CARACTERÍSTICAS / FEATURES / CARACTÉRISTIQUES

6 x 6

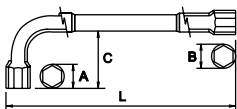
MM

COD.	AF mm	AF inch	L (mm)	A (mm)	B (mm)	C (mm)	g		
61166	5,5	7/32	110	11	11	18	50		
61170	6								
61171	7		115	12	12	21			
61172	8	5/16	120	13	13	22	60		
61173	9		125	14	14	26	70		
61174	10	25/64	130	16	16	27	100		•
61175	11	7/16	135	17	17	26	140		
61176	12	15/32	145	18	18	27	160		
61177	13		150	19	19	30	170		
61178	14	35/64	160	21	21	33	230		

A Cromado pulido espejo / Mirror polished chrome plating / Polie chromée / Verchromt geschliffen / Cromate lucide / Cromado pulido / Полированный хром

COD.	AF mm	AF inch	L (mm)	A (mm)	B (mm)	C (mm)	g		
61179	15		175	22	22	35	230		
61180	16		185	24	24	39			
61181	17		200	25	25	39	290		
61182	18		210	26	26	41	340		
61183	19	3/4	220	28	28	44	400		
61184	20	25/32	230	30	30	45	470		
61185	21		240	32	32	48	500		
61186	22		240	32	32	48	600		
61187	23	29/32	250	33	33	55	700		
61188	24		260	34	34	55	800		
61189	25		280	36	36	60	1000		6
61190	26		290	37	37	60	1200		
61191	27	1.1/16	300	38	38	60	1300		
61192	28		310	39	39	65	1500		
61193	29	1.9/64	320	41	41	65	1800		
61194	30	1.3/16	330	42	42	65	2000		
61195	32		360	45	45	70	2200		
61769	34		370	48	48	70			
61773	36		390	50	50	70			
61771	38		400	50	50	70			

TITACROM® | Medidas aproximadas / Approximate measurements / Mesures approximatives | DIN 475

CARACTERÍSTICAS / FEATURES / CARACTÉRISTIQUES

6 x 6

KIT-8 PCS.
MM

COD.	PCS.		COD. PCS.	(mm)
68597	A	8	90057	61872, 61874, 61875, 61877, 61881, 61883, 61886, 61888
68598	C	8	90057	61172, 61174, 61175, 61177, 61181, 61183, 61186, 61188

KIT-10 PCS.
MM

COD.	PCS.		COD. PCS.	(mm)
69351	A	10	90058	61872, 61873, 61874, 61875, 61876, 61877, 61878, 61881, 61883, 61885
69353	C	10	90058	61172, 61173, 61174, 61175, 61176, 61177, 61178, 61181, 61183, 61185

MM

COD.	PCS.		COD. PCS.	(mm)
68599	A	10	90054	61872, 61874, 61875, 61876, 61877, 61878, 61880, 61881, 61882, 61883
68600	C	10	90054	61172, 61174, 61175, 61176, 61177, 61178, 61180, 61181, 61182, 61183



KIT-15 PCS.
MM

COD.	PCS.		COD. PCS.	(mm)		
68601	A	15	90061	61872, 61874, 61875, 61876, 61877, 61878, 61879, 61880, 61881, 61882, 61883, 61885, 61886, 61887, 61888	8-10-11-12-13-14-15-16-17-18-19-21-22- 23-24	12 x 6
68602	C			61172, 61174, 61175, 61176, 61177, 61178, 61179, 61180, 61181, 61182, 61183, 61185, 61186, 61187, 61188	6 x 6	

KIT-22 PCS.
MM

COD.	PCS.		COD. PCS.	(mm)		
68603	A	22	90167	61872, 61873, 61874, 61875, 61876, 61877, 61878, 61879, 61880, 61881, 61882, 61883, 61885, 61886, 61887, 61888, 61890, 61891, 61892, 61893, 61894, 61895	8-9-10-11-12-13-14-15-16-17-18-19-21-22- 23-24-26-27-28-29-30-32	12 x 6
68604	C			61172, 61173, 61174, 61175, 61176, 61177, 61178, 61179, 61180, 61181, 61182, 61183, 61185, 61186, 61187, 61188, 61190, 61191, 61192, 61193, 61194, 61195	6 x 6	

EXPOSITORES / DISPLAYS / PRESENTOIRS / DISPLAY / ESPOSITORI / DISPLAY STAND / СТЕНДЫ
54 PCS.
MM

COD.	PCS.	COD. PCS.	(mm)
55570	A	54	12 x 6
	PCS.	COD. PCS.	
	6	61872	8 mm
		61873	9 mm
		61874	10 mm
		61875	11 mm
		61876	12 mm
		61877	13 mm
	4	61878	14 mm
		61881	17 mm
		61883	19 mm
		61885	21 mm



MM

COD.	PCS.	COD. PCS.	(mm)
55571	C	54	6 x 6
	PCS.	COD. PCS.	
	6	61172	8 mm
		61173	9 mm
		61174	10 mm
		61175	11 mm
		61176	12 mm
		61177	13 mm
	4	61178	14 mm
		61181	17 mm
		61183	19 mm
		61185	21 mm

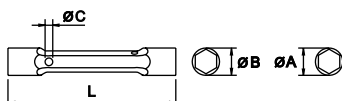

DE TUBO DOBLE BOCA / SOCKET DOUBLE ENDED / CLÉ À TUBE FORGÉE DROITE / DOPPEL-STECKSCHLÜSSEL / CHIAVI A TUBO / DIRITTE TUBOLARES BOCA DUPLA / ДВОЙНАЯ ГОЛОВКА

MM



COD.	AF mm	L (mm)	A (mm)	B (mm)	Ø C (mm)	g		
61824	6-7	105	10	11		30		
61825	8-9	110	13	14	3	50		
61826	10-11	120	15	16	5	80		
61827	12-13	140	18	19	6	140		
61828	14-15	145	20	22	6	155	10	•
61829	16-17	155	23	24	7	180		
61830	18-19	165	25	26	8	230		
61831	20-22	170	28	30	8	290		
61832	21-23	185	29	31	10	340		
61833	24-26	190	33	33		430		
61838	24-27	190	33	35	12	430	6	-
61834	25-28	200	34	37	12	500	6	-
61835	27-29	210	37	39		550		
61836	30-32	210	40	42	13	700		



TITACROM® | DIN 896-A

PASADOR ESCALONADO / STEP TOMMY BAR / BROCHE POUR CLÉ À TUBE / STUFEN-DREHSTIFT FÜR DOPPEL-STECKSCHLÜSSEL / PUNZONE SFALSAIO / PASSADOR ESCALONADO / ВОРОТОК СТУПЕНЧАТЫЙ

MM

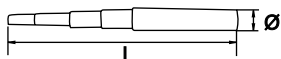

COD.	L (mm)	O.D. mm	g
61794	180	2,5-4,5-5,5-6	30
61795	280	6,5-7,5-9,5-11,5-12,5-13	200



SET

MM

COD.	PCS.		COD. PCS.	(mm)
69489	6	90052	61824, 61825, 61826, 61827, 61828, 61829	6-7, 8-9, 10-11, 12-13, 14-15, 16-17
69272	8	90057	61824, 61825, 61826, 61827, 61828, 61829, 61830, 61831	6-7, 8-9, 10-11, 12-13, 14-15, 16-17, 18-19, 20-22

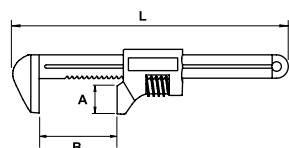

LLAVE DE CREMALLERA / AUTO WRENCH / CLÉ À CREMAILLÈRE / VERSTELLBARE ROHRZANGE / CHIAVE A CREMAGLIERA / CHAVE DE CREMALHEIRA / РАЗВОДНОЙ КЛЮЧ АВТОМОБИЛЬНЫЙ

COD.	L (mm)	L (inch)	A (mm)	B (mm)	g	
62028	230	9	30	68	500	5
62029	280	11	41	75	750	
62030	375	15	49	90	1500	1

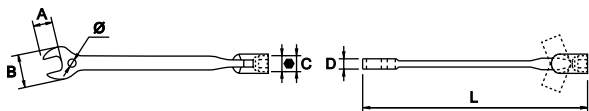

LLAVES ARTICULADAS / SWIVEL WRENCHES / CLÉS ARTICULÉES / SCHWENKSCHLÜSSEL / CHIAVI ARTICOLATE / CHAVES ARTICULADAS / КЛЮЧИ С ШАРНИРНЫМИ ГОЛОВКАМИ
LLAVE COMBINADA CON VASO ARTICULADO / FLEXIBLE SOCKET COMBINATION SPANNER / CLÉ MIXTE À DOUILLE ARTICULÉE / MAUL GELENK STECKSCHLÜSSEL / CHIAVI COMBINATE CON BUSSOLA ARTICOLATA / CHAVE COMBINADA COM CAIXA ARTICULADA / КОМБИНИРОВАННЫЙ КЛЮЧ

MM

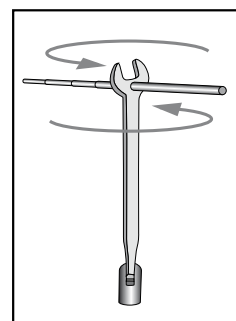

COD.	AF mm	L (mm)	A (mm)	B (mm)	C (mm)	D (mm)	O.D. mm	g	Icon 1	Icon 2
56190	10	180	12	25	15	5,5		95		
56191	11	190	14	27	17	6		115		
56192	12	215	15	31	18	6,5	6	145	10	●
56193	13				150					
56194	14	220	16	32	20	8	7	185		
56195	15				230					
56196	17	235	19	38	24	9	7	230		
56197	19	250	20	41	26	9	7	320		

PASADOR ESCALONADO / STEP TOMMY BAR / BROCHE POUR CLÉ À TUBE / STUFEN-DREHSTIFT FÜR DOPPEL-STECKSCHLÜSSEL / PUNZONE SFALSATO / PASSADOR ESCALONADO / ВОРОТОК СТУПЕНЧАТЫЙ

MM

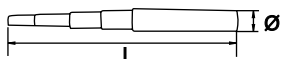

COD.	L (mm)	O.D. mm	g
61794	180	2,5-4,5-5,5-6	30
61795	280	6,5-7,5-9,5-11,5-12,5-13	200

DE VASO DOBLE ARTICULACIÓN / DOUBLE ENDED SWIVEL / CLÉ À TUBE ARTICULÉE / DOPPEL-GELENKSTECKSCHLÜSSEL / CHIAVE A BUSSOLA DOPPA SNODABILE / DE CAIXA ARTICULADAS / КЛЮЧ ДВОЙНАЯ ГОЛОВКА ШАРНИРНАЯ

MM

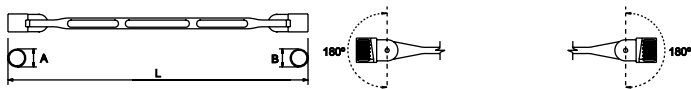

COD.	AF mm	L (mm)	A (mm)	B (mm)	g	Icon 1	Icon 2
61301	8-9	200	12	13	100		
61302	10-11	210	15	16	110		
61303	12-13	230	19	19	155	10	
61304	14-15	240	21	21	200		
61305	16-17	250	23	24	280		
61306	18-19	270	26	26	390		
61308	20-22	290	28	30	480	5	
61309	21-23		32	32	470		
61310	24-27	330	32	36	700		



■ KIT-6

■ MM

COD.	PCS.	COD. PCS.	(mm)		
69185	6	61301, 61302, 61303, 61304, 61305, 61306	8-9, 10-11, 12-13, 14-15, 16-17, 18-19 mm	1,6	●



DE BUJÍA ARTICULADA / SPARK PLUG WRENCH / CLÉS À BOUGIE ART. / ZÜNDKERZENSCHLÜSSEL / CHIAVI PER CANDELE SNODABILE / CHAVE ARTICULADA PARA VELAS / СВЕЧНОЙ КЛЮЧ

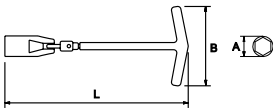

COD.		L (mm)	A (mm)	B (mm)			
61471	20-13/16	230	28	100	250	8	●

DIN 3112



EXTENSIBLE PARA RUEDAS / EXTENSIBLE WHEEL WRENCH / CLÉS À ROUES EXTENSIBLE / AUSZIEHBARER RADMUTTERNSCHLÜSSEL / CHIAVE ESTENSIBILE PER RUOTE / EXTENSÍVEL PARA RODAS / РАЗДВИЖНОЙ БАЛОННЫЙ КЛЮЧ

■ MM

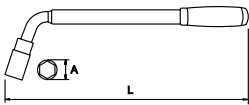

COD.		L (mm)	A (mm)		
61476	17-19	550	28	800	3

DIN 3112



LLAVES ARTICULADAS EN T / T-HANDLE WRENCHES WITH UNIVERSAL JOINT / CLÉ À BEQUILLE ARTICULÉE / KARDAN GELENKSCHLÜSSEL / CHIAVE A T CON SNODO CARDANICO / CHAVES T COM CARDAN / Т-ОБРАЗНЫЙ КЛЮЧ С ШАРНИРНОЙ ГОЛОВКОЙ

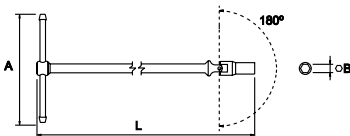

COD.			L (mm)	A (mm)	B (mm)			
61840	6	-	390	165	10	220	10	●
61841	7	-			11			
61842	8	5/16 *			12			
61843	9	11/32 *			14			
61844	10	-			15			
61845	11	-	450	180	17	480	●	
61846	12	15/32 *			18			
61847	13	1/2 *			19			
61848	14	-			20			
61849	15	19/32 *			22			
61850	16	5/8 *	500	230	23	850	●	
61851	17	21/32 *			24			
61852	18	-			25			
61853	19	3/4 *			27			
61854	20	25/32 *			28			
61855	21	13/16 *	29					
61856	22	-	31					
61858	24	15/16 *	33					



Medidas aproximadas / Approximate measurements / Mesures approximatives

EN CRUZ PLEGABLE / FOLDING CROSS RIM WRENCH / CLÉ EN CROIX Pliable / KREUZSCHLÜSSEL, KLAPPBAR / CHIAVE A CROCE PIEGABILE / CHAVE EM CRUZ DOBRAVEL / СКЛАДНОЙ БАЛОННЫЙ КЛЮЧ

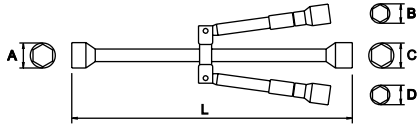

COD.	AF mm	L (mm)	A (mm)	B (mm)	C (mm)	D (mm)	g	
61477	17-19-21-23	355	30	26	32	28	1300	1



EN CRUZ / CROSS RIM WRENCH / CLÉ EN CROIX / KREUZSCHLÜSSEL / CHIAVE A CROCE / CHAVE DE CRUZETA / КРЕСТОБРАЗНЫЙ БАЛОННЫЙ КЛЮЧ

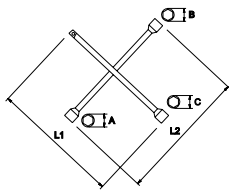

COD.	AF mm	AF inch	L1 (mm)	L2 (mm)	A (mm)	B (mm)	C (mm)	g	
61475	17-19-22	1/2	350	350	28	26	31	1150	1

DIN 3119



LLAVE FIJA CROWFOOT / OPEN END CROWFOOT WRENCH / CLÉ À FOURCHE CROWFOOT / EINSTECK-MAULSCHLÜSSEL / CHIAVE FISSA CROWFOOT / PONTEIRA DE BOCA COM QUADRADO INTERIOR / РОЖКОВЫЙ КЛЮЧ С КВАДРАТОМ

■ 1/4"

■ MM

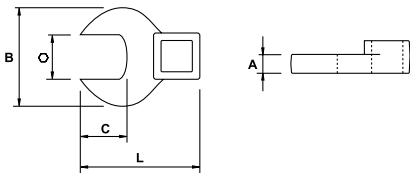

COD.	AF mm	L (mm)	A (mm)	B (mm)	C (mm)	g		
57211	7	30	6	25	6	70	10	●
57212	8	31		26	7			
57213	9	33		28	8			
57214	10	35		30	9			
57215	11	36	7	31	11	90		
57216	12	38		34	12			
57217	13	39		35	13			

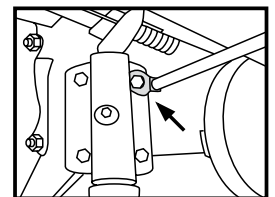

INCH

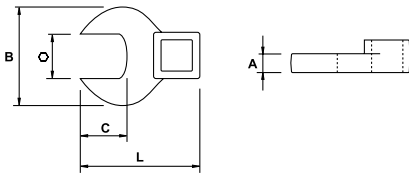

COD.	AF inch	L (mm)	A (mm)	B (mm)	C (mm)	g		
57218	5/16	31		26	7	70		
57219	3/8	33	6	28	8			
57220	7/16	35		30	9	75	10	•
57221	1/2	38	7	34	12	92		
57222	9/16	39		36	14	100		

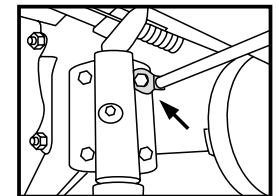

3/8"

MM

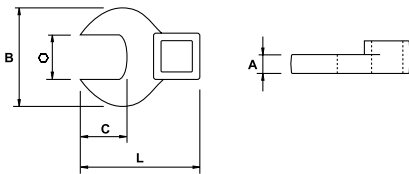

COD.	AF mm	L (mm)	A (mm)	B (mm)	C (mm)	g		
55710	10	36	6	24	10	28		
55711	11	39	6,5	26	13	35		
55712	12	40	7,2	28	14	40		
55713	13	42	8,3	30	15	41		
55714	14	46	8,4	34	17	50		
55715	15	48	8,8	36	18	56	10	•
55716	16	50	9	40	21	62		
55717	17	55	9,5	46	22,5	80		
55718	19	55	9,5	46	23,5	100		
55719	21	65	10	54	25,5	140		
55720	22				26,5	200		
55721	24				25,5			
55722	25				26,5			
55723	27				28,5			

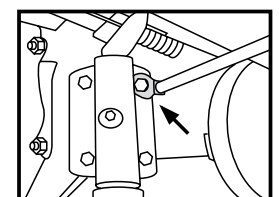

INCH

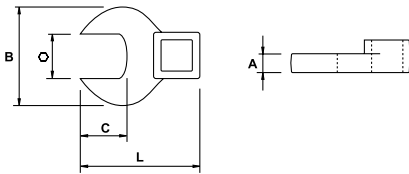

COD.	AF inch	L (mm)	A (mm)	B (mm)	C (mm)	g		
55724	3/8	36	6	24	10	28		
55725	7/16	39	6,5	26				
55726	1/2	40	7,2	28	14	40		
55727	9/16	42	8,3	30				
55728	5/8	46	8,4	34	17	50		
55729	11/16	48	8,8	36	18	56		
55730	3/4	50	9	40	21	62	10	●
55731	13/16				21,5	80		
55732	7/8	55	9,5	46	22,5	100		
55733	15/16				25,5	140		
55734	1	65	10	54	26,5			
55735	1.1/16				28,5	200		

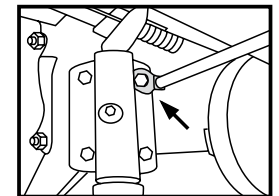

1/2"

MM

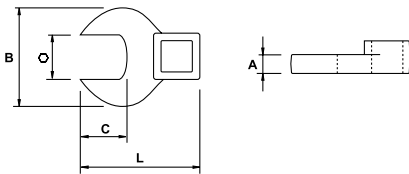

COD.	AF mm	L (mm)	A (mm)	B (mm)	C (mm)	g		
57224	20			42	19	150		
57225	21	50						
57226	22			43	20			
57227	23	55		45	21			
57228	24			46	22	160		
57229	25		12	47	23			
57230	26	60		49	24	185		
57231	27			50	25	190		
57232	28	65		55	26	200		
57233	29				27			
57234	30				28	210		
57235	31	70		60	29	220		
57236	32				30	230		
57237	33			65	31	250	10	●
57238	34				32	260		
57239	35	75			33			
57240	36			70	34	270		
57241	37				35			
57242	38	80		75	36	280		
57243	39		14		37	290		
57244	40				38	300		
57245	41	85		80	39	320		
57246	42				40			
57247	43				41	330		
57248	44	90		85	42	340		
57249	45				43	360		
57250	46	95	15	90	44	380		

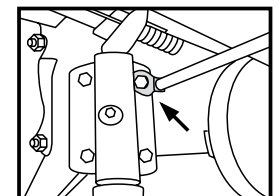

■ INCH

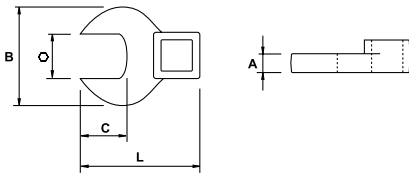

COD.	AF inch	L (mm)	A (mm)	B (mm)	C (mm)	g		
57251	15/16	55	12	45	21	160	10	●
57252	1	60		47	23			
57253	1.1/16	60		50	25	190		
57254	1.1/8	65		50	26	200		
57255	1.3/16	70		60	28	210		
57256	1.1/4	70		65	30	230		
57257	1.5/16	75		70	31	250		
57258	1.3/8	75	70	33	260			
57259	1.7/16	80	14	70	34	270		
57260	1.1/2	80		75	36	280		
57261	1.9/16	85		75	37	290		
57262	1.5/8	85		80	39	320		
57263	1.11/16	90		84	41	330		
57264	1.3/4	90		84	42	340		
57265	1.13/16	95		90	44	380		
57266	1.7/8	95	90	45	400			
57267	1.15/16	100	95	46	430			
57268	2	100	95	49	460			
57269	2.1/16	100	15	95	49	480		
57270	2.1/8	105		100	50	500		
57271	2.3/16	105		100	50	600		
57272	2.1/4	105		105	55	650		
57273	2.5/16	110		105	55	700		
57274	2.3/8	110		110	60	750		
57275	2.7/16	110		110	60	750		
57276	2.1/2	110	110	60	850			

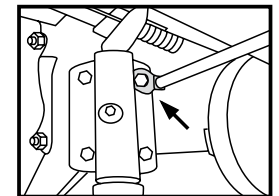

EGGA *Master*
ART IN INNOVATION

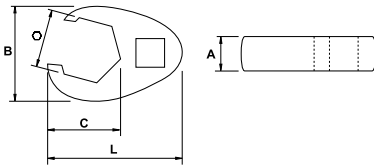
LLAVE HEXAGONAL CROWFOOT / HEXAGONAL CROWFOOT WRENCH / CLÉ MÂLE CROWFOOT / SECHSKANT-EINSTECK-MAULSCHLÜSSEL / CHIAVE ESAGONALE CROWFOOT / PONTEIRA HEXAGONAL COM QUADRADO INTERIOR / РОЖКОВЫЙ ШЕСТИГРАННЫЙ КЛЮЧ С КВАДРАТОМ
3/8"
MM

COD.	AF mm	L (mm)	A (mm)	B (mm)	C (mm)	g		
55736	10				16	28		
55737	11	38	7,8	31				
55738	12		8		18	35		
55739	13					40		
55740	14					41		
55741	15	41	9	33	21	50		
55742	16						10	•
55743	17	45			24	56		
55744	19	46	10,5	36	25	62		
55745	21					80		
55746	22	50	11	40	28,5	100		
55747	24					140		
55748	25	55	11,5	45	34			
55749	27					200		

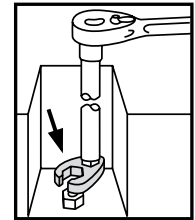
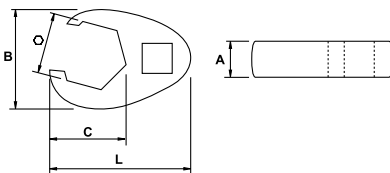
INCH

COD.	AF inch	L (mm)	A (mm)	B (mm)	C (mm)	g		
55750	3/8				16	28		
55751	7/16	38	7,8	31				
55752	1/2		8		18	40		
55753	9/16	41	9	33	21	41		
55754	5/8					50		
55755	11/16	46	10,5	36	24	56		
55756	3/4					62	10	•
55757	13/16	50	11	40	28,5	80		
55758	7/8					100		
55759	15/16					140		
55760	1	55	11,5	45	34			
55761	1.1/16					200		

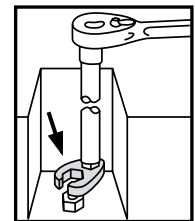

ADAPTADOR DE PAR / TORQUE ADAPTER / АДАПТАТЕУР ДЕ КУПЛЕ / DREHMOMENT ADAPTOR / ADATTATORE DI COPPIA / ADAPTADOR DE PAR / АДАПТЕР КРУТЯЩЕГО МОМЕНТА

3/8"

MM

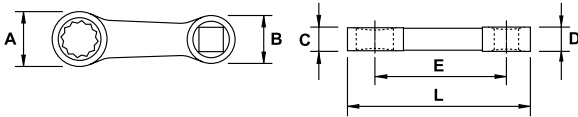

COD.	AF mm	AF inch	L (mm)	A (mm)	B (mm)	C (mm)	D (mm)	E (mm)	g	Icon 1	Icon 2
57315	8							51			
57316	10	3/8	73	20	19	9	12	52	61	10	●
57317	13			24		11,5					



INCH

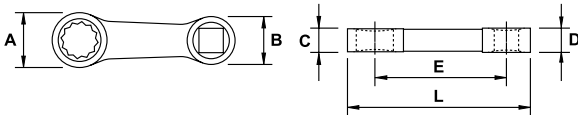

COD.	AF inch	AF inch	L (mm)	A (mm)	B (mm)	C (mm)	D (mm)	E (mm)	g	Icon 1	Icon 2
57318	5/16							51			
57319	3/8			20		9					
57320	7/16	3/8	73		19		12	52	61	10	●
57321	1/2			24		12					
57322	9/16										



SPLINE

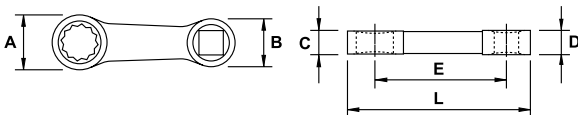





COD.	AF inch	AF inch	L (mm)	Spline	A (mm)	B (mm)	C (mm)	D (mm)	E (mm)	g	Icon 1	Icon 2
57323	7/32			M7								
57324	1/4			M8								
57325	9/32			M9								
57326	5/16			M10	20		9		51			
57327	3/8	3/8	73	M12		19		12	52	10	●	
57328	7/16			M14								
57329	1/2			M16								
57330	9/16			M18	24		12		61			
57331	5/8			M20								



■ LLAVES EN "L" / "L" KEYS / CLÉS EN "L" / "L" FORM SCHLÜSSEL / CHIAVI ESAGONALI / CHAVES EM L / ШЕСТИГРАННЫЕ КЛЮЧИ
■ LLAVES HEXAGONALES / HEXAGONAL KEYS / CLÉS MÂLES / INBUSSCHLÜSSEL / CHIAVI ESAGONALI / CHAVES HEXAGONAIS / ШЕСТИГРАННИК
EGA

■ STANDARD

■ MM

COD.		L (mm)	A (mm)			
65302	0,9	33	10	0,2		
65955	1,27	40	12	0,9		
61501	1,5	46	14	1,0		
61502	2	50	16	2,0		
61503	2,5	60	17	3,0		
65956	2,7	55		4,5		
61504	3	65	20	5,0		
65303	3,5	70	21	7,5		
61505	4	75	25	10		
65304	4,5	80	26	14		
61506	5	85	28	15		
61507	5,5			25		
61508	6	95	32	30		
61527	7		33	45		
61509	8	100	36	60	10	●
65305	9	115	38	80		
61510	10	120	40	105		
65306	11	130		130		
65307	12	135	42	170		
65519	13	145	44	190		
65308	14	155	46	260		
65958	15	160		310		
65309	16	170	50	370		
65310	17	175		440		
65959	18	190	65	500		
65311	19			650		
65960	20	200	70	660		
65312	21	210		800		
65313	22	220	82	950		
65314	24	250	90	1250		
65961	27	280	100	1750		
65962	30	320	110	2450	5	
65963	32	350	120	3050		
65964	36	390	135	4350		
67629	38		140	4700		
67630	41	380	150	5700		
67631	46		160	7000		
67632	48	410	165	7100		
67633	50		175	9550	1	
67634	55	450	185	11200		
67635	60	470	195	14050		
67636	65	480	200	15300		
67637	70	500	210	16700		

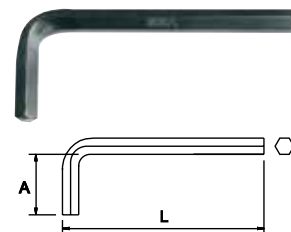

ISO 2936 | DIN 911

CARACTERÍSTICAS / FEATURES / CARACTÉRISTIQUES

Cr-V

INCH

COD.	AP inch	L (mm)	A (mm)	g		
65315	1/16	46	15	0,9		
65316	5/64	50	18	2,0		
65317	3/32	60	20	3,0		
65318	1/8	65	23	5,0		
65319	5/32	75	29	10		
65320	3/16	85	33	15		
65321	7/32	95	38	25		
65322	1/4	100	44	30	10	
65323	5/16	120	50	60		
65324	3/8	130	55	105		
65325	7/16	140	70	170		
65326	1/2	155	75	260		
65327	9/16	170	90	370		
65328	5/8	200	90	650		
65329	3/4	240	90	950		
67614	7/8	260	110	1250	5	
67615	1	270	110	1750		
67616	1.1/8	320	120	3050		
67617	1.1/4	380	150	5700	1	
67618	1.5/8					

ISO 2936 | DIN 911

CARACTERÍSTICAS / FEATURES / CARACTÉRISTIQUES

Cr-V

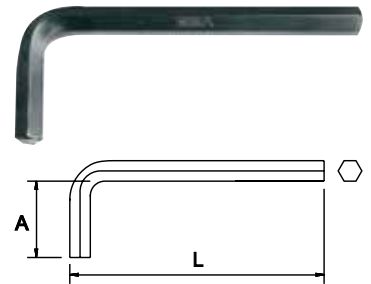

SERIE LARGA / LONG PATTERN / SÉRIE LONGUE / LANGE SERIE / SERIE LUNGA / SERIE LONGA / ДЛИННЫЙ

MM

COD.	AP mm	L (mm)	A (mm)	g		
61517	1,5	65	15	1,0		
61518	2	75	18	2,0		
61519	2,5	85	20	4,0		
61520	3	95	23	7,0		
67298	3,5	100	25	10		
61521	4	105	29	15		
67299	4,5	115	30	19		
61522	5	120	33	25		
61523	5,5	130	38	35		
61524	6	140	41	40		
61557	7	150	44	60		
61525	8	160	47	80	10	
65330	9	170	50	115		
61526	10	180	55	140		
65331	11	190	70	200		
65332	12	200	75	260		
67300	13	210	80	300		
67301	14	230	80	400		
67302	15	240	80	460		
67303	16	260	80	500		
67304	17	280	90	650		
67305	19	310	100	850		
67306	22	360	115	1300	1	
67307	24			1750		

ISO 2936 | DIN 911

CARACTERÍSTICAS / FEATURES / CARACTÉRISTIQUES

Cr-V

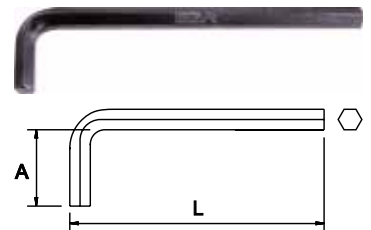

INCH

COD.	AP inch	L (mm)	A (mm)	g		
68900	1/16		14	1,6		
68901	5/64	80	16	2,7		
68902	3/32	85	17	4,5		
68903	7/64	90	18	6,6		
68904	1/8	95	19	8,3		
68905	9/64	100	20	11		
68906	5/32	105	21	14	10	
68907	3/16	115	24	23		
68908	7/32	125	26	32		
68909	1/4	135	29	50		
68910	5/16	150	32	80		
68911	3/8	170	35	135		
68912	7/16	190	38	210		
67671	1/2	210	43	370	6	
67672	5/8	250	50	690		
67653	3/4	290	55	1300		
67654	7/8	350	65	1750		
67655	1	400	70	2300		
67656	1.1/8	450	85	3750	1	
67657	1.1/4	490	140	5800		
67673	1.1/2	550	150	7100		
67658	1.5/8	570	160	8800		

ISO 2936 | DIN 911

CARACTERÍSTICAS / FEATURES / CARACTÉRISTIQUES

Cr-V

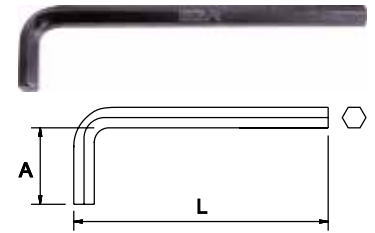
BOLA SERIE LARGA / LONG PATTERN BALLPOINT / SÉRIE LONGUE À TÊTE SPHÉRIQUE / KUGELKOPF- INBUSSCHLÜSSEL / SERIE LUNGA CON TESTA SFERICA / ESFERICAS, SERIE LONGA / ДЛИННЫЙ С ШАРОВОЙ ГОЛОВКОЙ

MM

COD.	AP mm	L (mm)	A (mm)	g		
61615	1,5	65	15	1,0		
61616	2	75	18	2,0		
61617	2,5	85	20	3,0		
61618	3	95	23	5,0		
61619	4	105	29	10		
61620	5	120	33	15	10	
61621	5,5	130	38	25		
61622	6	140	40	30		
67493	7	150	44	60		
61623	8	160	45	110		
67494	9	170	50	140		
61624	10	180	55	250		
67495	12	200	60	400	1	
67496	14	230	60	650		
67497	17	260	67	850		
67498	19	280				



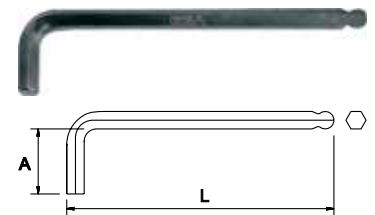

ISO 2936 | DIN 911

CARACTERÍSTICAS / FEATURES / CARACTÉRISTIQUES

Cr-V



INCH



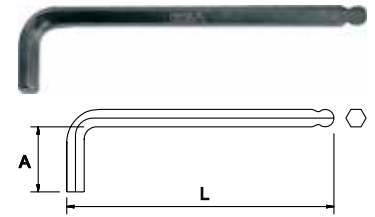

COD.		L (mm)	A (mm)			
68914	1/16	75	14	1,6		
68915	5/64	80	16	2,7		
68916	3/32	85	17	4,5		
68917	7/64	90	18	6,6		
68918	1/8	95	19	8,3		
68919	9/64	100	20	11		
68920	5/32	105	21	14	10	●
68921	3/16	115	24	23		
68922	7/32	125	26	32		
68923	1/4	135	29	50		
68924	5/16	150	32	80		
68925	3/8	170	35	135		
68926	7/16	190	38	210		

ISO 2936 | DIN 911





CARACTERÍSTICAS / FEATURES / CARACTÉRISTIQUES

Cr-V

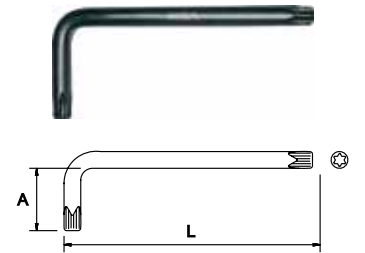
LLAVES TORX / TORX** KEYS / CLÉS TORX** / TORX** INBUSSCHLÜSSEL / CHIAVI TORX** / CHAVES TORX** / КЛЮЧ TORX****
STANDARD

COD.		L (mm)	A (mm)			
67801	T-6					
67802	T-7					
67803	T-8	41	14	2,5		
67804	T-9					
65333	T-10	49	16	3,5		
65334	T-15	56	17	5,0		
65335	T-20	62	19	7,5	10	●
65336	T-25	70	20	9,5		
65337	T-27	75	24	15		
65338	T-30	85	29	20		
65339	T-40	95	34	32		
65340	T-45	110	39	44		
65341	T-50	125	41	65		



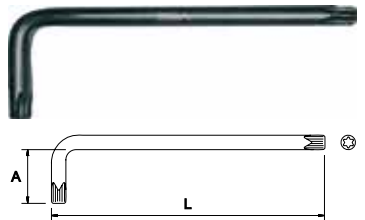

SERIE LARGA / LONG PATTERN / SÉRIE LONGUE / LANGE SERIE / SERIE LUNGA / SERIE LONGA / ДЛИННЫЙ

COD.		L (mm)	A (mm)			
65342	T-10	90	17	6,0		
65343	T-15	95	18	9,0		
65344	T-20	100	19	12		
65345	T-25	105	20	16		
65346	T-27	110	21	24	10	●
65347	T-30	120	24	31		
65348	T-40	130	26	46		
65349	T-45	140	28	65		
65350	T-50	160	32	90		







*Para tornillos TORX® (Marca registrada por Acument Intellectual Properties, LLC, Troy, Mich., US) / *For screws TORX® (Acument Intellectual Properties, LLC, Troy, Mich., US registered trademark) / *Pour vis TORX® (Marque enregistrée par Acument Intellectual Properties, LLC, Troy, Mich., US)

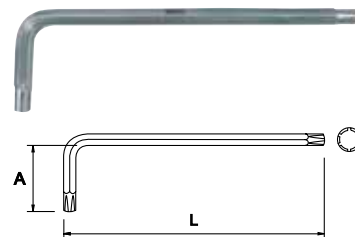



■ LLAVES RIBE® / RIBE® WRENCHES / CLÉS RIBES® / RIBE® SCHLÜSSEL / CHIAVE RIBE® / CHAVES RIBE® / КЛЮЧИ RIBE®

COD.		L (mm)	A (mm)			
65975	M4	145	22	16		
65976	M5	150	24	26		
65977	M6	160	30	42	10	•
65978	M7	175	32	80		
65979	M8	185	40	90		
65980	M10	220	55	150		

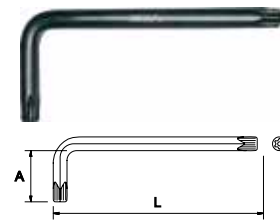
■ LLAVES TAMPER TORX / TAMPER TORX KEYS / CLÉS TAMPER TORX / TAMPER TORX INBUSSCHLÜSSEL / CHIAVI TAMPER TORX / CHAVES TAMPER TORX / КЛЮЧ TAMPER TORX

COD.		L (mm)	A (mm)			
56544	TT8	41	14	2,5		
56545	TT9					
56546	TT10	49	16	3,5		
56547	TT15	56	17	5		
56548	TT20	62	19	7,5		
56549	TT25	70	20	9,5	10	•
56550	TT27	75	24	15		
56551	TT30	85	29	20		
56552	TT40	95	34	32		
56553	TT45	110	39	44		
56554	TT50	125	41	65		

■ SERIE LARGA / LONG PATTERN / SÉRIE LONGUE / LANGE SERIE / SERIE LUNGA / SERIE LONGA / ДЛИННЫЙ

COD.		L (mm)	A (mm)			
56556	TT10	90	17	6		
56557	TT15	95	18	9		
56558	TT20	100	19	12		
56559	TT25	105	20	16		
56560	TT27	110	21	24	10	•
56561	TT30	120	24	31		
56562	TT40	130	26	46		
56563	TT45	140	28	65		
56564	TT50	160	32	90		

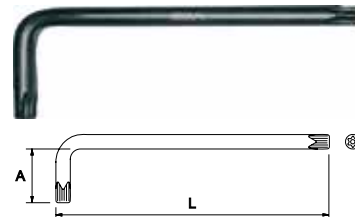

EGGA Master

ART IN INNOVATION

JUEGOS / SETS / ASSORTIMENTS / SÄTZE / ASSORTIMENTI / JOGOS / НАБОРЫ

61600	10	400	10	●
Composición / Composition / Composition				
61502-61504-61505-61506-61508-61509-61510-65306-65519-65308			2-3-4-5-6-8-10-11-13-14	
61767	15	650	10	●
Composición / Composition / Composition				
61502-61504-61505-61506-61508-61527-61509-65305-61510-65306-55307-65519-65310-65311-65313			2-3-4-5-6-7-8-9-10-11-12-13-17-19-22	
69987	7	600	6	●
Composición / Composition / Composition				
65975, 65976, 65977, 65978, 65979, 65980			M4, M5, M6, M7, M8, M9, M10	
61499	8	105	12	●
Composición / Composition / Composition				
61501, 61502, 61503, 61504, 61505, 61506, 61507, 61508			1,5-2-2,5-3-4-5-5,5-6 mm	
61500	10	270	12	●
Composición / Composition / Composition				
61501, 61502, 61503, 61504, 61505, 61506, 61507, 61508, 61509, 61510			1,5-2-2,5-3-4-5-5,5-6-8-10 mm	
61516	10	270	12	●
Composición / Composition / Composition				
65315, 65316, 65317, 65318, 65319, 65320, 65321, 65322, 65323, 65324			1/16"-5/64"-3/32"-1/8"-5/32"-3/16"-7/32"-1/4"-5/16"-3/8"	
61512	7	330	12	●
Composición / Composition / Composition				
61519, 61520, 61521, 61522, 61524, 61525, 61526			Serie larga / Long serie 2,5-3-4-5-6-8-10 mm	
61496	10	360	12	●
Composición / Composition / Composition				
61615, 61616, 61617, 61618, 61619, 61620, 61621, 61622, 61623, 61624			Serie larga / Long serie 1,5-2-2,5-3-4-5-5,5-6-8-10 mm	



COD.	PCS.			
61495	10	360	12	●

Composición / Composition / Composition	Descripción / Description / Description	
68914, 68915, 68916, 68918, 68920, 68921, 68922, 68923, 68924, 68925	Serie larga / Long serie	1/16"-5/64"-3/32"-1/8"-5/32"-3/16"-7/32"-1/4"-5/16"-3/8"



COD.	PCS.			
65351	9	250	12	●

Composición / Composition / Composition	Descripción / Description / Description
65333, 65334, 65335, 65336, 65337, 65338, 65339, 65340, 65341	T10-T15-T20-T25-T27-T30-T40-T45-T50



COD.	PCS.			
65665	9	300	6	●

Composición / Composition / Composition	Descripción / Description / Description	
65342, 65343, 65344, 65345, 65346, 65347, 65348, 65349, 65350	Serie larga / Long serie	T10-T15-T20-T25-T27-T30-T40-T45-T50



COD.	PCS.			
65650	9	250	12	●

Composición / Composition / Composition	Descripción / Description / Description
56546, 56547, 56548, 56549, 56550, 56551, 56552, 56553, 56554	TT10-TT15-TT20-TT25-TT27-TT30-TT40-TT45-TT50



COD.	PCS.			
56566	9	300	6	●

Composición / Composition / Composition	Descripción / Description / Description	
56556, 56557, 56558, 56559, 56560, 56561, 56562, 56563, 56564	Serie larga / Long serie	TT10-TT15-TT20-TT25-TT27-TT30-TT40-TT45-TT50

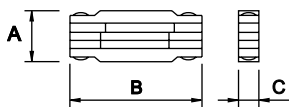

COD.	PCS.	A (mm)	B (mm)	C (mm)	Composición / Composition / Composition				
61511	8	39	120	32	2-2,5-3-4-5-6-8-10 mm	290	12	●	●

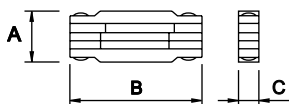

COD.	PCS.	A (mm)	B (mm)	C (mm)	Composición / Composition / Composition				
61514	6	21	95	32	2,5-3-4-5-6-8 mm	160	12	●	●



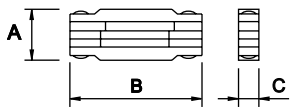

COD.	PCS.	A (mm)	B (mm)	C (mm)	Composición / Composition / Composition				
61513	6	33	90	17	T10-T15-T20-T25-T27-T30	90	12	•	

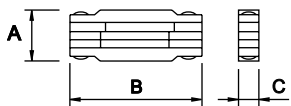

COD.	PCS.	A (mm)	B (mm)	C (mm)	Composición / Composition / Composition				
56567	6	33	90	17	TT10-TT15-TT20-TT25-TT27-TT30	90	12	•	



COD.	PCS.	Composición / Composition / Composition	COD. PCS.				
65352	8	1,5 - 2 - 2,5 - 3 - 4 - 5 - 6 - 8 mm	61501, 61502, 61503, 61504, 61505, 61506, 61508, 61509	140	12	•	
65353		5/64 - 3/32 - 1/8 - 5/32 - 3/16 - 7/32 - 1/4 - 5/16	65316, 65317, 65318, 65319, 65320, 65321, 65322, 65323	150			
65354		T9-T10-T15-T20-T25-T27-T30-T40	67804, 65333, 65334, 65335, 65336, 65337, 65338, 65339	140			
56568		TT9-TT10-TT15-TT20-TT25-TT27-TT30-TT40	56545, 56546, 56547, 56548, 56549, 56550, 56551, 56552	140			

